

ACP-IMX6POS

Freescale i.MX6 Cortex-A9 Dual Lite/ Quad 1GHz

User's manual

3rd Ed – 11 March 2015

Distributed by:



www.texim-europe.com

Part No. E2047IMX602R

FCC Statement



THIS DEVICE COMPLIES WITH PART 15 FCC RULES. OPERATION IS SUBJECT TO THE FOLLOWING TWO CONDITIONS:

(1) THIS DEVICE MAY NOT CAUSE HARMFUL INTERFERENCE.

(2) THIS DEVICE MUST ACCEPT ANY INTERFERENCE RECEIVED INCLUDING INTERFERENCE THAT MAY CAUSE UNDESIRE OPERATION.

THIS EQUIPMENT HAS BEEN TESTED AND FOUND TO COMPLY WITH THE LIMITS FOR A CLASS "A" DIGITAL DEVICE, PURSUANT TO PART 15 OF THE FCC RULES.

THESE LIMITS ARE DESIGNED TO PROVIDE REASONABLE PROTECTION AGAINST HARMFUL INTERFERENCE WHEN THE EQUIPMENT IS OPERATED IN A COMMERCIAL ENVIRONMENT. THIS EQUIPMENT GENERATES, USES, AND CAN RADIATE RADIO FREQUENCY ENERGY AND, IF NOT INSTALLED AND USED IN ACCORDANCE WITH THE INSTRUCTION MANUAL, MAY CAUSE HARMFUL INTERFERENCE TO RADIO COMMUNICATIONS.

OPERATION OF THIS EQUIPMENT IN A RESIDENTIAL AREA IS LIKELY TO CAUSE HARMFUL INTERFERENCE IN WHICH CASE THE USER WILL BE REQUIRED TO CORRECT THE INTERFERENCE AT HIS OWN EXPENSE.

Notice

This guide is designed for experienced users to setup the system within the shortest time. For detailed information, please always refer to the electronic user's manual.

Copyright Notice

Copyright © 2015 Avalue Technology Inc., ALL RIGHTS RESERVED.

No part of this document may be reproduced, copied, translated, or transmitted in any form or by any means, electronic or mechanical, for any purpose, without the prior written permission of the original manufacturer.

Trademark Acknowledgement

Brand and product names are trademarks or registered trademarks of their respective owners.

Disclaimer

Avalue Technology Inc. reserves the right to make changes, without notice, to any product, including circuits and/or software described or contained in this manual in order to improve design and/or performance. Avalue Technology assumes no responsibility or liability for the use of the described product(s), conveys no license or title under any patent, copyright, or masks work rights to these products, and makes no representations or warranties that these products are free from patent, copyright, or mask work right infringement, unless

2 ACP-IMX6POS User's Manual

ACP-IMX6POS User's Manual

otherwise specified. Applications that are described in this manual are for illustration purposes only. Avalue Technology Inc. makes no representation or warranty that such application will be suitable for the specified use without further testing or modification.

Life Support Policy

Avalue Technology's PRODUCTS ARE NOT FOR USE AS CRITICAL COMPONENTS IN LIFE SUPPORT DEVICES OR SYSTEMS WITHOUT THE PRIOR WRITTEN APPROVAL OF Avalue Technology Inc.

As used herein:

1. Life support devices or systems are devices or systems which, (a) are intended for surgical implant into body, or (b) support or sustain life and whose failure to perform, when properly used in accordance with instructions for use provided in the labeling, can be reasonably expected to result in significant injury to the user.
2. A critical component is any component of a life support device or system whose failure to perform can be reasonably expected to cause the failure of the life support device or system, or to affect its safety or effectiveness.

A Message to the Customer

Avalue Customer Services

Each and every Avalue's product is built to the most exacting specifications to ensure reliable performance in the harsh and demanding conditions typical of industrial environments. Whether your new Avalue device is destined for the laboratory or the factory floor, you can be assured that your product will provide the reliability and ease of operation for which the name Avalue has come to be known.

Your satisfaction is our primary concern. Here is a guide to Avalue's customer services. To ensure you get the full benefit of our services, please follow the instructions below carefully.

Technical Support

We want you to get the maximum performance from your products. So if you run into technical difficulties, we are here to help. For the most frequently asked questions, you can easily find answers in your product documentation. These answers are normally a lot more detailed than the ones we can give over the phone. So please consult the user's manual first.

To receive the latest version of the user's manual; please visit our Web site at:

<http://www.avalue.com.tw/>

ACP-IMX6POS User's Manual

Product Warranty

Avalue warrants to you, the original purchaser, that each of its products will be free from defects in materials and workmanship for two years from the date of purchase.

This warranty does not apply to any products which have been repaired or altered by persons other than repair personnel authorized by Avalue, or which have been subject to misuse, abuse, accident or improper installation. Avalue assumes no liability under the terms of this warranty as a consequence of such events. Because of Avalue's high quality-control standards and rigorous testing, most of our customers never need to use our repair service. If any of Avalue's products is defective, it will be repaired or replaced at no charge during the warranty period. For out-of-warranty repairs, you will be billed according to the cost of replacement materials, service time, and freight. Please consult your dealer for more details. If you think you have a defective product, follow these steps:

1. Collect all the information about the problem encountered. (For example, CPU type and speed, Avalue's products model name, hardware & BIOS revision number, other hardware and software used, etc.) Note anything abnormal and list any on-screen messages you get when the problem occurs.
2. Call your dealer and describe the problem. Please have your manual, product, and any helpful information available.
3. If your product is diagnosed as defective, obtain an RMA (return material authorization) number from your dealer. This allows us to process your good return more quickly.
4. Carefully pack the defective product, a complete Repair and Replacement Order Card and a photocopy proof of purchase date (such as your sales receipt) in a shippable container. A product returned without proof of the purchase date is not eligible for warranty service.
5. Write the RMA number visibly on the outside of the package and ship it prepaid to your dealer.

CONTENT

1. Getting Started	6
1.1 Safety Precautions	6
1.2 Packing List	6
1.3 Document Amendment History.....	7
1.4 Manual Objectives	8
1.5 System Specifications	9
1.6 Architecture Overview – Block Diagram	11
2. Hardware Configuration	12
2.1 Product Overview	13
2.2 Jumper and Connector List	14
2.3 Setting Jumpers & Connectors.....	16
2.3.1 Boot mode selector (JBTSL1)	16
2.3.2 Serial port connector 3/4 (JCOM3/4).....	17
2.3.3 USB connector 1 (JUSB1).....	17
2.3.4 USB connector 2 (JUSB2).....	18
2.3.5 LED connector (JLED1)	18
2.3.6 Touch Panel connector (JTP1).....	19
2.3.7 Speaker connector 1 (JSPK1).....	19
2.3.8 Speaker connector 2 (JSPK2).....	20
2.3.9 Line In, MIC connector (JMIC1)	20
2.3.10 LCD inverter connector (JBKLT1)	21
2.3.11 VGA connector (JVGA1)	21
2.3.12 LVDS connector (JLVDS1).....	22
2.3.13 Debug UART connector (JUART1)	23
2.3.14 Battery holder (BAT-1)	23
2.3.15 I2C device connector (JI2C1).....	24
3. Software User Guide	25
3.1 Download Android Source Code for building image file	26
3.2 Set up for building Android image file	26
3.3 Building up Android image file	27
3.4 Use MfgTool to flash Android into onboard eMMC	29

1. Getting Started

1.1 Safety Precautions

Warning!



Always completely disconnect the power cord from your chassis whenever you work with the hardware. Do not make connections while the power is on. Sensitive electronic components can be damaged by sudden power surges. Only experienced electronics personnel should open the PC chassis.

Caution!



Always ground yourself to remove any static charge before touching the CPU card. Modern electronic devices are very sensitive to static electric charges. As a safety precaution, use a grounding wrist strap at all times. Place all electronic components in a static-dissipative surface or static-shielded bag when they are not in the chassis.

1.2 Packing List

Before you begin installing your single board, please make sure that the following materials have been shipped:

- 1 x ACP-IMX6POS Module

1.3 Document Amendment History

Revision	Date	Comment
1 st	July 2014	Initial Release
2 nd	November 2014	Update System Specifications
3 rd	March 2015	Update Block Diagram

1.4 Manual Objectives

This manual describes in detail the Avalue Technology ACP-IMX6POS Single Board.

We have tried to include as much information as possible but we have not duplicated information that is provided in the standard IBM Technical References, unless it proved to be necessary to aid in the understanding of this board.

We strongly recommend that you study this manual carefully before attempting to interface with ACP-IMX6POS series or change the standard configurations. Whilst all the necessary information is available in this manual we would recommend that unless you are confident, you contact your supplier for guidance.

Please be aware that it is possible to create configurations within the CMOS RAM that make booting impossible. If this should happen, clear the CMOS settings, (see the description of the Jumper Settings for details).

If you have any suggestions or find any errors concerning this manual and want to inform us of these, please contact our Customer Service department with the relevant details.

1.5 System Specifications

System	
CPU	Freescale i.MX6 Cortex-A9 Dual Lite/ Quad 1GHz
System Memory	Onboard Up to 1GB(Dual Lite) or 2GB(Quad) DDR3 1066/1333 SDRAM
SSD	4~8GB eMMC
G sensor	Freescale MMA8451 (Optional)
SD Card	Micro SD Socket x1
Watchdog Timer	Freescale i.MX6 Build-in
Expansion	1x Mini PCI Express slot (USB signal only) Supported WIFI & 3.5G module SIM card holder onboard Micro SD Socket x1 (in system access window area)
Touch Controller	Penmount 6000
RTC	I2C RTC Intersil ISL1208IB8Z
I/O	
Serial Port	4 x COM port supported (2 x Pin header , 2 x Edge I/O) All Pin 9 supported 5V/12V 1A max output, selected by GPIO. COM1 & 2: RS232/422/485 selected in GPIO, RS232 by Standard. COM3 & 4 Ping header
USB Port	1 x dual stack USB 2.0 port 1 x USB for USB touch controller 1 x USB for mini-PCIe socket 3 x USB pin header for optional function USB hub is SMSC USB2517
Switch	Pin header for Power Button (The first time auto power on)
Indicator Light	Front panel right side with PWR/ WIFI/ LAN
Others	1 x RJ11 connector for cash drawer (GPO select RJ11 power supply 12V or 24V)
Display	
Chipset	Freescale i.MX6
Resolution	Up to 1920 x 1080
Multiple Display	VGA + HDMI or LVDS + HDMI VGA signal is converted by Chrontel Ch7055A (Box header)
HDMI	From Freescale i.MX6
LCD Interface	Dual channel 24bit LVDS

ACP-IMX6POS User's Manual

Audio	
I2S Codec	Wolfson WM8962
Audio Port	2Pin Wafer Box P=2.0m x 2 (Speaker out R & L) (Driver per channel max 2W)
Mic	4Pin Wafer Box P=2.0m x 1(Microphone)
Ethernet	
LAN Chip	1 st LAN => from i.MX6 MAC, PHY is Micrel KSZ9031RNX 2 nd LAN => Intel 82574L by PCIe interface
Ethernet Interface	2 x RJ45 connectors for Dual G LAN
Internal I/O Connectors	
RTC Battery	CR2032 Battery with cable
Power ON	BOX header for Power Button (The first time auto power on)
Reset	BOX header for Reset Button
Audio	2P BOX header x 2 (Speaker out R & L) (Driver per channel max 2W)
Rear I/O Connectors	
USB	USB Type A Double Deck x 1
LAN	RJ45 connector with indicate LED x 2
HDMI	HDMI connector x 1 (Vertical type)
Mini-USB	Mini-USB connector x 1
RJ11	RJ11 connector x 1 for cash drawer
COM Port	DB9 male connector x 2
DC Jack	Wide range DC 12V to 24V power input by DC Jack connector
Mechanical & Environmental	
Power Requirement	TBD
Power Type	DC 12-24V power input
Operating Temp.	0~60 degree C
Storage Temp.	-40~85 degree C
Operating Humidity	12hrs operation dwell time at 40°C/80% Relative Humidity, Non-condensing
Size (L x W)	175 x 110mm
Weight	TBD



Note: Specifications are subject to change without notice.

1.6 Architecture Overview – Block Diagram

The following block diagram shows the architecture and main components of ACP-IMX6POS.

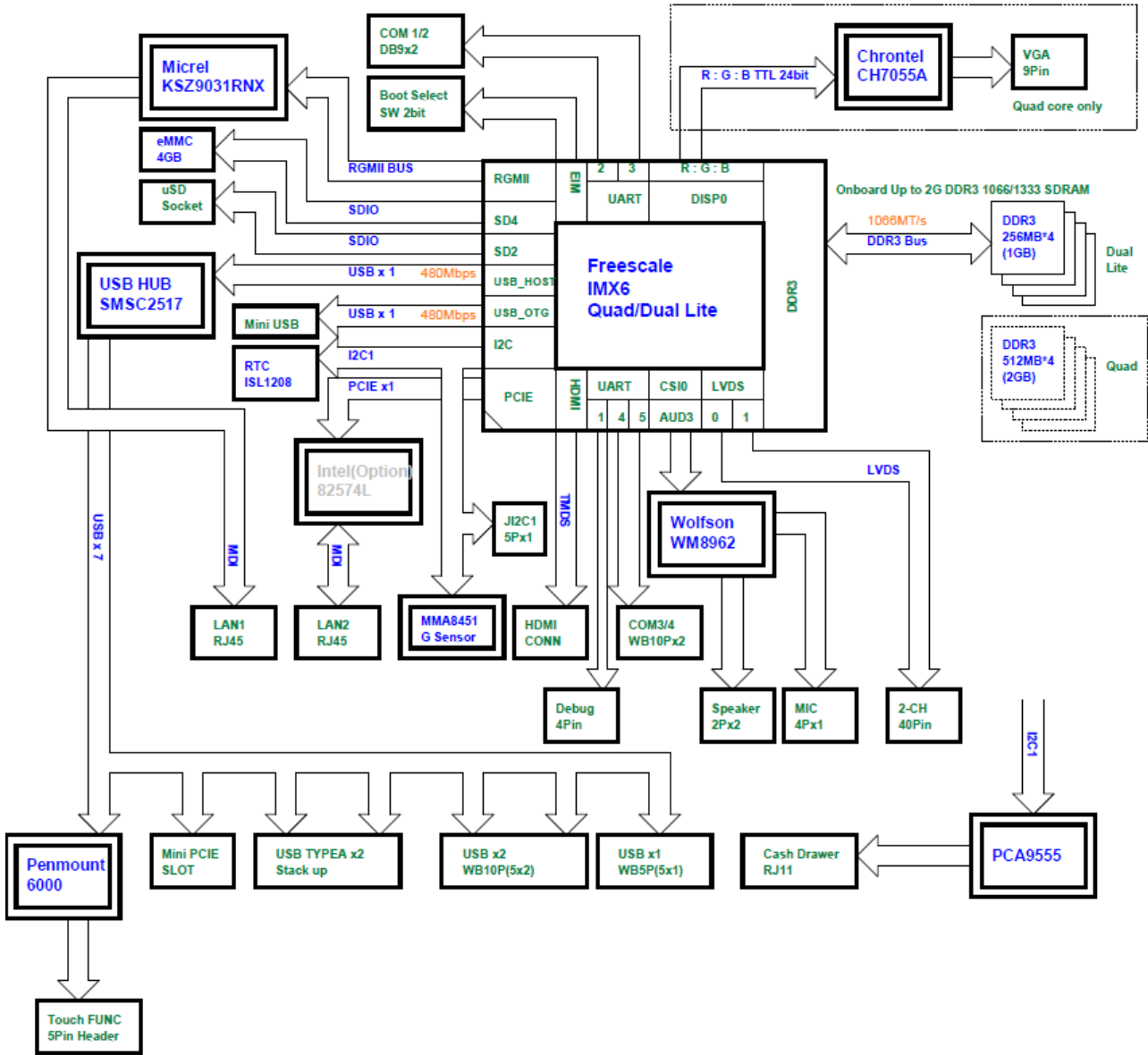

2. Hardware Configuration

2.1 Product Overview

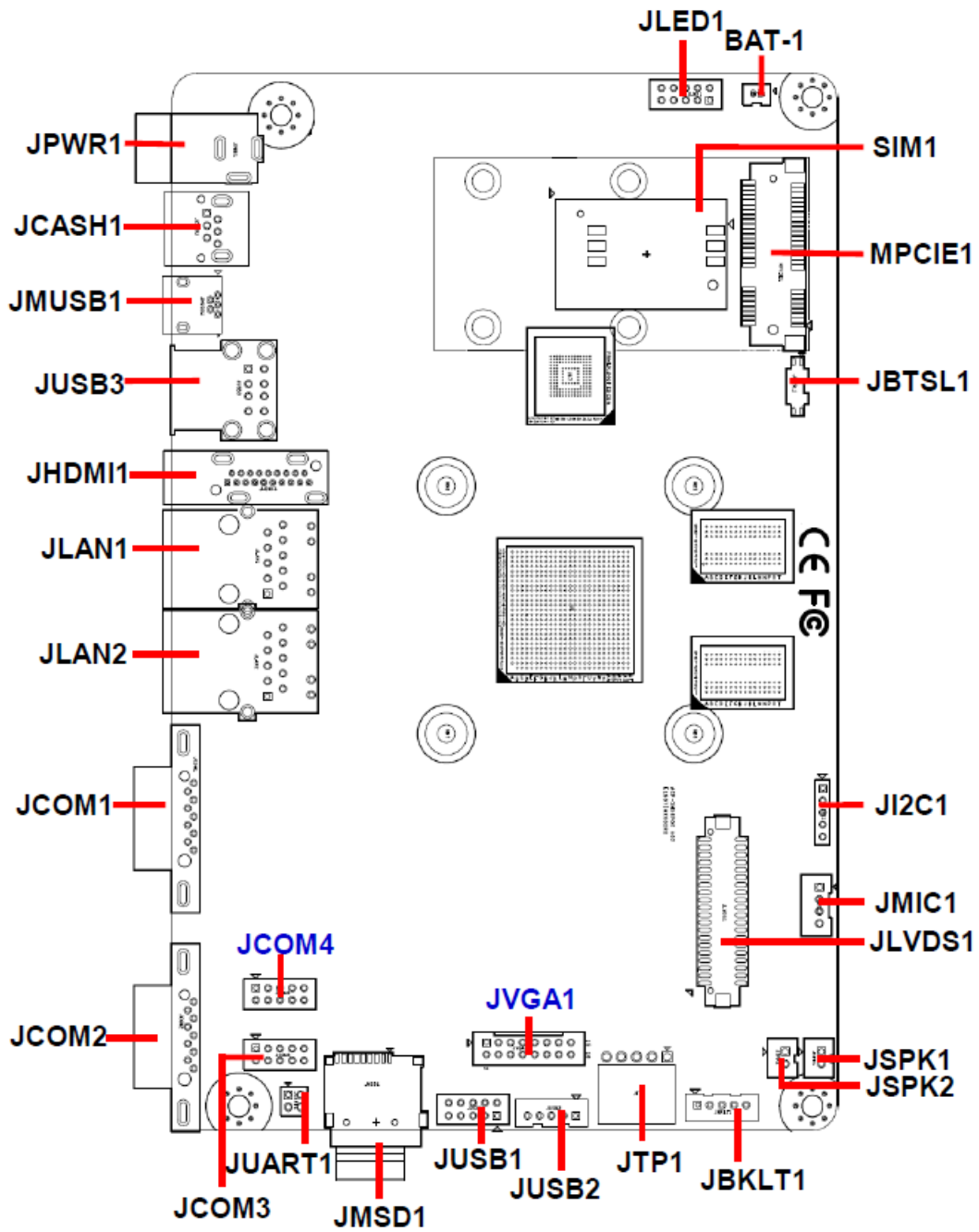

2.2 Jumper and Connector List

You can configure your board to match the needs of your application by setting jumpers. A jumper is the simplest kind of electric switch.

It consists of two metal pins and a small metal clip (often protected by a plastic cover) that slides over the pins to connect them. To “close” a jumper you connect the pins with the clip. To “open” a jumper you remove the clip. Sometimes a jumper will have three pins, labeled 1, 2, and 3. In this case, you would connect either two pins.

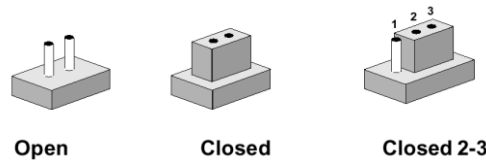

The jumper settings are schematically depicted in this manual as follows:



A pair of needle-nose pliers may be helpful when working with jumpers.

Connectors on the board are linked to external devices such as hard disk drives, a keyboard, or floppy drives. In addition, the board has a number of jumpers that allow you to configure your system to suit your application.

If you have any doubts about the best hardware configuration for your application, contact your local distributor or sales representative before you make any changes.

The following tables list the function of each of the board's jumpers and connectors.

Jumpers

Label	Function	Note
JBTSL1	Boot Mode selector	3 x 1 header, pitch 2.00mm

Connectors

Label	Function	Note
BAT-1	Battery holder	1 x 2 wafer, pitch 1.25mm
JCOM1/2	Serial port connector 1/2	D-sub 9-pin, male
JCOM3/4	Serial port connector 3/4	5 x 2 wafer, pitch 2.00 mm
JTP1	Touch Panel connector	5 x 1 header, pitch 2.54mm
JUSB3	USB connector 3	
JUSB1/2	USB connector 1/2	5 x 1 wafer, pitch 2.00mm
JMUSB1	Mini USB connector for Boot/Debug	MINI USB-MAB_5P



ACP-IMX6POS User's Manual

JPWR1	DC-IN power connector	Power Jack mini din 4P
MPCIE1	Mini PCI Express connector	
JCASH1	Cash Drawer	
JLAN1/2	RJ-45 Ethernet connector 1/2	
JVGA1	VGA connector	8 x 2 wafer, pitch 2.00mm
JLED1	LED connector	5 x 2 wafer, pitch 2.00mm
JSPK1/2	Speaker connector 1/2	2 x 1 wafer, pitch 2.00 mm
JLVDS1	LVDS connector	2 x 20 wafer, pitch 1.25 mm
SIM1	SIM Card Slot	SDCARD_9H, Push/Push Type
JMIC1	Line In, MIC connector	4 x 1 wafer, pitch 2.00mm
JBKLT1	LCD inverter connector	5 x 1 wafer, pitch 2.00mm
JMSD1	Micro SD Card Slot	
JUART1	Debug UART connector	Debug message output for users development phase only
JHDMI1	HDMI connector	
JI2C1	I2C device connector	5 x 1 header, pitch 2.00mm

2.3 Setting Jumpers & Connectors

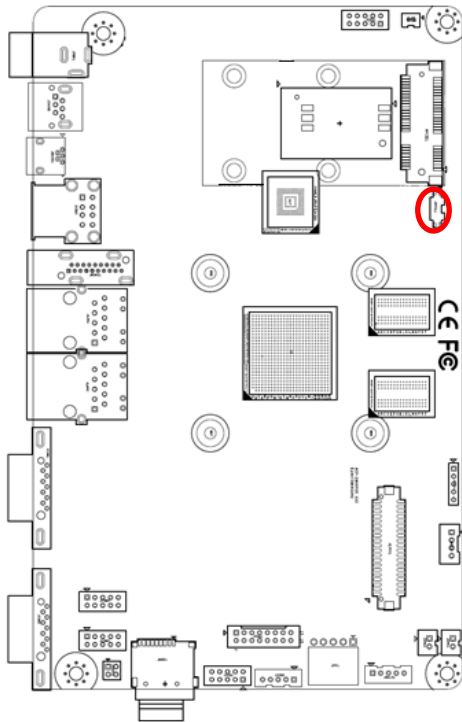
2.3.1 Boot mode selector (JBTS1)



Mode	Description
 21 on	OTG load
 21 on	eMMC boot
 21 on	SD boot

ACP-IMX6POS User's Manual

2.3.2 Serial port connector 3/4 (JCOM3/4)

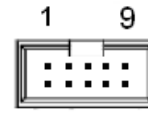
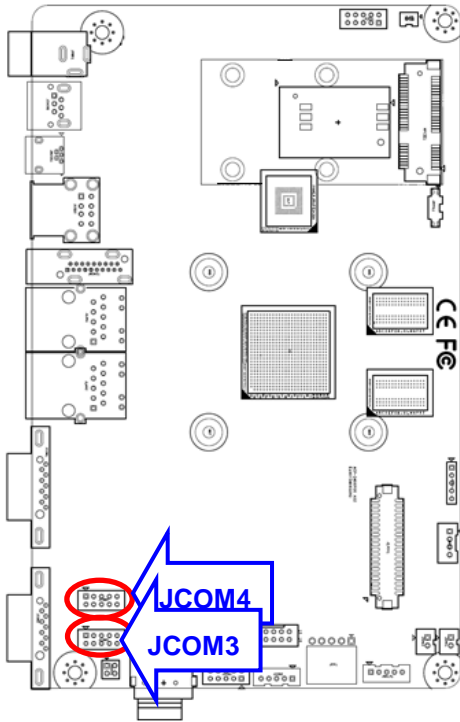

Signal	PIN	PIN	Signal
COM_DCD#	1	2	COM_RXD
COM_TXD	3	4	COM_DTR#
GND	5	6	COM_DSR#
COM_RTS#	7	8	COM_CTS#
COM_RI_A	9	10	GND

2.3.3 USB connector 1 (JUSB1)

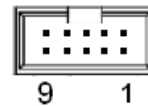
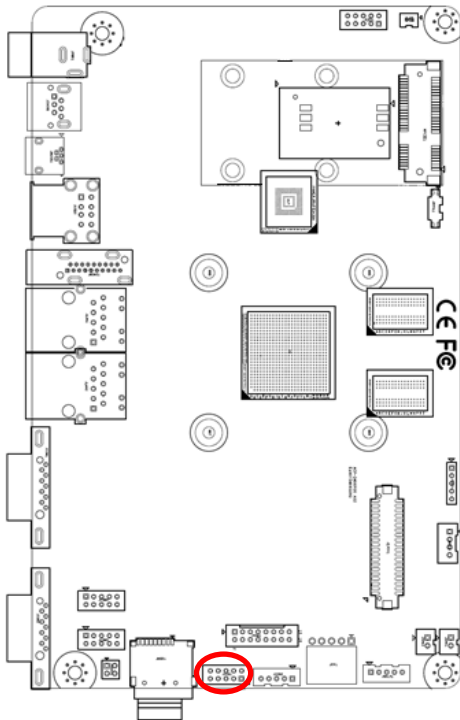

Signal	PIN	PIN	Signal
+5V	1	2	+5V
USB_NP2	3	4	USB_NP1
USB_PP2	5	6	USB_PP1
GND	7	8	GND
GND	9	10	GND

2.3.4 USB connector 2 (JUSB2)

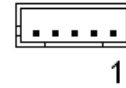
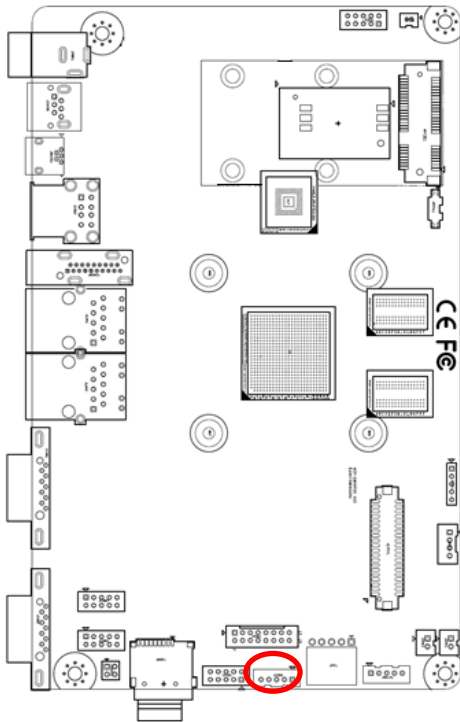

Signal	PIN
+5V	1
USB_NP3	2
USB_PP3	3
GND	4
GND	5

2.3.5 LED connector (JLED1)

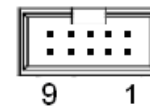
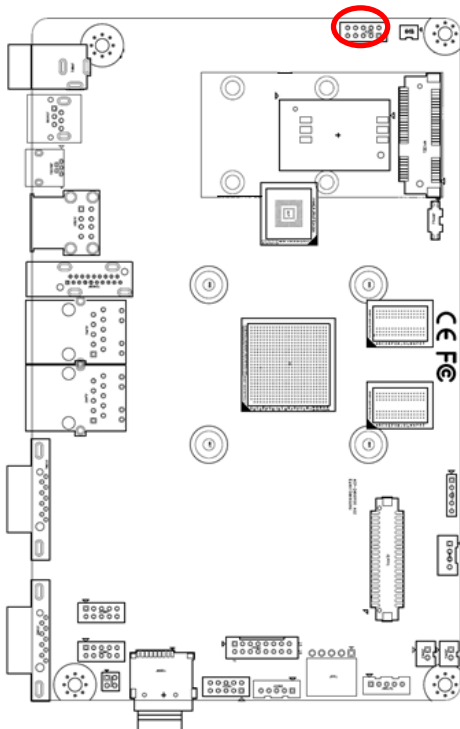

Signal	PIN
PWR-LED+	1
PWR-LED-	2
WIFI-LED+	3
WIFI-LED-	4
LAN-LED+	5
LAN-LED-	6
RESET	7
	8
ON/OFF	9
	10

2.3.6 Touch Panel connector (JTP1)

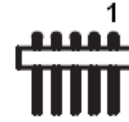
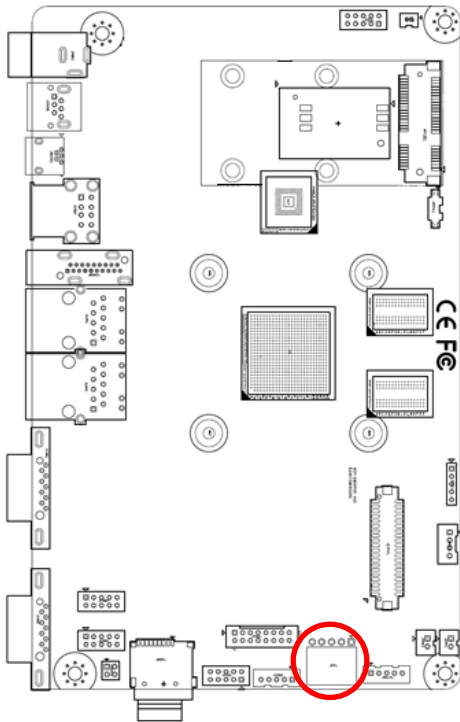

Signal	PIN
UL	1
UR	2
PROBE	3
LL	4
LR	5

2.3.7 Speaker connector 1 (JSPK1)

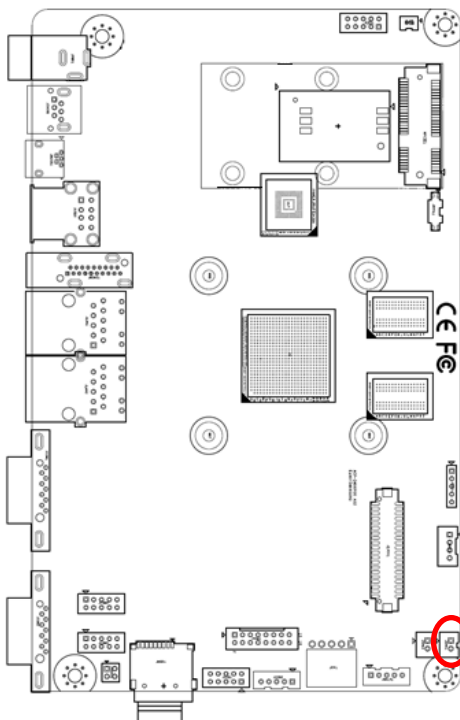

Signal	PIN
SPKL_N	1
SPKL_P	2

2.3.8 Speaker connector 2 (JSPK2)

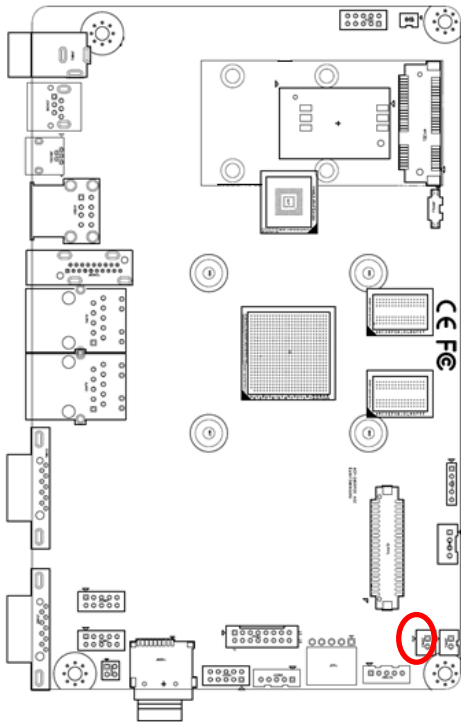

Signal	PIN
SPKR_N	1
SPKR_P	2

2.3.9 Line In, MIC connector (JM1C1)

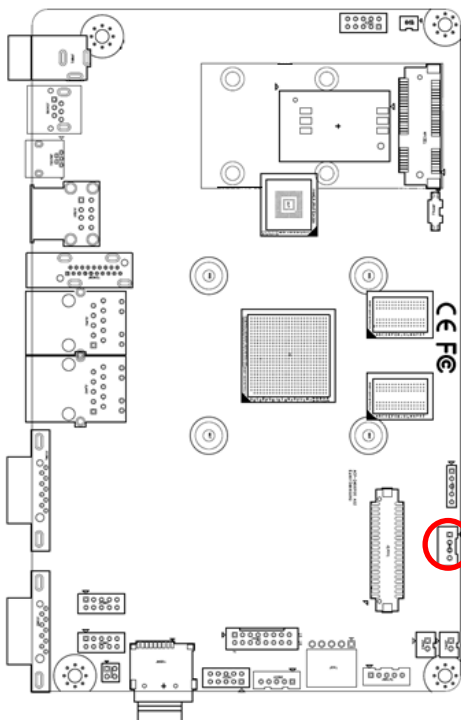

Signal	PIN
MIC_DET	1
MIC_IN	2
MICBIAS	3
GND	4

2.3.10 LCD inverter connector (JBKLT1)

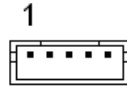
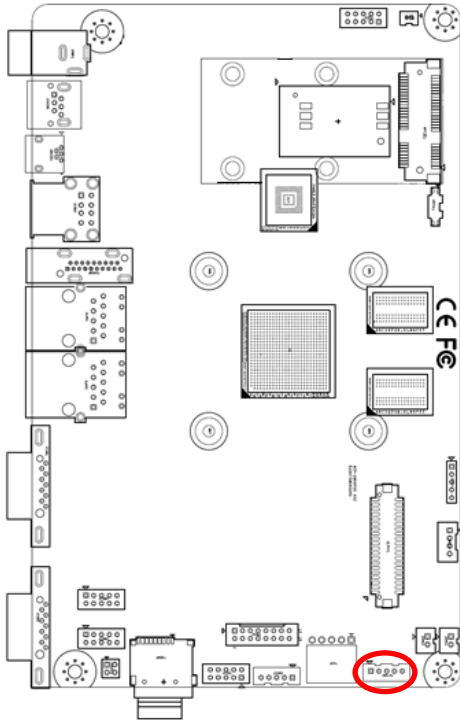

Signal	PIN
+12V	1
GND	2
BPEN(3.3V)	3
BKLCTL(3.3V)	4
+5V	5

2.3.11 VGA connector (JVGA1)

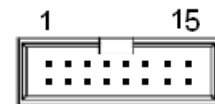
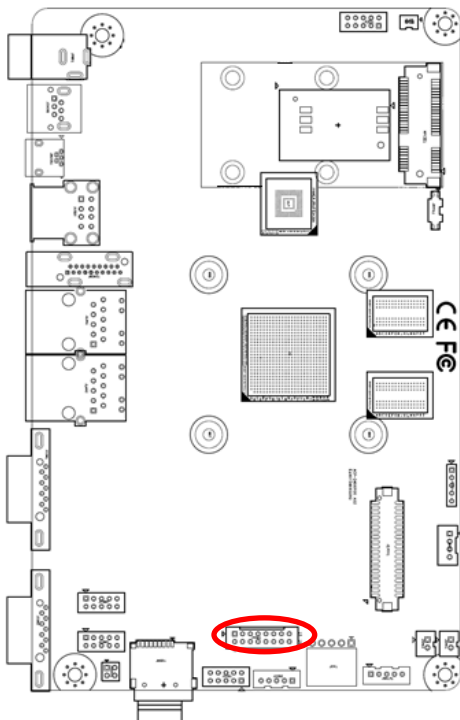

Signal	PIN	PIN	Signal
+5V	1	2	VRED
GND	3	4	VGREEN
NC	5	6	VBLUE
VDATA	7	8	NC
VHS	9	10	GND
VVS	11	12	GND
VCLK	13	14	GND
GND	15	16	GND

2.3.12 LVDS connector (JLVDS1)

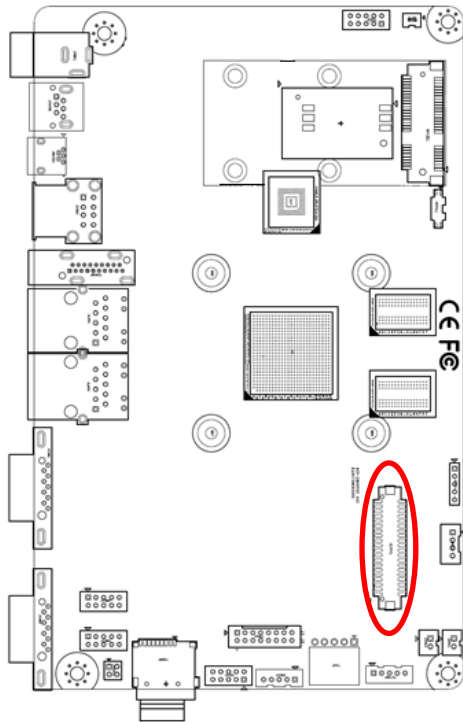

Signal	PIN	PIN	Signal
+12V	39	40	+12V
GND	37	38	GND
LVDS1_CLK_N	35	36	LVDS0_CLK_N
LVDS1_CLK_P	33	34	LVDS0_CLK_P
GND	31	32	GND
LVDS1_TX3_N	29	30	LVDS1_TX2_N
LVDS1_TX3_P	27	28	LVDS1_TX2_P
GND	25	26	GND
LVDS1_TX1_N	23	24	LVDS1_TX0_N
LVDS1_TX1_P	21	22	LVDS1_TX0_P
GND	19	20	GND
LVDS0_TX3_N	17	18	LVDS0_TX2_N
LVDS0_TX3_P	15	16	LVDS0_TX2_P
GND	13	14	GND
LVDS0_TX1_N	11	12	LVDS0_TX0_N
LVDS0_TX1_P	9	10	LVDS0_TX0_P
GND	7	8	GND
LVDS2_DDC_CLK	5	6	LVDS2_DDC_DATA
+3V	3	4	+5V
+3V	1	2	+5V

2.3.13 Debug UART connector (JUART1)

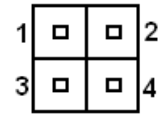
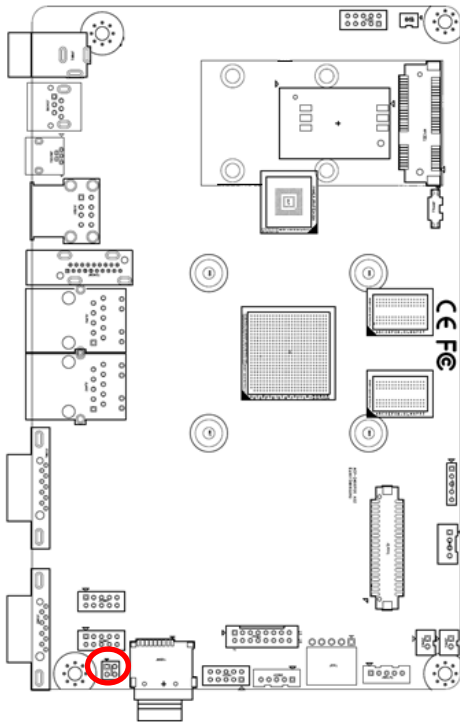

Signal	PIN	PIN	Signal
DBG_TX	1	2	GND
DBG_RX	3	4	GND

2.3.14 Battery holder (BAT-1)

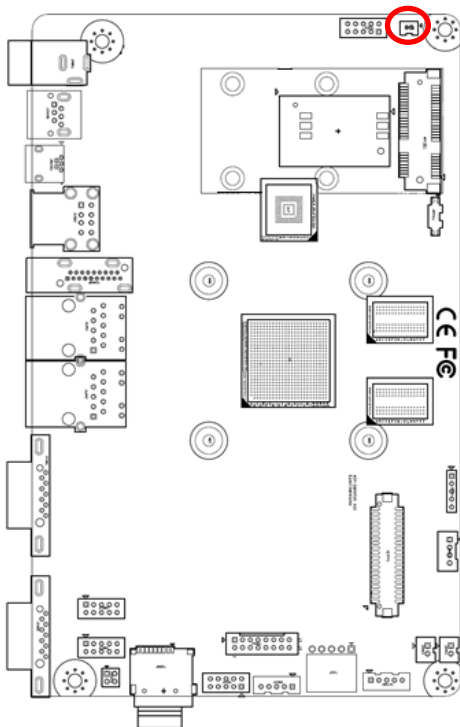

Signal	PIN
VBAT	1
GND	2

2.3.15 I2C device connector (J12C1)

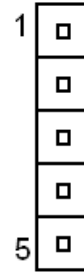

Signal	PIN
CS_+V3.3S	1
CS_INT#	2
CS_CLK	3
CS_DAT	4
GND	5

3. Software User Guide

3.1 Download Android Source Code for building image file

Please make a folder for storing the source code first then typing the command below to get started for the source code download.

```
$ sudo apt-get install git
```

```
$ git clone guest@202.55.227.57:freescala/imx6/Android.git -b 4.4.2-pos
```

About Password Please check with Avalue Sales or PM to get password.

3.2 Set up for building Android image file

We support to compile u-boot & Kernel on **Ubuntu 12.04** (64bit version), other version of Ubuntu is not currently supported and may have built issues.

Install host packages needed by building code. This document assumes you are using Ubuntu. Not a requirement, but the packages may be named differently and the method of installing them may be different.

- 1) Please follow up the commands below to install "Oracle JDK6.0" first for building up Android image file.

```
$ sudo apt-get install python-software-properties
```

```
$ sudo add-apt-repository ppa:webupd8team/java
```

```
$ sudo apt-get update
```

```
$ sudo apt-get install oracle-java6-installer
```

```
$ sudo update-alternatives --config java
```

- 2) Please follow up the commands below to install the necessary package for build image file.

```
$ sudo apt-get install git-core gnupg flex bison gperf build-essential \  
zip curl libc6-dev libncurses5-dev x11proto-core-dev gcc g++ \  
libx11-dev:i386 libreadline6-dev:i386 \  
libgl1-mesa-dev g++-multilib mingw32 openjdk-6-jdk tofrodos \  
python-markdown libxml2-utils xsltproc zlib1g-dev:i386 \  
ia32-libs u-boot-tools minicom lib32ncurses5-dev \  
uuid-dev liblzo2-dev libz-dev\  

```

3.3 Building up Android image file

You can follow up the steps below to compile Android image file after download the source code.

1. Please move to the folder "Android" then start to compile image file.

```
leo@ubuntu:~/imx6_Android$ ls
Android
leo@ubuntu:~/imx6_Android$ cd Android/
leo@ubuntu:~/imx6_Android/Android$
```

2. Type the command to compile image file.

```
$ ./run.sh -j16
```

(-j **number** means multi jobs for more efficient building, you can add it according to your CPU performance of PC, e.g. mine is "-j16" as below).

```
~/imx6_Android/Android$ ./run.sh -j16
```

3. You can find the finished image file(**u-boot-6q.bin**, **u-boot-6solo.bin**, **system.img**, **recover.img**, **boot.img**) as below after compiling on the directory **~/Android/out/target/product/smarc**.

```
leo@ubuntu:~/imx6_Android/Android/out/target/product/smarc$ ls -al
total 314160
drwxrwxr-x 9 leo leo 4096 Jan 2 23:44 .
drwxrwxr-x 3 leo leo 4096 Jan 2 22:09 ..
-rw-rw-r-- 1 leo leo 12 Jan 2 22:47 android-info.txt
-rw-r--r-- 1 leo leo 4784128 Jan 2 23:34 boot.img
-rw-rw-r-- 1 leo leo 29030 Jan 2 22:45 clean_steps.mk
drwxrwxr-x 4 leo leo 4096 Jan 2 23:36 data
-rw-rw-r-- 1 leo leo 53886 Jan 2 23:44 installed-files.txt
-rwxr-xr-x 1 leo leo 4593124 Jan 2 22:52 kernel
drwxrwxr-x 14 leo leo 4096 Jan 2 23:44 obj
-rw-rw-r-- 1 leo leo 373 Jan 2 22:45 previous_build_config.mk
-rw-rw-r-- 1 leo leo 186407 Jan 2 23:34 ramdisk.img
-rw-rw-r-- 1 leo leo 701522 Jan 2 23:34 ramdisk-recovery.img
drwxrwxr-x 3 leo leo 4096 Jan 2 23:34 recovery
-rw-r--r-- 1 leo leo 5298176 Jan 2 23:34 recovery.img
drwxrwxr-x 8 leo leo 4096 Jan 2 23:33 root
drwxrwxr-x 5 leo leo 4096 Jan 2 23:33 symbols
drwxrwxr-x 12 leo leo 4096 Jan 2 23:33 system
-rw-r--r-- 1 leo leo 293601280 Jan 2 23:44 system.img
drwxrwxr-x 3 leo leo 4096 Jan 2 23:19 test
-rwxr-xr-x 1 leo leo 445804 Jan 2 22:47 u-boot-6q.bin
-rwxr-xr-x 1 leo leo 445556 Jan 2 22:46 u-boot-6solo.bin
-rwxr-xr-x 1 leo leo 445804 Jan 2 22:47 u-boot.bin
-rwxr-xr-x 1 leo leo 4593188 Jan 2 22:52 uImage
-rw-r--r-- 1 leo leo 134217728 Jan 2 23:37 userdata.img
```

ACP-IMX6POS User's Manual

PS: If you would like to use **Mfgtool** for flashing image file into mainboard, you must put all the files **u-boot-6q.bin**, **u-boot-6solo.bin**, **system.img**, **recover.img**, **boot.img** under the path

“~\POS-Android-MfgTools\Image\POS\Android” on MFGTool folder for right detected.



3.4 Use MfgTool to flash Android into onboard eMMC

Manufacturing tool, a successor of ATK, provides a series of new features to power your mass production work. The features like windows style GUI, multiple devices support, explicit status monitoring, versatile functionalities and highly flexible architecture make it a best choice to meet your critical timing, cost and customization requirements.

For using Mfgtool to flash image file into onboard eMMC, please follow up the steps below

- 1) Please turn off all pins of DIP switch (**JBTSL1**) as below into burning mode of Mfgtool.

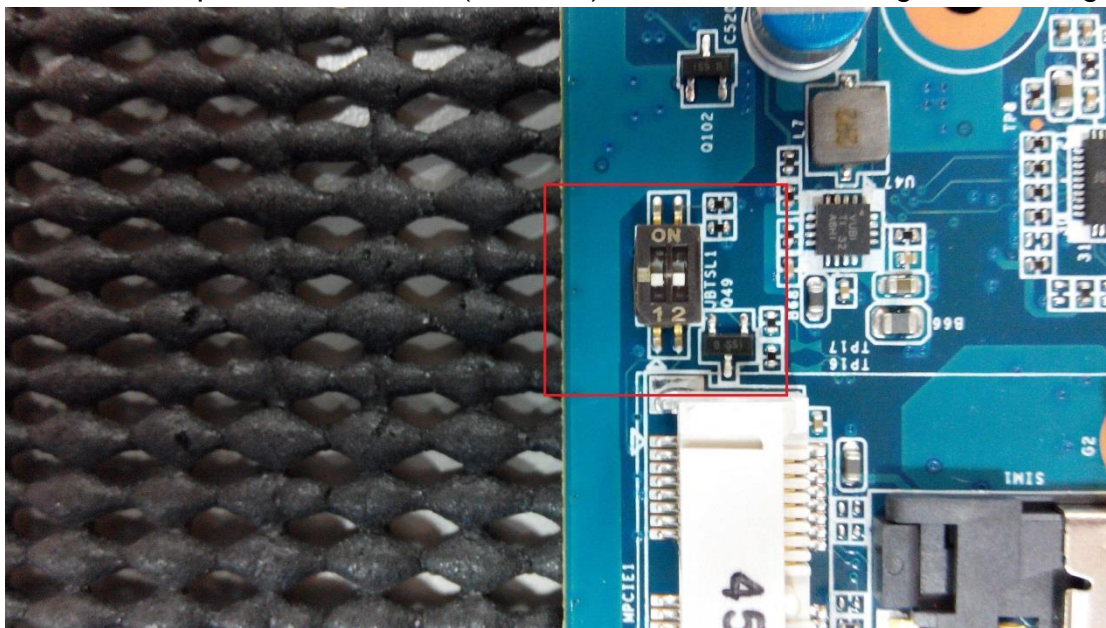

- 2) Power on the mainboard then plug the cable from OTG socket to PC.
- 3) Please click “**MFG-Helper**” under the path “~\POS-Android-MfgTools\Mfg-POS\”

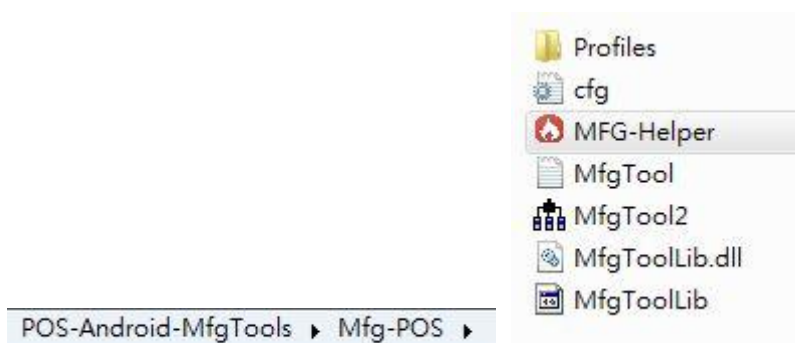

ACP-IMX6POS User's Manual

4) If the CPU of the mainboard is Quadcore version, please select as below, then click “Run MFG-Tools”.

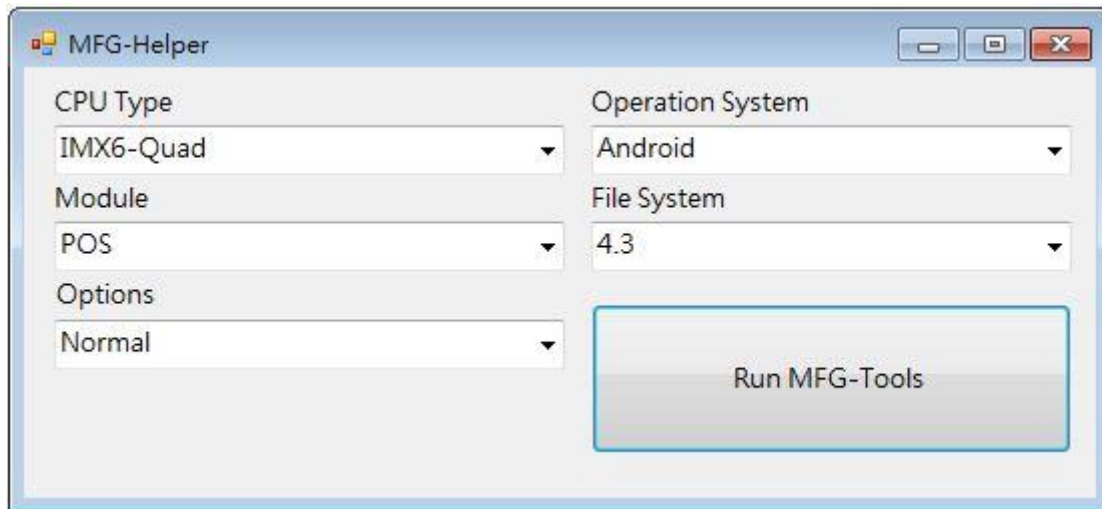

4-1) If the CPU of the mainboard is DualLite version, please select as below, then click “Run MFG-Tools”.

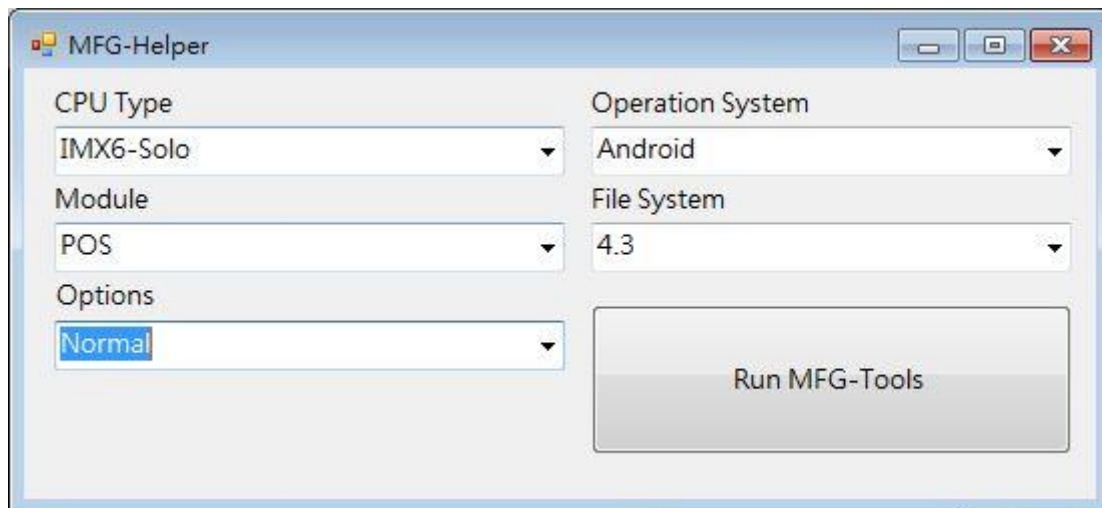

5) Click “Start” to flash image file.

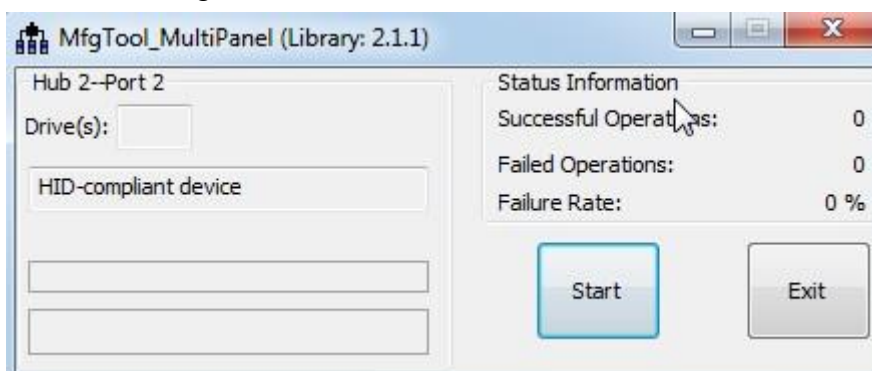

ACP-IMX6POS User's Manual

6) It will show "Done" after flashing is finish, then click "Stop" and "Exit" to close the screen.

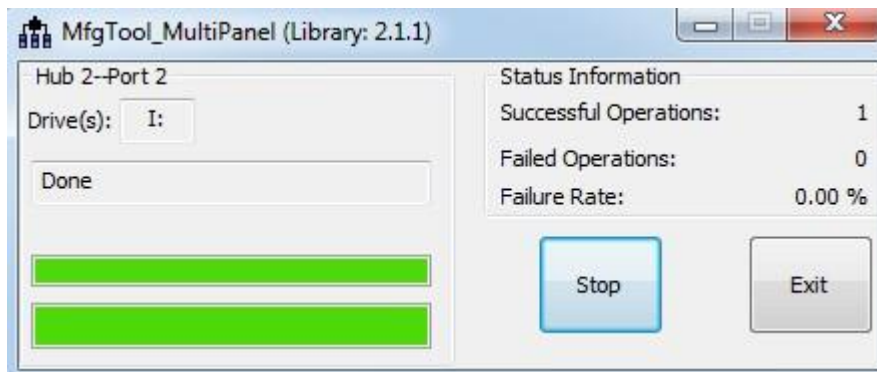

7) You can also get the information from Terminal (debug port→JUART1, baud rate set as 115200) after flashing is finish

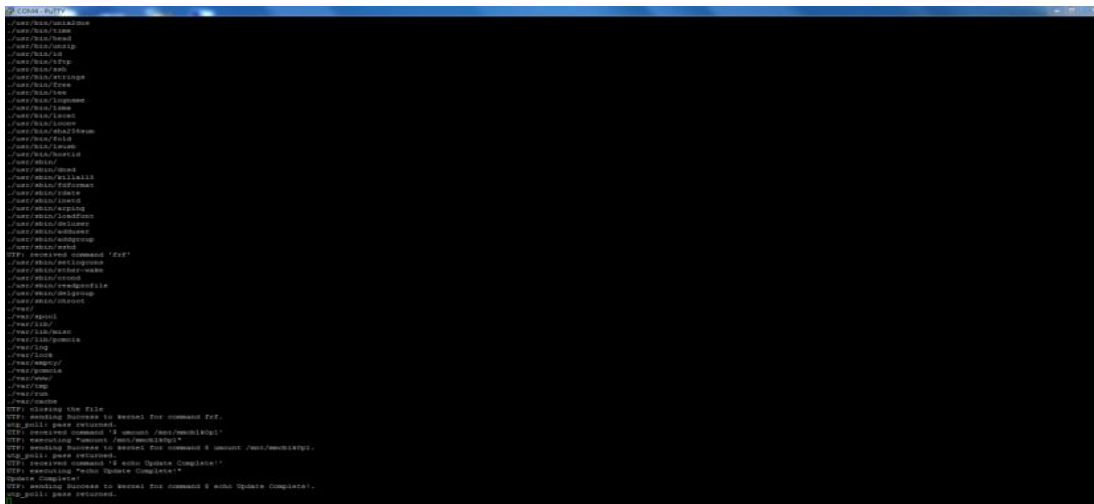

8) Power off the system and turn on pin1 of DIP switch then reboot.

