

# *LCD Module*

## *Product Specification*

: APPROVAL FOR SPECIFICATION

For Customer : \_\_\_\_\_  : APPROVAL FOR SAMPLE

Module No. :   TST043015CMHX  

For Customer's Acceptance :

Approved by	Comment

Team Source Display :

Presented by	Reviewed by	Organized by



This module uses ROHS material

---

# CONTENTS

1	General Descriptions
2	Mechanical Description
3	Mechanical Drawing
4	Interface Definition
5	Interface Timing
6	Absolute Maximum Ratings
7	DC Characteristics
8	Backlight
9	Optical Specification
10	Touch Panel
11	Reliability testing
12	Inspection Standard
13	Precaution

## Record of Revision

Rev	Issued Date	Description	Editor
1.0	2013-02-27	Preliminary Release	LiWEI

## 1. General Description

### 1.1 Introduction

Team Source Display-TST043015CMHX-P is a color active matrix thin film Transistor (TFT) liquid crystal display (LCD) that uses amorphous silicon TFT as a switching device. This model is composed of a TFT LCD panel, a driving circuit and a back light system. This TFT LCD has a 4.3 (16:9) inch diagonally measured active display area with WQVGA (480 horizontal by 272 vertical pixel) resolution.

### 1.2 Applications

- Personal Navigation Device
- Multimedia applications and Others AV system

## 2. Features

Display Mode	Transmissive, Normally white	
	4.3 (16:9 diagonal) inch configuration a-Si TFT	
Display Format	Graphic 480RGB*272 Dot-matrix	
Input Data	RGB interface 30 pins	
Viewing Direction	6 : 00 O'CLOCK	
Driver	HX8257A	
LCD Power Supply	3.3V for TFT Circuit	
Compliance	RoHS and Halogen-Free compliance	
Surface Treatment	Anti-Glare	
Item	Specifications	Unit
Dimensional outline	105.5(W)*67.2(H)*4.05(D)	mm
Resolution	480RGB*272	dots
LCD Active area	95.04(W)*53.856(H)	mm
Pixel size	0.198(W)*0.198(H)	mm





## 4. Interface Definition

PIN NO.	PIN Name	Funtion Description
1	VLED-	back light power supply negative
2	VLED+	back light power supply positive
3	GND	Ground
4	VDD	Power supply
5-12	R0-R7	Red Data
13-20	G0-G7	Green Data
21-28	B0-B7	Blue Data
29	GND	Ground
30	CLK	Colock signal
31	DISP	Display on/off
32	HSYNC	Horizontal sync input in RGB mode(short to GND if not used)
33	VSYNC	Vertical sync input in RGB mode(short to GND if not used)
34	DE	Data enable
35	NC	No Connection
36	GND	Ground
37	XR	touch panel X-right
38	YD	touch panel Y-bottom
39	XL	touch panel X-left
40	YU	touch panel Y-up

## 5. Interface Timing:

### 5.1 Reset Timing

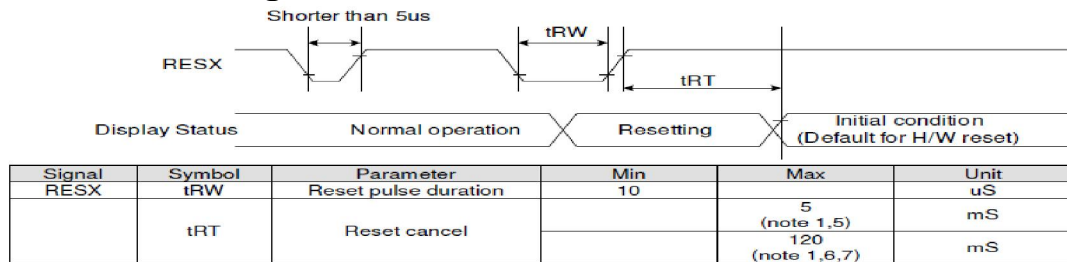

### 5.2 RGB Interface Timing

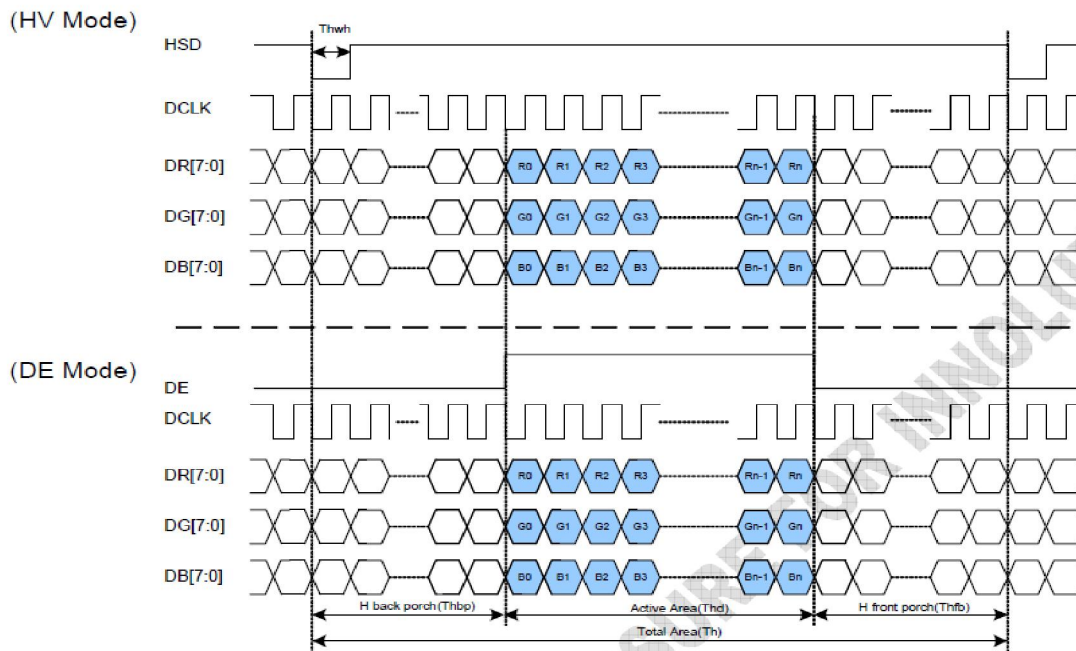

Parallel RGB input timign table

Parameter	Symbol	Value			Unit
		Min.	Typ.	Max.	
DCLK frequency	fclk	5	9	12	MHz
VSD period time	Tv	277	288	400	H
VSD display area	Tvd	272			H
VSD back porch	Tvb	3	8	31	H
VSD front porch	Tvfp	2	8	97	H
HSD period time	Th	520	525	800	DCLK
HSD display area	Thd	480			DCLK
HSD back porch	Thbp	36	40	255	DCLK
HSD front porch	Thfp	4	5	65	DCLK

### 5.3 AC Timing Diagram

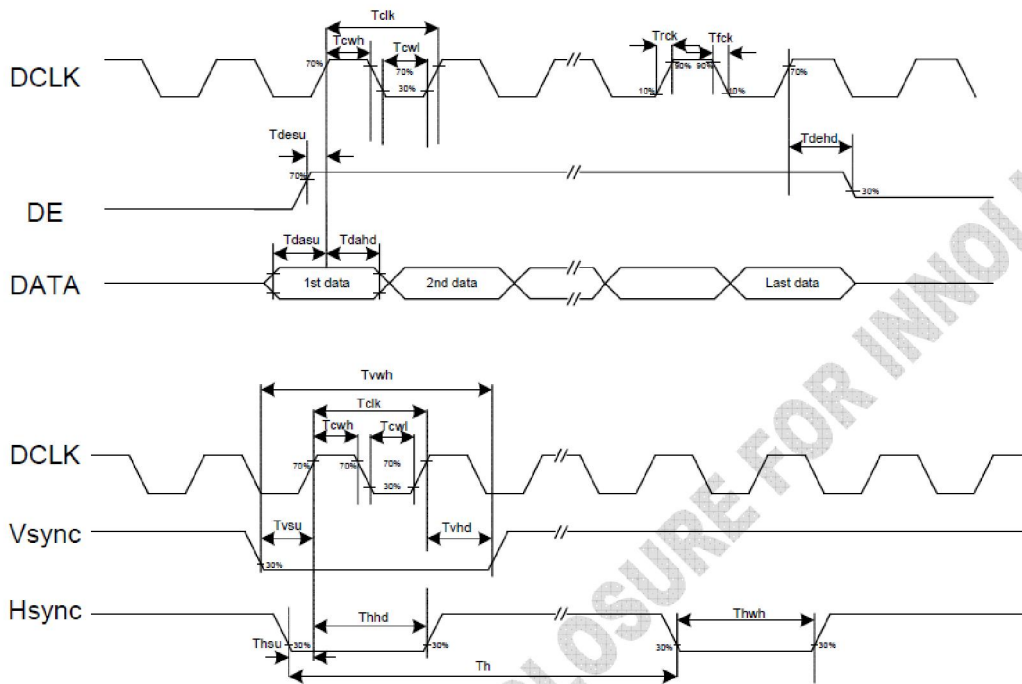

DCLK clock time	Tclk	33.3	-	-	ns	DCLK=30MHz
DCLK clock low period	Tcwl	40	-	60	%	
DCLK clock high period	Tcwh	40	-	60	%	
Clock rising time	Trck	9	-	-	ns	
Clock falling time	Tfck	9	-	-	ns	
HSD width	Thwh	1	-	-	DCLK	
HSD period time	Th	55	60	65	us	
HSD setup time	Thsu	12	-	-	ns	
HSD hold time	Thhd	12	-	-	ns	
VSD width	Tvwh	1	-	-	Th	
VSD setup time	Tvsu	12	-	-	ns	
VSD hold time	Tvhd	12	-	-	ns	
Data setup time	Tdasu	12	-	-	ns	
Data hold time	Tdahd	12	-	-	ns	
DE setup time	Tdesu	12	-	-	ns	
DE hold time	Tdehd	12	-	-	ns	
Source output setting time	Tsst	-	-	TBD	us	10% to 90% CL=60pF, RL=2Kohm
Gate output setting time	Tgst	-	-	TBD	ns	10% to 90%, CL=60pF
VCOM output setting time	Tcst	-	-	TBD	us	10% to 90%, CL=40nF, RL=50ohm
Time from VSD to 1st line data input	Tvs	3	8	31	Th	HV mode By HDL[4:0] setting



## 6. Absolute Maximum Ratings:

Name	symbol	Min	Type	Max	Unit
Operation Temperature	TOP	-20	-	70	°C
Storage Temperature	Tst	-30	-	80	°C

## 7. DC Characteristics

Name	Symbol	Min	Type	Max	Unit
Logical Voltage	VDD	3.1	3.3	3.5	V
Input High Voltage	V <sub>IH</sub>	0.8IOVCC	-	IOVCC	V
Input Low Voltage	V <sub>IL</sub>	-0.3	-	0.2IOVCC	V
Output High Voltage	V <sub>OH</sub>	0.8IOVCC	-	-	V
Output Low Voltage	V <sub>OL</sub>	-	-	0.2IOVCC	V
Current Consumption	IDD	-	-	25	mA

## 8. Backlight:

Name	Min	Type	Max	Unit
Current	-	40	45	mA
Voltage	-	15.6	17.1	V
Power Consumption	-	624	-	mW
luminance	-	500	-	CD/M <sup>2</sup> (Note1)
Luminance uniformity	75%	80%	-	(Note2)
X Color Coordinates	0.27	0.28	0.31	-
Y Color Coordinates	0.27	0.28	0.31	-
Backlight Lifetime	20000	30000	---	Hours

Note1: This luminance is tested with assembling the LCD.

Note2: Definition of Luminance Uniformity.

Active area is divided into 9 measuring areas (Refer to Fig. 4-4 ).Every measuring point is placed at the center of each measuring area.

$$Luminance\ Uniformity\ (Yu) = \frac{B_{min}}{B_{max}}$$

L-----Active area length    W----- Active area width

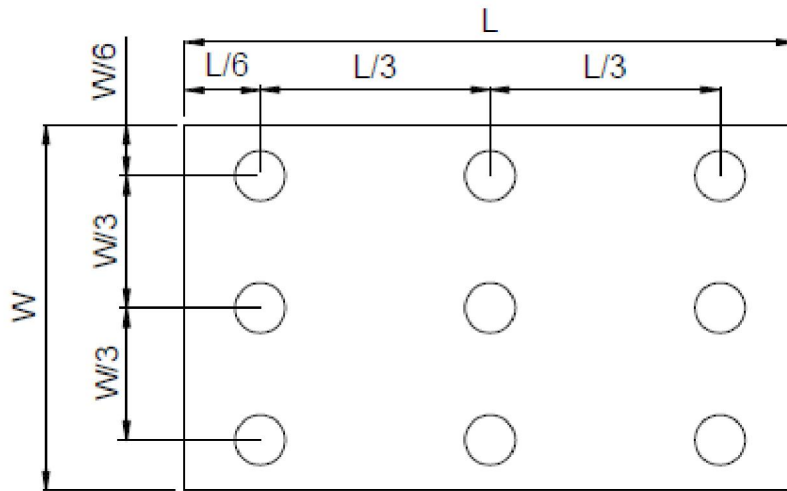

Fig. 4-4 Definition of measuring points

**B<sub>max</sub>**: The measured maximum luminance of all measurement position.

**B<sub>min</sub>**: The measured minimum luminance of all measurement position.

### 9. Optical Specification

Name	Symbol	Min	Type	Max	Unit
Transmittance rate	T (%)	-	4.6	-	%
Contrast ratio	C/R	400	500	-	-
Response time	Tr+Tf	-	45	-	ms
Viewing Angle	θ U	40	50	-	degree (C/R>10)
	θ D	60	70	-	
	θ L	60	70	-	
	θ R	60	70	-	

\*Viewing angle descriptin:

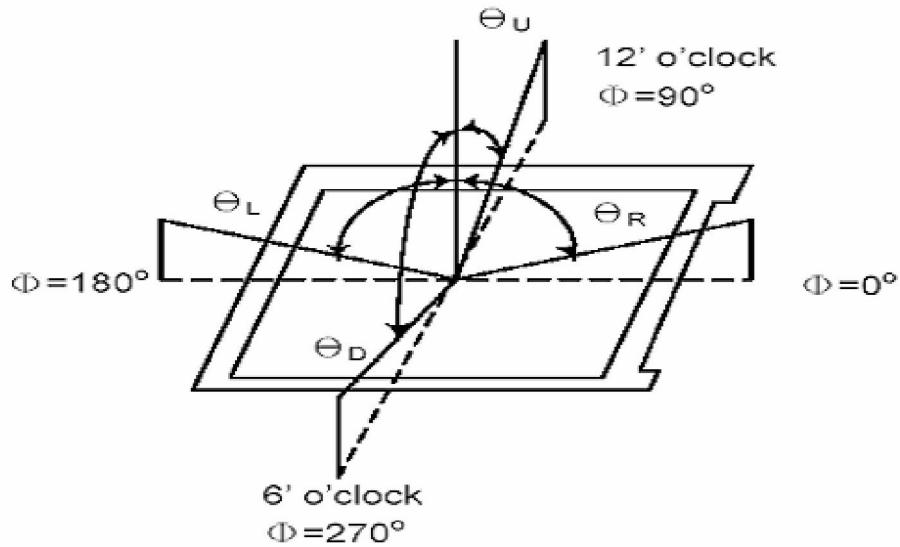

\*Contrast rate description(CR) :  
 Tested in the center of the LCM panel

$$CR = \frac{\text{Luminance with all pixels white}}{\text{Luminance with all pixels black}}$$

\*Response time description : Sum of TR and TF

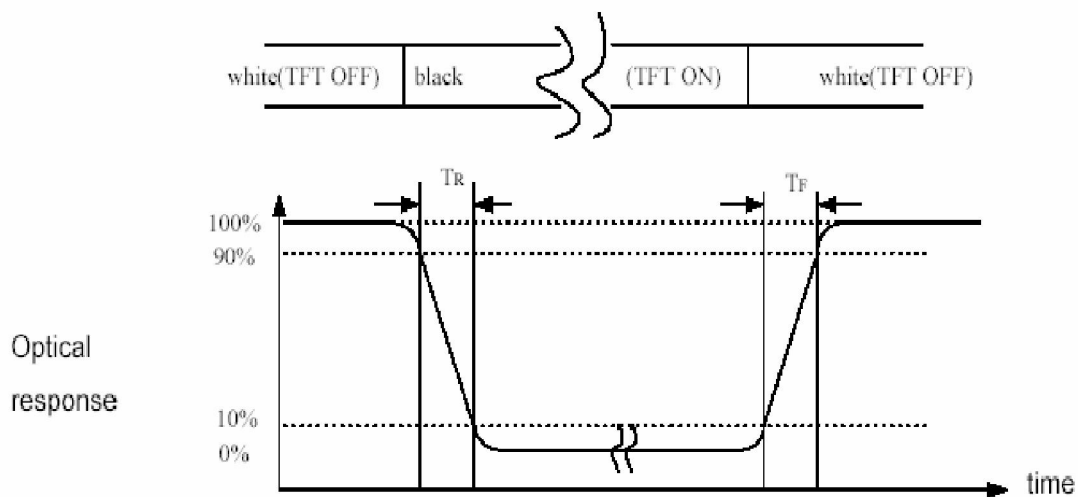

**10.Touch Panel:**

Item	Description	Unit
linearity	<1.5%	-
transmittance	>80%	-
Response time	<10	ms
Life time	1,000,000	times
Operation pressure	60~100	g
Circuit level	3~15	V

## 11. Reliability testing:

Item No	Name	Condition	Remark
1	High temperature Operating	70° C , 168Hours	Finish product (With polarizer)
2	Low temperature Operating	-20° C , 168 Hours	Finish product (With polarizer)
3	High temperature Storage	80° C , 168 Hours	Finish product (With polarizer)
4	Low temperature Storage	-30° C , 168 Hours	Finish product (With polarizer)
5	High temperature & humidity Storage	60° C , 90%RH, 168 Hours	Finish product (With polarizer)
6	Thermal Shock Storage (No operation)	-20° C , 30min. <=> 70° C , 30min. 10 Cycles	Finish product (With polarizer)
7	ESD test	Voltage:+8KV R:330 ohm, C:150pF Air discharge, 10 times	Finish product (With polarizer)
8	Vibration test	10 => 55 =>10 => 55 => 10 Hz, within 1 minute;Amplitude:1.5mm. 15 minutes for each Direction ( X, Y, Z )	Finish product (With polarizer)
9	Drop test	Packed, 100CM free fall 6 sides, 1 corner, 3edges	Finish product (With polarizer)

\*One single product test for only one item.

\* Judgment after test: keep in room temperature for more than 2 hours.

- Current consumption < 2 times of initial value
- Contrast > 1/2 initial value
- Function: work normally

# Inspection Standards

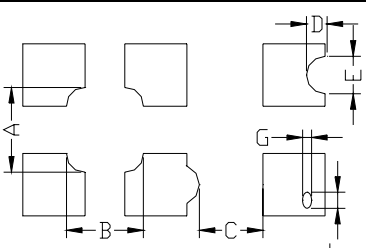
Item	Criterion for defects	Defect type
1) Display on inspection	(1) Non display (2) Vertical line is deficient (3) Horizontal line is deficient (4) Cross line is deficient	Major
2) Black / White spot	Size $\Phi$ (mm) $\Phi \leq 0.3$ Acceptable number $0.3 < \Phi \leq 0.45$ Ignore (note) $0.45 < \Phi \leq 0.6$ 3 $0.6 < \Phi$ 1 0	Minor
3) Black / White line	Length (mm) Width (mm) Acceptable number $L \leq 10$ $W \leq 0.03$ Ignore $5.0 \leq L \leq 10$ $0.03 < W \leq 0.04$ 3 $5.0 \leq L \leq 10$ $0.04 < W \leq 0.05$ 2 $1.0 \leq L \leq 10$ $0.05 < W \leq 0.06$ 2 $1.0 \leq L \leq 10$ $0.06 < W \leq 0.08$ 1 $L \leq 10$ $0.08 < W$ follows 2) point defect Defects separate with each other at an interval of more than 20mm	Minor
4) Display pattern	 $\frac{A+B \leq 0.28}{2} \quad 0 < C \quad \frac{D+E \leq 0.25}{2} \quad \frac{F+G \leq 0.25}{2}$ <p>Note: 1) Up to 3 damages acceptable 2) Not allowed if there are two or more pinholes every three-fourth inch.</p>	Minor
5) Spot-like contrast irregularity	Size $\Phi$ (mm) Acceptable Number $\Phi \leq 0.7$ Ignore (note) $0.7 < \Phi \leq 1.0$ 3 $1.0 < \Phi \leq 1.5$ 1 $1.5 < \Phi$ 0 Note: 1) Conformed to limit samples. 2) Intervals of defects are more than 30mm.	Minor
6) Bubbles in polarizer	Size $\Phi$ (mm) Acceptable Number $\Phi \leq 0.4$ Ignore (note) $0.4 < \Phi \leq 0.65$ 2 $0.65 < \Phi \leq 1.2$ 1 $1.2 < \Phi$ 0	Minor
7) Scratches and dent on the polarizer	Scratches and dent on the polarizer shall be in the accordance with "2) Black/white spot", and "3) Black/White line".	Minor
8) Stains on the surface of LCD panel	Stains which cannot be removed even when wiped lightly with a soft cloth or similar cleaning.	Minor
9) Rainbow color	No rainbow color is allowed in the optimum contrast on state within the active area.	Minor
10) Viewing area encroachment	Polarizer edge or line is visible in the opening viewing area due to polarizer shortness or sealing line.	Minor
11) Bezel appearance	Rust and deep damages that are visible in the bezel are rejected.	Minor
12) Defect of land surface contact	Evident crevices that are visible are rejected.	Minor
13) Parts mounting	(1) Failure to mount parts (2) Parts not in the specifications are mounted (3) For example: Polarity is reversed, HSC or TCP falls off.	Minor
14) Part alignment	(1) LSI, IC lead width is more than 50% beyond pad outline. (2) More than 50% of LSI, IC leads is off the pad outline.	Minor
15) Conductive foreign matter (solder ball, solder hips)	(1) $0.45 < \Phi$ , $N \geq 1$ (2) $0.3 < \Phi \leq 0.45$ , $N \geq 1$ , $\Phi$ : Average diameter of solder ball (unit: mm) (3) $0.5 < L$ , $N \geq 1$ , $L$ : Average length of solder chip (unit: mm)	Minor
16) Bezel flaw	Bezel claw missing or not bent	Minor
17) Indication on name plate (sampling indication label)	(1) Failure to stamp or label error, or not legible.(all acceptable if legible) (2) The separation is more than 1/3 for indication discoloration, in which the characters can be checked.	Minor

# Handling Precautions

## Mounting method

A panel of LCD module made by our company consists of two thin glass plates with polarizers that easily get damaged. When doing the mounting of the LCD module, extreme care should be used when handling the LCD modules.

## Cautions of LCD handling and cleaning

When cleaning the display surface, use soft cloth with solvent (recommended below) and wipe lightly.

- Isopropyl alcohol
- Ethyl alcohol
- Trichlorotrifluoroethane

Do not wipe the display surface with dry or hard materials that will damage the polarizer surface.

Do not use the following solvent:

- Water
- Ketene
- Aromatics

## Caution against static charge

The LCD module use C-MOS LSI drivers. So we recommend you:

Connect any unused input terminal to  $V_{dd}$  or  $V_{ss}$ . Do not input any signals before power is turned on, and ground your body, work/assembly areas, assembly equipment to protect against static electricity.

## Packaging

- Module employs LCD elements, and must be treated as such. Avoid intense shock and falls from a height.
- To prevent modules from degradation, do not operate or store them exposed direct to sunshine or high temperature/humidity.

## Caution for operation

-It is an indispensable condition to drive LCD module within the limits of the specified voltage since the higher voltage over the limits may cause the shorter life of LCD module.

- An electrochemical reaction due to DC (direct current) causes LCD undesirable deterioration so that the uses of DC (direct current) drive should be avoided.

-Response time will be extremely delayed at lower temperature than the operating temperature range and on the other hand at higher temperature LCD module may show dark color in them. However those phenomena do not mean malfunction or out of order of LCD module, which will come back in the specified operating temperature.

## Storage

In the case of storing for a long period of time, the following ways are recommended:

- Storage in polyethylene bag with the opening sealed so as not to enter fresh air outside in it. And with not desiccant.
- Placing in a dark place where neither exposure to direct sunlight nor light is. Keeping the storage temperature range.
- Storing with no touch on polarizer surface by any thing else.

## Safety

-It is recommendable to crash damaged or unnecessary LCD into pieces and to wash off liquid crystal by either of solvents such as acetone and ethanol, which should be burned up later.

-When any liquid leaked out of a damaged glass cell comes in contact with your hands, please wash it off well at once with soap and water.