

## CBIRF-ME250

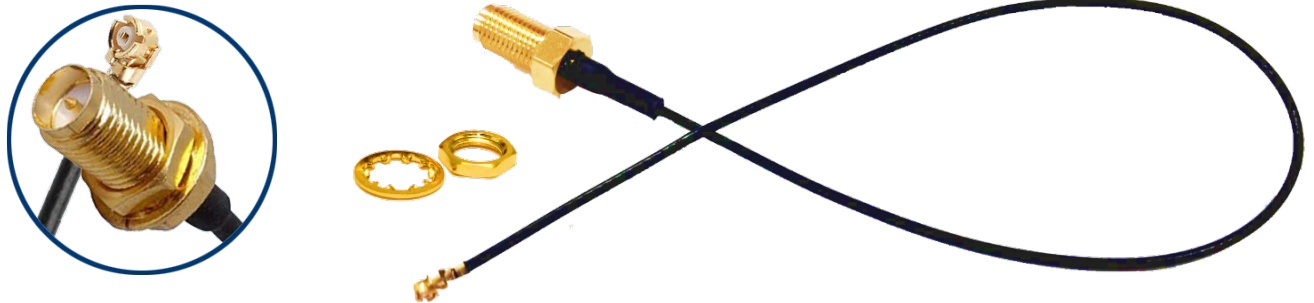

Provides Good Working Performance in Various Application of Wireless

This RP-SMA Cable is commonly used for WLAN radio modules which require the U.FL or IPEX connector.

You can connect the RP-SMSA Cable to WIFI module for transmitting and receiving signals also used to connect high-frequency module, ex. Router, PCI card, WIFI module.

RP-SMA Cable is compliant for all types of wireless antennas and have a reliable characteristic with long life-span, performance is excellent, high frequency.

### Specification

Connector	RP-SMA Female (Jack) MHF1
Connector Material	Gold Plated
Cable Type	Coaxial 1.37mm Black Jacket
Cable Length	250mm±3
Jacket Material	FEP
Jacket Color	Black

## Drawing Cable

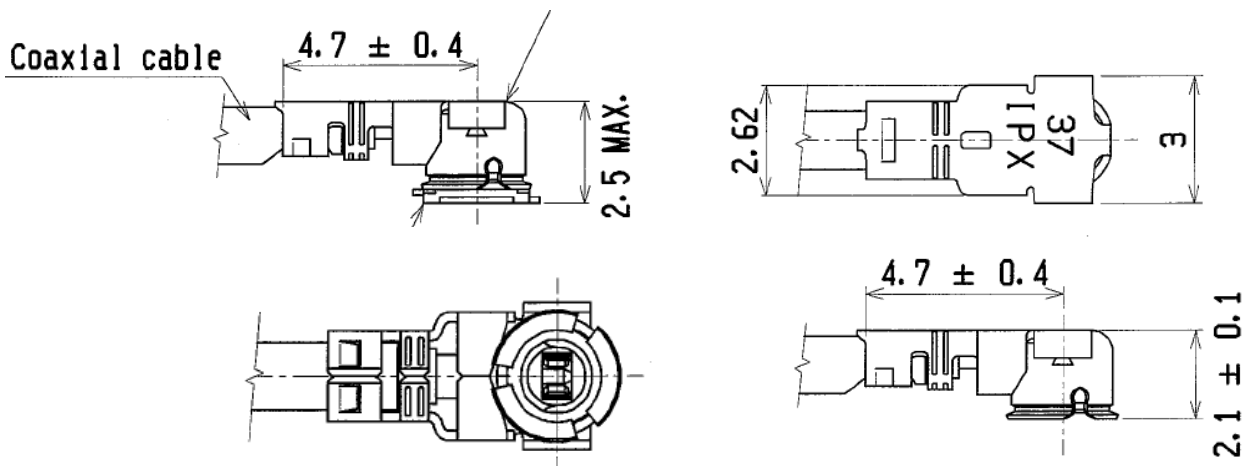
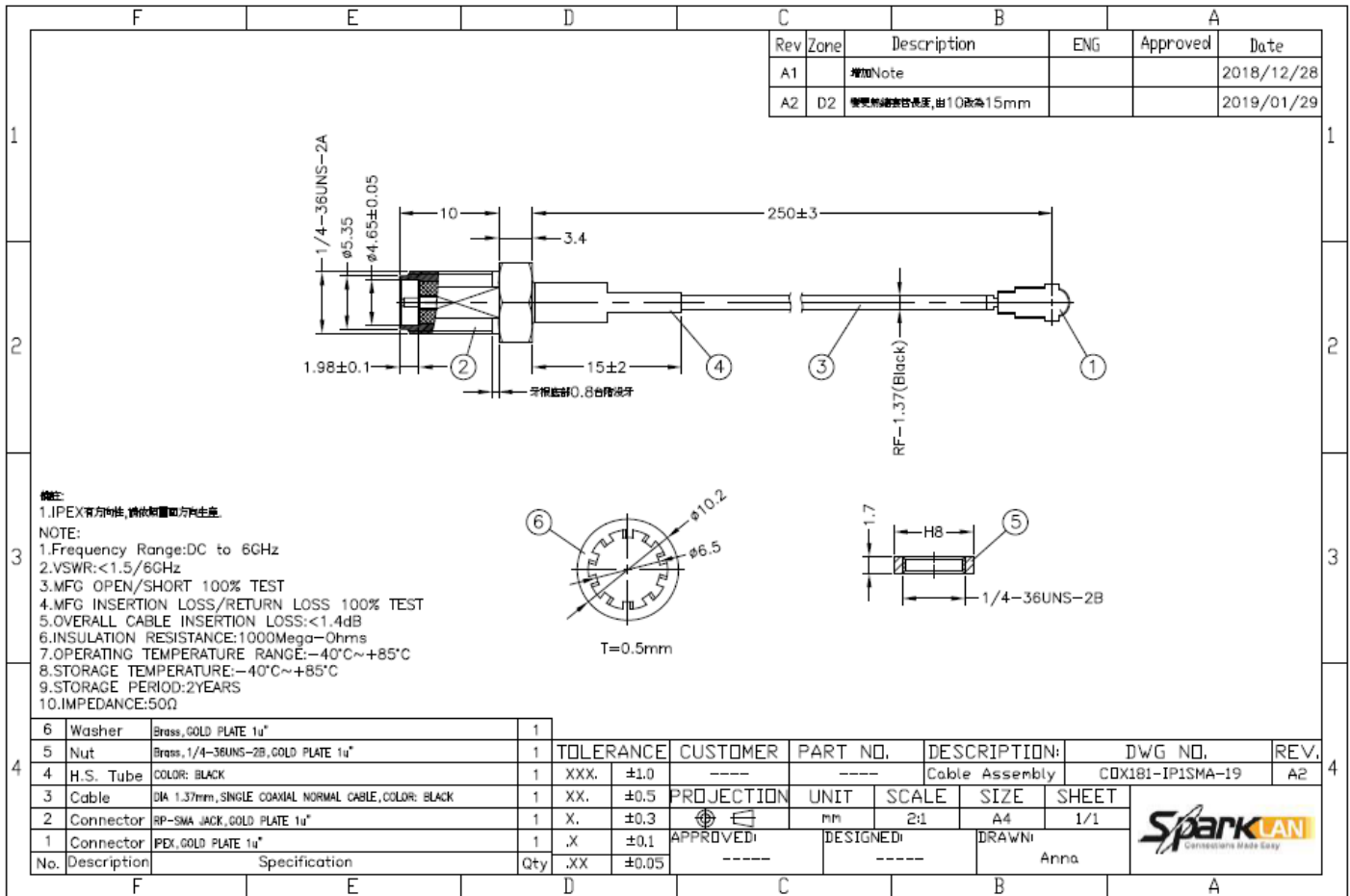

## Ordering Information

Model Name	Part Number	Description
CBIRF-ME250	R3470300024	RF Cable, I-PEX/MHF1 to RP-SMA(F); L:250mm; Coaxial 1.37 Black