



Product Guide: PRDRFM008B/PRDACC008C

Version 1.1
October 1, 2017

Presented by:
Klaus Seiberts
Jim Childers

Protagd reserves the right to make changes to its products or services or to discontinue any product or service at any time without notice. Protagd provides customer assistance in various technical areas, but does not have full access to data concerning the use and applications of customers' products.

Therefore, Protagd assumes no liability and is not responsible for customer applications or product or software design or performance relating to systems or applications incorporating Protagd products. In addition, Protagd assumes no liability and is not responsible for infringement of patents and/or any other intellectual or industrial property rights of third parties, which may result from assistance provided by Protagd.

Protagd products are not designed, intended, authorized or warranted to be suitable for life support applications or any other life critical applications which could involve potential risk of death, personal injury, or severe property or environmental damage.

Copyright © 2017 Protagd LLC

Table of Contents

1	Introduction	4
2	Abbreviations	6
3	Conventions	7
4	Product Description	8
4.1	General	8
4.2	RFM Transmitter	8
4.3	RFM Receiver	9
4.4	RFM Connections and Jumpers	9
4.5	ATB General	14
4.6	ATB Connections and Jumpers	14
5	Installation	15
5.1	Antenna	15
5.1.1	Connection	15
5.1.2	Requirements	15
5.1.3	Antenna Resonance	16
5.1.4	Remote Tuning Sender (RTS)	18
5.1.5	Tuning Procedure	18
5.2	Power Supply	19
5.2.1	Requirements	20
5.2.2	Connection	21
5.3	More Tuning	22
5.3.1	RXSS	22
5.3.2	Other jumpers	24
6	Characteristics	26
6.1	Mechanical Dimensions PRDRFM008B	26
6.2	Mechanical Dimensions PRDACC008C	26
6.3	Temperature Range	27
6.4	Recommended Operating Conditions – Electrical Characteristics	27
7	Regulatory Notes	31
7.1	Europe	31
7.2	USA	31
8	Appendix	32

8.1	Field Strength Adjustment.....	32
8.2	Adjustment of Oscillator Signal Pulse Width	33
8.3	Transmitter Carrier Phase Synchronization.....	35
8.4	Noise Considerations	37

1 Introduction

The **PRDRFM008B** and the **PRDACC008C** from Protagd offer an alternative to the corresponding Radio modules from Texas Instruments.

PRDRFM008B: High Performance Remote Frequency Module (RFM)

PRDACC008C: Antenna Tuning Board (ATB)

They are 100% drop-in compatible and deliver the same functions and performance:

- Same mounting hole patterns and size
- 7 – 24V supply
- 134.2KHz charge burst frequency
- 123.2KHz / 134.2KHz FSK reception frequency
- Same controller card connectors
- 6-toggle switch tuning box can be used for tuning
- Works with either RI-ACC-ATI2 or Protagd's RTS tuning indicator
- Same option jumpers are available

There are, however, some notable additional features for the PRDACC008C:

- Wider tuning range: 16.5 μ H to over 120 μ H in 1024 steps (10 jumpers)
- Better binary-weighted tuning with 75pF steps
- A Remote Tuning Annunciator (RTA) is built-in to the PRDACC008C to assist in tuning when used with the Remote Tuning Sender (RTS) from Protagd

For most applications, the PRDRFM008B and PRDACC008C should be drop-in replacements to the RI-RFM-008B and RI-ACC-008B.



Figure 1.1 PRDRFM008B

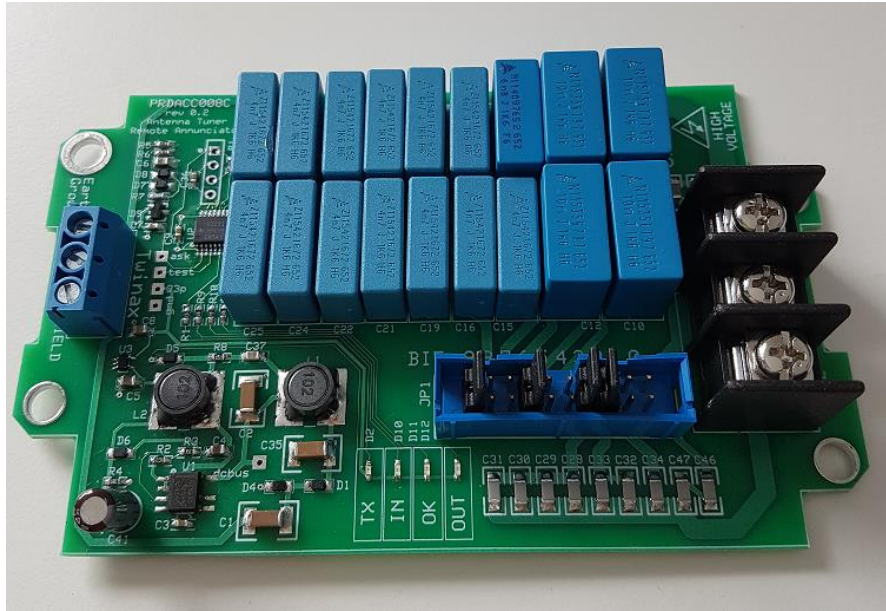

Figure 1.2 PRDACC008C

2 Abbreviations

ATB	Antenna Tuning Board
BCC	Block Check Character
COM	Communication (port)
CRC	Cyclic Redundancy Check
DC	Direct Current
EEPROM	Electrically Erasable Programmable Read-Only Memory
FW	Firmware
FSK	Frequency Shift Keying
HDX	Half Duplex
I/O	Input/Output
LED	Light Emitting Diode
LF	Low Frequency
N/A	Not Applicable
OOK	On-Off Keyed
PC	Personal Computer
PCB	Printed Circuit Board
PWE	Pulse Width Encoding
PWM	Pulse Width Modulator
Q	Quality Factor
RFID	Radio Frequency Identification
RFM	Radio Frequency Module
RFU	Reserved for Future Use
RO	ReadOnly
RS-232	Computer Serial Interface
RS-422/485	Computer Serial Interface
RW	ReadWrite
TI	Texas Instruments
UID	Unique Identification Number
USB	Universal Serial Bus

3 Conventions

Below conventions are used in this document to indicate vital information:



DANGER:

Care must be taken or a certain procedure must be followed to prevent injury or harm to your health.



CAUTION:

Information on conditions that must be met, or a procedure must be followed to prevent permanent damage.



Note:

Condition that must be met, or procedures must be followed to ensure proper functioning.

4 Product Description

4.1 General



Care must be taken when handling the RFM and ATB. High voltage across the antenna terminals and some parts of the PCB could be harmful to your health. Please ensure proper antenna insulation.



Handle the RFM and ATB according to ESD handling requirements. Do not touch any part without taking appropriate precautions. Do not hot-socket the modules. Power down before connecting or disconnecting any module, connector or cable.

The RFM, together with the associated ATB, represent an integral part of an RFID system. They allow the use of up to 120m of symmetrically shielded antenna cable (Twin-Ax) between an antenna and the Reader Unit.

4.2 RFM Transmitter

The transmitter power stage is supplied with power via two separate supply lines VSP and GNDP. Because of the high current requirements for the transmitter power stage, these supply lines are separated from the logic section supply lines and have two pins per line. The ground pins for the logic section and the transmitter are not connected internally to avoid potential problems with a high resistivity of GNDP pins and to increase flexibility when using long supply lines. Pins GND and GNDP must be connected to each other externally. For more details, refer to Section 5.2.

The transmitter power stage is internally connected to the supply lines GNDP and VSP via a common-mode choke coil to reduce electromagnetic interference (EMI) on the supply lines.

The regulated transmitter power stage supply may vary between +7 V and +24 V. The supply lines VSP and VSL should be connected when the supply voltage is +7 V or more. For details refer to Chapter 6.



Note: The RFM has a built-in temperature protection circuit, which sharply limits the transmitter power stage output if an over-current situation or an over-temperature environment causes the temperature to exceed the allowed limits. After the device is switched off and has time to recover (when the temperature drops again or the over-current situation is otherwise rectified) the unit reverts to normal operation when it is switched on again. Such an occurrence is an indication that the RFM is not being operated within specification.

The transmit frequency (134.2 kHz) from the oscillator is fed to the pulse width modulator (PWM). By changing the value of an external resistor, the PWM can set the pulse width ratio between 0% and 50%. For an example of two different oscillator signal pulse widths see Figure 4.1. Decreasing the 134.2 kHz frequency pulse width ratio (duty cycle) decreases the generated transmit (charge-up) field strength. It is therefore possible to adjust the generated field strength by selecting different pulse

width ratios. For more information about setting the field strength, refer to Section 8.2.

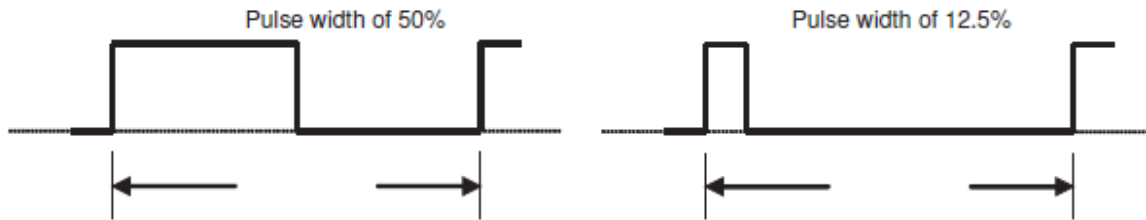

Figure 4.1 Pulse Width Examples



The RFM must not be operated in continuous transmit mode. When using pulse widths below 50%, the RFM transmitter power stage is less efficient. This leads to increased power dissipation and thus to a higher temperature.



Note: For an RFM physically located within the antenna field, it is necessary to shield the RFM.

4.3 RFM Receiver

The signal received from the transponder is a frequency shift keyed (FSK) signal with typical low and high bit frequencies of 134.2 kHz and 123.2 kHz, respectively. The signal is received from the antenna resonator, which is capacitively coupled to the receiver.

The signal RXCK is the reference clock to decode the RXDT data stream. The RXCK signal changes from low to high level during each data bit and the RXDT signal is valid before and after this positive slope for a certain time window. For more details refer to Table 6.3, Timing Characteristics.

The receiver also has a built-in RF received signal strength detector. The received signal strength is indicated by the digital output RXSS-. RXSS- becomes active (logic low level) when the received RF signal strength exceeds a defined level. This threshold level can be adjusted with a potentiometer (R60) on the RFM. The potentiometer is located near the variable inductors on the board. See Figure 4.3, RFM Top View. The RXSS- output is used for detection of other transmitting units and thus can be used for wireless synchronization.

4.4 RFM Connections and Jumpers

Figure 4.3 shows a top view of the PRDRFM008B without heatsink.

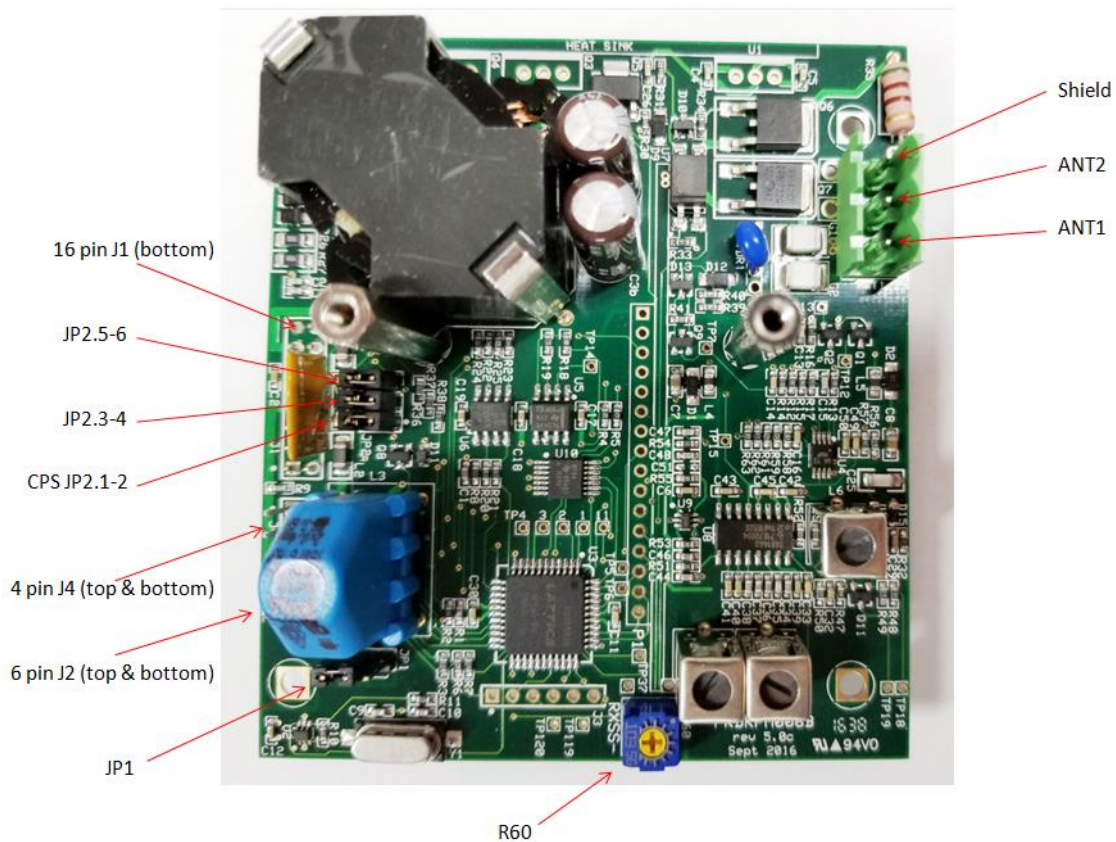

Figure 4.2 PRDRFM008B Top View

Several connectors, jumpers and other components are available on the RFM:

J1 - Connector for supply voltages and interface signal lines to and from the RFM

J2 - Connector for the (optional) Remote Tuning Sender (RTS) or AT12, which can be used for easy antenna tuning during installation. The resonance tuning is carried out with the Antenna Tuning Board near the antenna.

J4 - Connector for field strength adjustment resistor.

JP14 - Common-mode noise choke bypass.

R60 - RXSS noise level adjustment potentiometer.

JP2.1-2, 3-4, 5-6 - CPS; default: all jumpers inserted.

ANT1, ANT2, Shield - 3-pin antenna connector connects the RFM via a symmetrically shielded antenna cable (Twin-Ax) to the Antenna Tuning Board.

The RA-RFM is normally mounted from the underside utilizing appropriate spacers and four M3 mounting bolts. Connectors J2, J4, JP4, R60, CPS and the antenna terminals are accessible from the top.

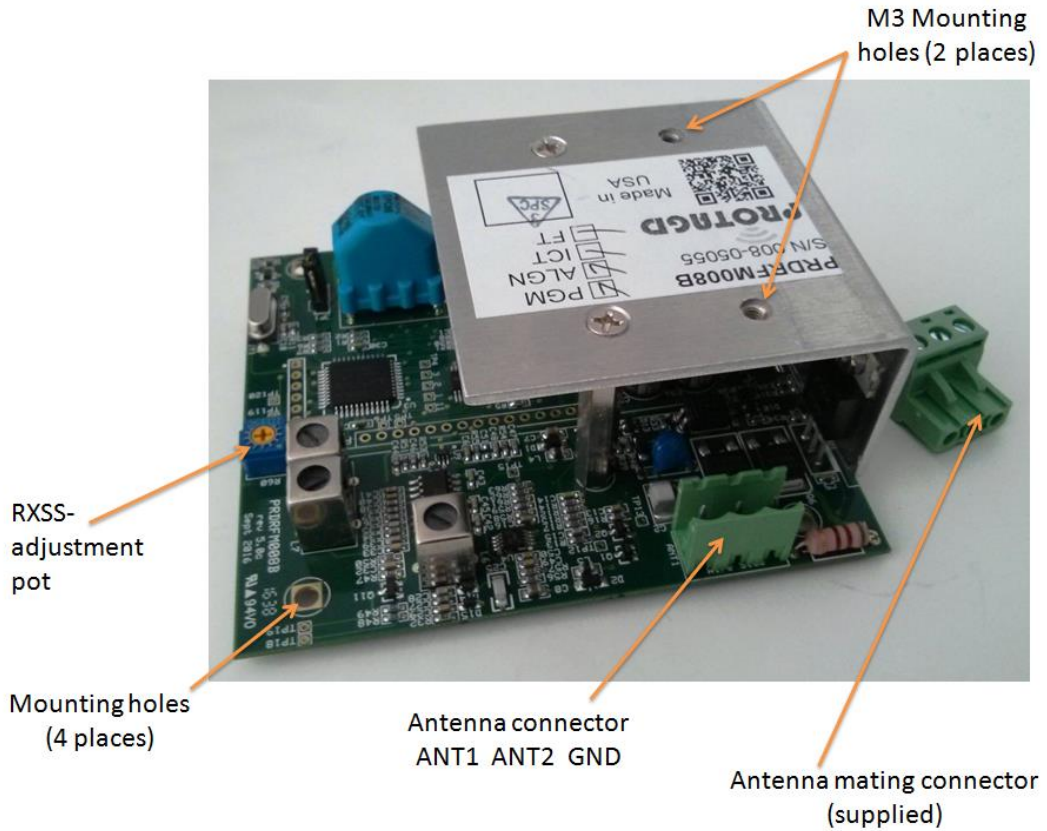

Figure 4.3 PRDRFM008B Picture

The bottom view of the RFM is shown in Figure 4.4. The connectors J1, J2, J3 and J4 are accessible from the underside. J1 is the 16-pin module connector, this carries the supply voltage lines, the data, and the control lines.

The RFM is normally mounted from the underside utilizing appropriate spacers (supplied with the PRDCTLMB2B and PRDCTLMB6B controller boards) and M3 mounting bolts.

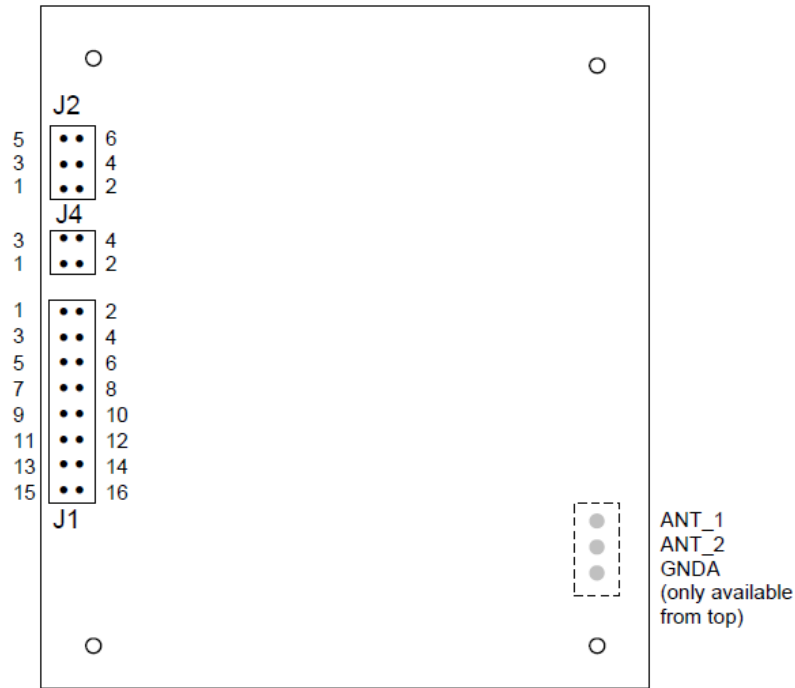

Figure 4.4 PRDRFM008B Bottom View

Table 4.1: J1 Pin Functions Table 4.1 lists the pin functions for connector J1. The connector type is 16-pin, 2-row with 2.54 mm pin spacing.

Pin#	Signal	Direction	Description
1	GND	IN	Logic ground
2	TXCT-	IN	Transmitter control input for activation of transmitter (active low, internal pull-up resistor)
3	VSL	IN	Supply voltage for logic and receiver
4	RXDT	OUT	Logic level compatible receiver data signal output
5	RXSA	IN/OUT	Receiver signal strength adjust for RXSS- threshold level
6	RXCK	OUT	Logic level compatible receiver clock output
7	GNDP	IN	Transmitter power stage ground
8			No connection
9	GNDP	IN	Transmitter power stage ground
10	RSTP	OUT	Analog receiver signal strength test pin
11	VSP	IN	Supply voltage for transmitter power stage
12	CPS_OUT	OUT	Carrier Phase Synchronization oscillator signal output
13	VSP	IN	Supply voltage for transmitter power stage
14	RXSS-	OUT	Receiver signal strength output (active low)
15			No connection
16	CPS_IN	IN	Carrier Phase Synchronization oscillator signal input

Table 4.1: J1 Pin Functions



The transmitter ground pins GNDP and logic ground pin GND must be connected externally. Otherwise the RFM may become permanently damaged.

Table 4.2 lists the pin functions for the ATI connector J2: The connector type is a 6-pin, 2-row connector with 2.54 mm pin spacing.

Pin #	Signal	Direction	Description
1	TXCT-R	IN	Transmitter control signal via resistor (active low)
2	GND	OUT	Logic ground
3	VD	OUT	Internal regulated logic supply voltage output
4	F_OSC-R	IN/OUT	Pulse width modulated transmitter oscillator signal via resistor
5	RXSS-	OUT	Receiver signal strength output (active low)
6	F_ANT	OUT	Antenna resonance frequency output signal (open collector)

Table 4.2: J2 Pin Functions

Table 4.3 lists the pin functions for the J4 pulse width adjustment connector. The connector type is 4-pin, 2-row with 2.54 mm pin spacing.

Pin#	Signal	Description
1	RX	Analog transponder signal
2	GNDA	Ground antenna circuit
3		Pulse width adjusting resistor connecting pin
4	GND	Logic ground

Table 4.3: J4 Pin Functions

Table 4.4 lists the pin functions for the antenna connectors used to connect the RFM to the ATB.

Pin#	Signal	Direction	Description
1	GNDA	OUT	Ground for cable shield
2	ANT_2	IN/OUT	Symmetrical antenna input/output 2
3	ANT_1	IN/OUT	Symmetrical antenna input/output 1

Table 4.4: Antenna Connectors

Jumper JP14 allows enabling and disabling of common noise filtering for EMI purposes. The default setting, with common noise filtering active, jumpers pins 2 and 3. A jumper between pins 1 and 2 bypasses common noise filtering.

Shorting Jumper JP2	Jumper	Description
1-2	IN (default)	Carrier Phase Sync
3-4	IN	RXCK
5-6	IN	RXDT

Table 4.5: Transmitter Carrier Phase Synchronization

4.5 ATB General

To achieve high resonance voltage and thus high charge-up field strength, the antenna circuit must be tuned to resonance. This is the purpose of the capacitor array on the ATB board.

The total resonance capacitance consists of the ATB capacitance plus the cable capacitance (ATB to RFM).

Each resonance capacitor can be switched in and out of the circuit by a single jumper to tune the RFM to resonance, i.e. match the RFM to different antenna inductances.



Care must be taken when handling the ATB. High voltage across the antenna terminals and some parts of the PCB could be harmful to your health. Please ensure a proper antenna insulation.

4.6 ATB Connections and Jumpers

Table 4.6 through **Table 1-8** show connector and jumper signals. Connector J2 on the ATB is for connecting the antenna.

Pin #	Signal	Direction	Description
1	ANT	To antenna	Symmetrical antenna signal
2			No connection
3	ANT	To antenna	Symmetrical antenna signal

Table 4.6: Antenna Connector J2

Connector J1 on the ATB is for connecting the cable running from the RFM to the ATB. Similar to the RFM antenna connection, there are three terminals on J1 for connecting a symmetrical pair of twisted cable and their shield wire.

Pin #	Signal	Direction	Description
1	RFM1	To RFM ANT1	Symmetrical cable signal
2	RFM2	To RFM ANT2	Symmetrical cable signal
3	SHIELD	To RFM SHIELD	Shield connection

Table 4.7: Antenna Cable Connector J1



One of the pre-drilled mounting holes is labeled 'Earth Ground'. This hole can optionally be used to ground the ATB to its housing; however, if the housing is grounded locally, do not connect the ATB ground as this can create a ground loop, thus, reducing the effectiveness of the cable shielding.

5 Installation

This chapter shows how to install the RFM and ATB, and specifies power supply requirements and connections.

5.1 Antenna

5.1.1 Connection



Care must be taken when handling the ATB. High voltage across the antenna terminals and some parts of the PCB could be harmful to your health. In addition, please ensure proper antenna insulation.

Terminals ANT1 and ANT2 of the RFM must be connected to the ATB via a twin lead cable, preferably with a shield (Twin-ax). The shield of the cable is connected to the terminal marked. If the twin lead cable is not shielded, then it must be a twisted pair. Unshielded cable is more susceptible to noise but can work in quiet environments.

If the distance from the RFM to the ATB is under 200m, it is **not** necessary to connect the RFM to the ATB with large cable or Litz wire. The impedance of the Twin-ax is of minor concern as the current from the RFM to the ATB is small (typically less than 75mA).

The antenna must be connected to ANT1 and ANT2. Please use some restraint when tightening the antenna screws. Support the PCB under the connector while tightening to avoid possibly cracking the PCB.

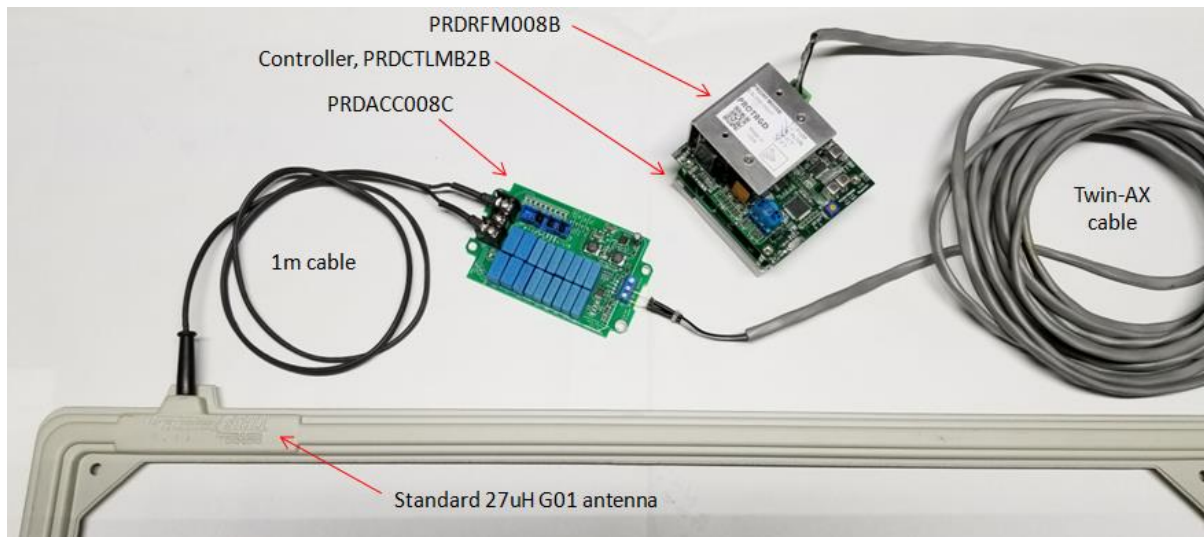

Figure 5.1 Connections

5.1.2 Requirements

To achieve high voltages at the antenna resonance circuit and thus high field strength at the antenna for the charge-up (transmit) function, the antenna coil must be high Q. The recommended Q factor for proper operation is listed in Table 5.1.

The Q factor of the antenna may vary depending on the type, the construction and the size of the antenna. Furthermore, this factor depends on the wire type and wire cross-sectional area used for winding of the antenna.

RF braided (or Litz) wire, consisting of several small single insulated wires is recommended for winding of an antenna since it gives the highest Q factor and thus the highest charge-up field strength, for example single wire diameter of 0.1 mm (4 mil) and 120 single insulated wires. The critical maximum diameter of an individual insuwire, which should be used for 134kHz is 0.36mm (0.014”) due to the skin effect.



If a high Q is not required, for example for large in-ground antennas, standard braided wire can be used.

To ensure that the transmitter and receiver function correctly, the antenna must be tuned to the resonance frequency of 134.2 kHz. For a detailed description of the antenna resonance tuning procedure, refer to 5.1.5.

To ensure that the antenna can be tuned to resonance with the RFM, the antenna inductance can only vary within the limits given in Table 5.1.

Parameter	Conditions	Min.	Max.	Unit
L_ANT	Antenna tuning range	16.5	120	μH
Q_ANT	Recommended Q factor	40	450	-

Table 5.1: Antenna Parameter



Although a ferrite core antenna may have a high Q factor under test conditions with low magnetic field strengths, the Q factor decreases when a high magnetic field strength is applied to the ferrite core.



The transformer of the transmitter power stage is operated at a high magnetic flux. Due to the high level of magnetic flux change, the transformer may emit an audible tone. This may also occur with antennas that have a ferrite core (e.g. PRDANTS02C). This tone does not indicate a malfunction.

5.1.3 Antenna Resonance

To achieve a high charge-up field strength, the antenna resonator frequency must be tuned to the transmitter frequency of 134.2 kHz. This is done by adjusting the capacitance of the ATB.

The tuning capacitors of the ATB are in a binary-weighted arrangement. The gold pin connector JP1 contains binary bits 9 through 0.

Bit #	nF
9	37.60
8	18.80
7	9.400
6	4.700
5	2.350
4	1.180
3	0.600
2	0.300

1	0.150
0	0.075

Table 5.2: Capacitor Values

The total capacitance provided by the ATB is 85.2nF. There is a built-in minimum capacitance of 10nF. For the mostly used LF antennas with an inductance of 27 μ F the required capacitance to achieve a 134.2kHz resonance is 52.1nF. Given that 10nF is built-in, the additional capacitance provided via jumpers needs to be 42.1nF. As such, the jumper combination would be as follows:

$$37.6\text{nF (bit 9)} + 2.35\text{nF (bit 5)} + 1.18\text{nF (bit 4)} + 0.6\text{nF (bit 3)} + 0.3\text{nF (bit 2)} + 0.075\text{nF (bit 0)} = 42.105\text{nF}$$

Given that all components such as the antenna, the circuit board and the capacitors have certain tolerances, the above capacitance/jumper combination is only nominal. In reality, it will vary at least for the lower capacitance values.

Monitoring of the correct antenna resonance tuning can be performed using the Remote Tuning Sender (RTS) from Protagd. The Antenna Tuning Indicator (ATI) tool RI-ACC-ATI2 from Texas Instruments will work likewise.

This device allows the transmitter to be operated in pulsed mode, independently of the Control Module. It indicates by red LEDs if the tuning capacitance should be increased or decreased (indicated as IN for increase capacitance and OUT for decrease). When the antenna is tuned to resonance, the green LED will be lit.

The following notes refer to antenna resonance tuning in general:



If an antenna must be installed in an environment where metal is present, the tuning of the antenna must be done in this environment, since the presence of metal changes the inductance of the antenna. In addition, the Q factor of the antenna decreases, thereby decreasing the field strength. The extent of the inductance and quality factor reduction depends on the kind of metal, the distance of the antenna from it, and its size.

When the oscillator signal pulse width, or the supply voltage (VSP) of an RFM with a pre-tuned ferrite core antenna (for example: PRDANTS02) is changed by a factor of more than 50%, the ferrite core antenna must be re-tuned to the new conditions due to the inductance changing slightly at different field strengths.

Each antenna is tuned individually to the RFM and this results in a unique tuning jumper arrangement for this combination of antenna and RFM.

If a different antenna or RFM is connected, the new combination must be tuned to resonance again. That is, it is not recommended to 'copy' the jumper pattern from one RFM/antenna pair to another as poor tuning will likely result.

5.1.4 Remote Tuning Sender (RTS)

Using the RTS makes tuning easy. The RTS tells you 'IN' (add capacitance), 'OUT' (remove capacitance), or 'OK' (you are done). The RTS plugs into J2 with the ribbon cable facing outward as shown in Figure 5.2 below.

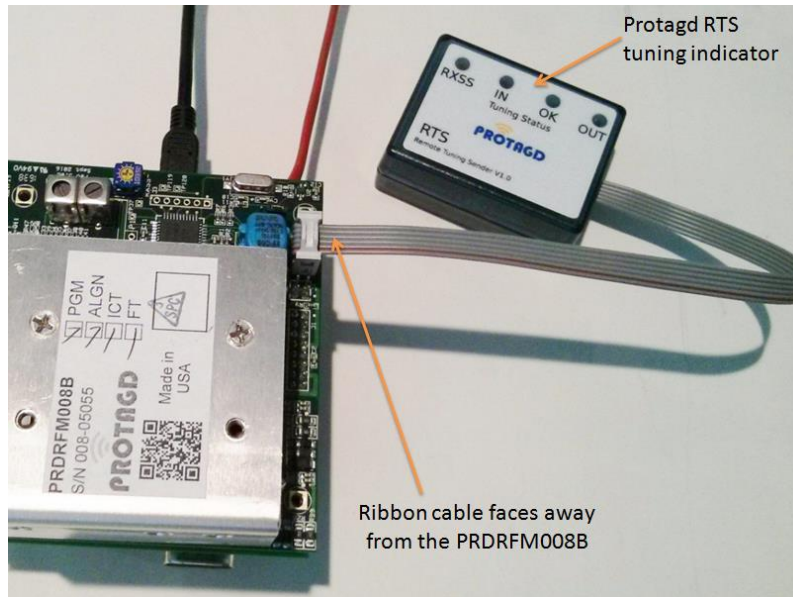

Figure 5.2 RTS Connection

5.1.5 Tuning Procedure

A total of 10 jumpers are supplied, market 9...0. Some are on the pins already and the rest are in a plastic bag accompanying the RFM.

The tuning is very easy. Each of the ten jumpers adds capacitance to the resonance circuit if its corresponding jumper is plugged in. The capacitors are binary weighted as shown in Table 5.2 above. Trimming is always done starting with the highest capacitance value corresponding to bit 9. Depending on the RTS indication the jumper remains plugged (IN) or is removed (OUT). Then the next biggest capacitance is selected (bit 8). Again, the RTS is used to decide if the jumper remains plugged or not. The procedure is continued until either the last capacitance is tried or the green LED (OK) is lit indicating that tuning is finished.



When using pliers to place and pull jumper shunts, it is essential to use pliers with insulated grips. Even after the power is off, it is possible that some of the capacitors have residual charge. Be certain to turn power off while moving jumpers.



The RI-ACC-008B has a very narrow tuning range from 26.0 to 27.9uH, while the PRDACC008C has a tuning range from 16.5 to 120uH. This broad tuning range is greater than the RTS or ATI2 can properly indicate. For this reason:

- if you are tuning an antenna with an inductance greater than 50 μ H, start the tuning process with all tuning jumpers removed.
- if you are tuning an antenna with an inductance less than approximately 50 μ H, start the tuning process with only jumper bit 9 plugged in.

Preparation:

- Turn off power.
- Remove all jumpers from JP1 (bits 9-0).
- Connect the RTS ribbon cable.
- Antennas with an inductance below 50 μ H (i.e. G01E, G02E TI antennas): Plug in the jumper for bit 9 (2nd left pair of pins on JP2). See note above.
- Power the system on and observe the RTS tuning indicator LEDs.

The tuning is now done in a loop as follows:

1. Observe the LEDs on RTS (Yellow RXSS LED may be lit or flickering. Just ignore it for now).
 - A. **Red** 'IN' LED is lit: Remove power; plug in next jumper (counting bit # down). Go back to 1.

OR

- B. **Red** 'OUT' LED is lit: Remove power; remove current jumper. Go back to 1.

OR

- C. **Green** 'OK' LED is lit: Tuning is finished.

- Turn off the power and unplug the RTS.

It can happen that the green LED 'OK' does not light at all, that is, jumper 0 switches the LEDs from IN to OUT. In this case the optimum capacitance is between two achievable values based on the capacitance array. However, as the smallest capacitance is only 0.075nF, the error is very small and will affect tuning imperceptibly. This happens when the Q (or quality factor) of the antenna is very high and the antenna is tuned to resonance. In this case, jumper 0 can be left in or removed.

Recommended Cable: Twin-ax

- Characteristic impedance: 100 to 105 Ohms
- Capacitance: 50.9 pF/meter
- Diameter: 8.4 mm

5.2 Power Supply

The RFM requires up to 24V of power, which is supplied from the user-supplied control board or any suitable interface board.



Caution if using the interface board with an MRD2: By default, the MRD2 at power-up causes the RFM's transmitter to send a constant carrier signal. This can harm the RFM if left on for an extended period. Please make sure to setup the MRD2 accordingly, i.e. set the "Power Reader (RFM) connected" flag to 'on'.

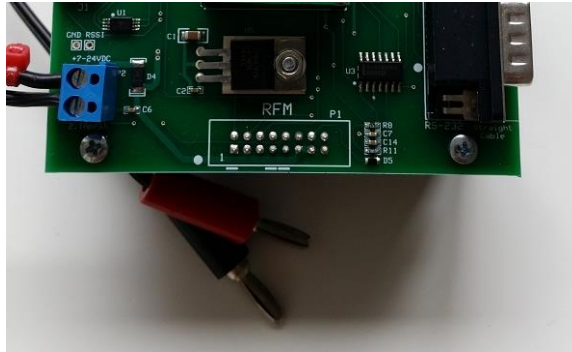

Figure 5.3 Power Supply Connected to PRDBIF1 Controller

5.2.1 Requirements

The logic and receiver sections of the RFM can be supplied via the VSL and GND pins with unregulated voltage.

The transmitter power stage is separately supplied via VSP and GNDP. As there is no stabilization circuitry on the RFM and as the transmitter power stage needs a regulated supply voltage to meet FCC/R&TTE regulations, the supply voltage for the transmitter power stage must be regulated externally. For the voltage supply range please refer to Chapter 6.



Note: The RFM should not be supplied by a switched-mode power supply (SMPS) as many SMPS operate at frequencies at or below 134kHz. The harmonics of the generated field may interfere with the RFM's sensitive receiver; therefore, only linear power supplies, or SMPS with a fundamental operating frequency of at least 200 kHz are recommended. PC supplies and laptop chargers are common sources of RFM read failure.

Noise from power supplies or from interface lines may interfere with receiver operation. It is recommended to add additional filters in series with the supply and interface lines if required by the application. For more details refer to Section 8.4.

To guarantee full RFM performance, the power supplies should fulfill the specifications for ripple voltage given in Table 5.3.

Supply Type	Maximum Ripple Voltage	Allowable Ripple Frequency
Unregulated VSL supply	30 mVrms	0 to 100 kHz maximum (sinusoidal)
Regulated VSP supply	50 mVrms	0 to 50 kHz maximum (sinusoidal)

Table 5.3: Ripple Specification

5.2.2 Connection

Ground pins for the logic/receiver part and the transmitter power stage are not directly connected internally; the two different grounds having to be connected to each other externally.

This is necessary for two reasons:

1. A high resistivity of the GNDP pins could cause a voltage drop across these pins, due to high transmitter power stage current (this does not apply to the supply pins of the logic section). If the grounds were connected to each other internally, this would also lift the internal logic ground and cause logic level compatibility problems with the Control Module (see Figure 5.4).
2. To provide greater flexibility when using long supply lines. Long VSP supply lines between the RFM and the Control Module cause a voltage drop across this supply line (again due to high-transmitter power stage supply current). This voltage drop would also lift the logic ground and cause logic level compatibility problems with the Control Module. This can be avoided by connecting the grounds externally in any of three different ways (see also Figure 5.4) as described below:

For cable lengths of up to 0.5 m between RFM and Control Module, the RFM ground pins GND and GNDP must be connected at the Control Module, as shown in Figure 5.4. The grounds for the VSP, VSL and the Control Module supply are connected at a common ground. Alternatively, if the voltage drop across the VSP supply line is less than 0.5 V (likely in this case), the ground pins GND and GNDP may be connected at the RFM. When using a customer-specific controller, care must be taken to connect the RFM ground pins GND and GNDP to an appropriate ground on the controller.

For cable lengths of between 0.5 m and 2 m, the RFM ground pins GND and GNDP must be connected at the Control Module to avoid logic level compatibility problems caused by the voltage drop across the VSP supply lines. Connecting the ground pins at the RFM is not permitted since this would lift the logic ground level.

Cable lengths longer than 2m are not recommended. If the application demands cabling longer than 2m, the logic signals between the RFM and the Control Module should be done via a differential interface (for example RS422). Due to different ground potentials at different locations it may also be necessary to provide galvanic separation of the interface signals by, for example, opto-couplers. In this case, to avoid problems with difference voltages between GND and GNDP, these pins must always be connected directly at the RFM. As shown in Figure 5.4, a shorting bridge is necessary for this purpose, situated as close as possible to the RFM.



The voltage between GND and GNDP must not exceed 0.5V, otherwise the RFM will suffer damage.

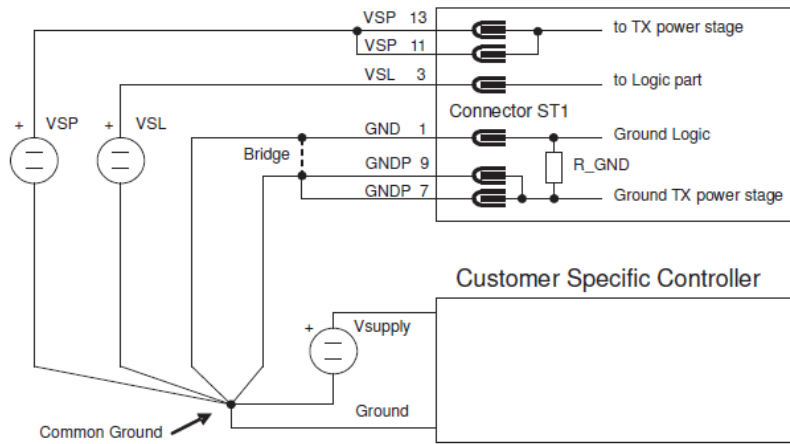

Figure 5.4 External Ground Connection

5.3 More Tuning

5.3.1 RXSS

For users who utilize the RXSS- signal, its adjustment pot (R60) has moved locations about 90° counter-clockwise from its original position (blue adjustment pot in the figure below).

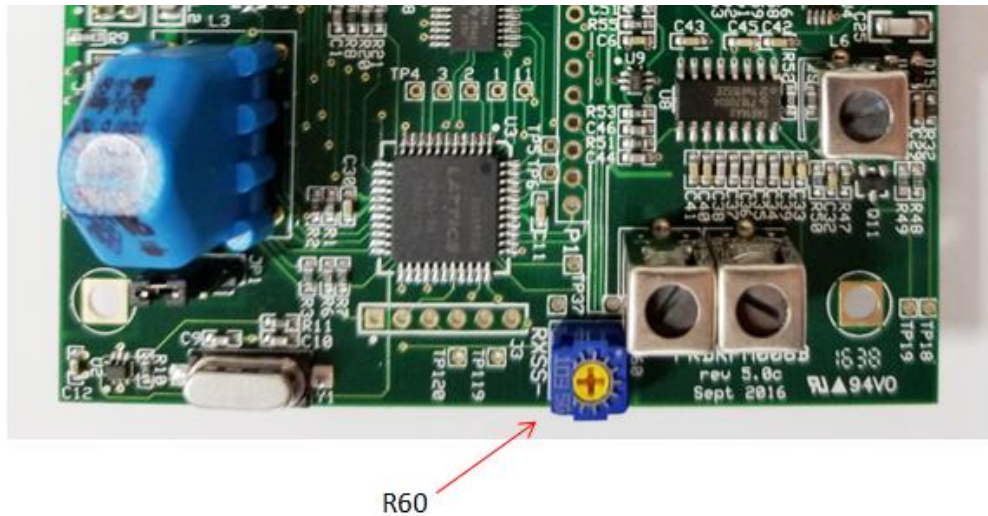

Figure 5.5 RXSS Adjustment Pot

The RFM has a built-in receive signal field strength detector with the output signal RXSS- and an on-board potentiometer (R60) to adjust the threshold level of field strength detection. The digital output RXSS- is used for wireless synchronization of two or more reading units. This is necessary to ensure that if more than one reading unit is in an area, they do not interfere with each other. The Control Module software monitors the RXSS- signal to detect whether other reading units are transmitting. The Control Module can operate the transmitter of the RFM such that the reading units either transmit simultaneously or alternately. In this way the read cycles of each of the reading units occur at the same time or at secure different times.

Depending on the antenna type used and the local noise level, the RXSS- threshold level must be adjusted. This needs to be done after the antenna has been tuned to resonance. It is recommended to use a small screwdriver to adjust the RXSS- threshold level. Turning the potentiometer all the way clockwise (right-hand stop), results in minimum threshold sensitivity, i.e. the RXSS- signal will be activated at high receive field strength. This is the default position and can be used for standard gate antennas. It may be necessary to increase the sensitivity when using ferrite core antennas. If there is high noise level in the area, it is necessary to adjust the RXSS- threshold level.

Adjust the RXSS- threshold level as follows:

1. Turn the RXSS- threshold level potentiometer fully counter-clockwise (left-hand stop).
2. Deactivate the transmitter by jumpering pin 1 to pin 3 of connector J2.
3. Ensure that no other reading units are transmitting, by connecting pin 1 to pin 3 of connector J2 (jumper) of all other RFMs in the area.
4. Monitor the voltage at RXSS- output pin with a voltmeter or an oscilloscope.

5. Turn the RXSS- threshold level adjustment potentiometer on the RFM clockwise, until the RXSS- output is just statically inactive. "Statically" means no voltage spikes present on the RXSS- signal. 'Inactive' means that the receive signal strength is below the RXSS- threshold level and not triggering RXSS- (the RXSS- output voltage remains > 4 V).
6. Remove all jumpers connected to J2



Note: Reducing the RXSS- threshold level sensitivity (turning the potentiometer clockwise), reduces the sensitivity of the built-in receive signal strength detector. This has the effect that the distance for wireless detection of other transmitting reading units is decreased, leading to reduction of wireless synchronization distance. The wireless synchronization distance between two reading units is normally about 15 meters for two aligned stick antennas (RI-ANT S02) with maximum receive field strength detection sensitivity.

When the RXSS- threshold level is adjusted such that it is too sensitive, then the RXSS- output is constantly active (i.e. low RXSS- output level). Therefore, a Control Module assumes that another reading unit is transmitting and continually tries to synchronize to this other reading unit. As a result, the reading repetition rate decreases from approximately 10 down to 5 readings per second. This reading unit can additionally no longer synchronize to other reading units, causing interference with other reading units and reading at all units becomes impossible.

The RXSS- threshold level must be adjusted individually for every RFM and reading system antenna. In addition, the RXSS- threshold level must be individually adjusted to the local noise level in the application area where the antenna is used.

As high noise levels mean that the RXSS- threshold level must be adjusted to a less sensitive value, it is recommended to reduce the local noise level in order to have high synchronization sensitivity and a long reading distance.

The RXSS- threshold level must be adjusted so that no spikes occur on the RXSS- signal output since these leads to incorrect synchronization. An oscilloscope should therefore be used when adjusting the threshold level.

The Remote Tuning Sender (RTS) or Antenna Tuning Indicator (RI-ACC-ATI2) accessory can be used to adjust the RXSS- threshold level, since both of these automatically switch off the transmitter and have an internal spike extension circuit, which causes the RXSS- threshold level to be adjusted such that no spikes occur on the RXSS- output

5.3.2 Other jumpers

The jumpers on the main board which replace the original 3 slide switches (SW1) of the RI-RFM-008B are located behind the resettable fuse next to connector J1.

These jumpers are rarely used but can be accessed by bending the fuse slightly outward.

The right-most jumper (JP2.1-2) is used for Carrier Phase Synchronization (CPS) in some multi RFM systems.

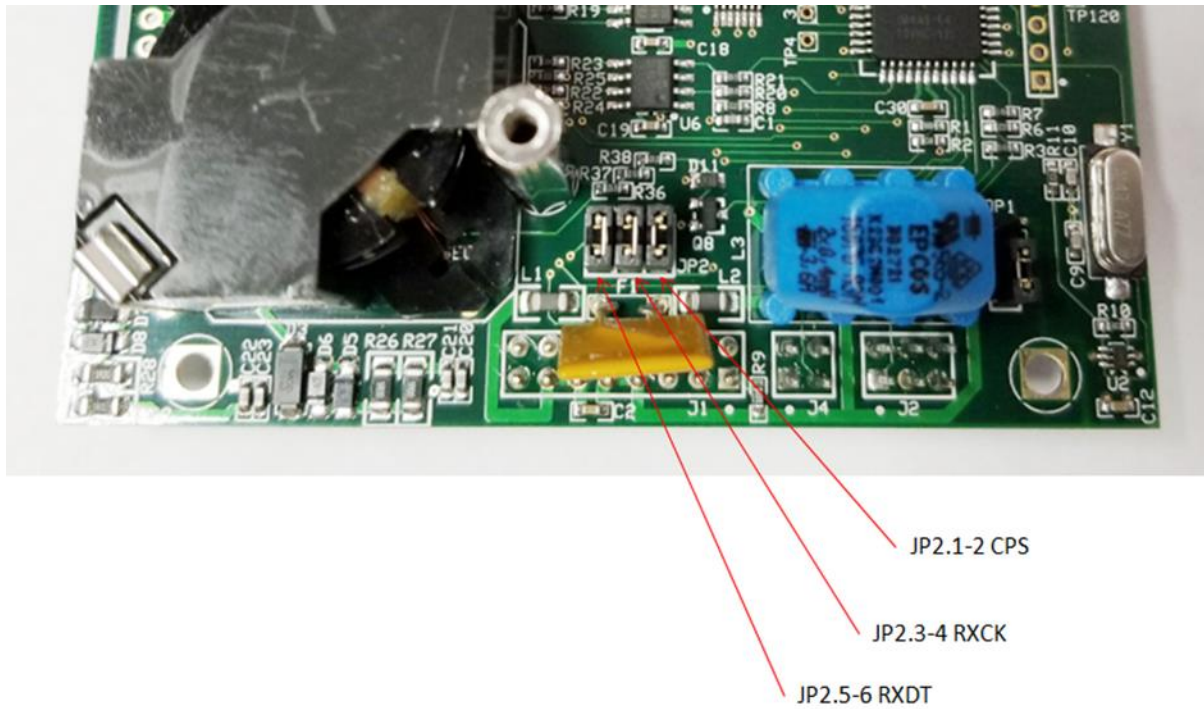

Figure 5.6 Other Jumpers

6 Characteristics

6.1 Mechanical Dimensions PRDRFM008B

Length:	93mm \pm 1mm
Width:	83mm \pm 1mm
Height:	44mm \pm 1.5mm
Weight:	140g

The dimensions for the holes are given in Figure 6.1. All dimensions are in mm with a tolerance of \pm 0.5mm unless otherwise noted.

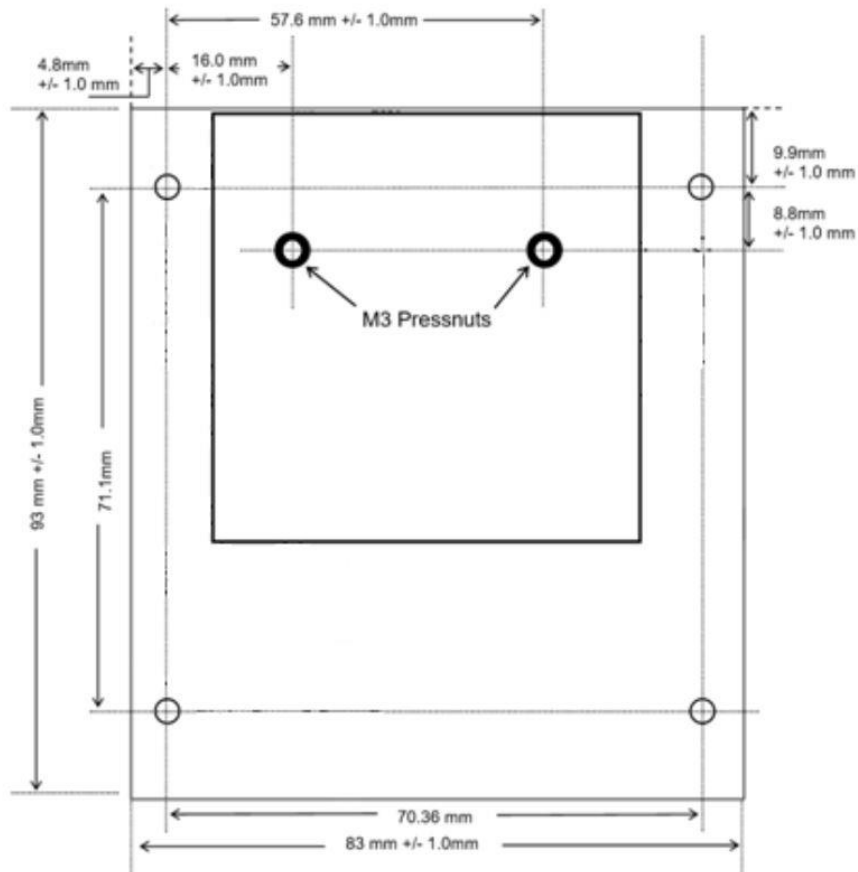

Figure 6.1 Mechanical Dimensions PRDRFM008B



Note: The heatsink is connected to the antenna resonator ground GNDA. When connecting the heatsink to a housing, it must be insulated from the housing.

6.2 Mechanical Dimensions PRDACC008C

Length:	115mm \pm 1mm
Width:	69.2mm \pm 1mm
Height:	21mm \pm 1.5mm
Weight:	75g

The dimensions are given in Figure 6.1. All dimensions are in mm with a tolerance of $\pm 0.5\text{mm}$ unless otherwise noted.

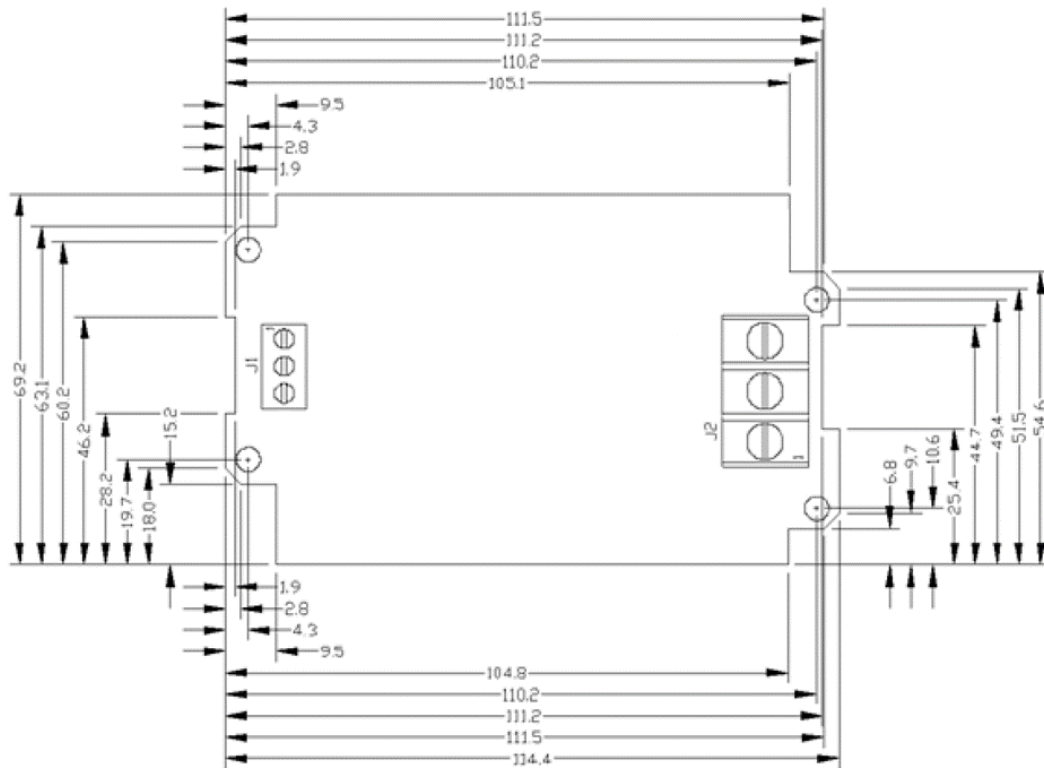

Figure 6.2 Mechanical Dimensions PRDACC008C

6.3 Temperature Range

Operating Temperature Range: 0°C to $+70^{\circ}\text{C}$
 Storage Temperature Range: -40°C to $+85^{\circ}\text{C}$

6.4 Recommended Operating Conditions – Electrical Characteristics



Exceeding recommended maximum ratings may lead to permanent damage of the RFM. The RFM must not be operated in continuous transmit mode when high power output is chosen. Install suitable heatsinks when operating the RFM at pulse widths smaller than 50%

Table 6.1 shows the recommended operating conditions.

Symbol	Parameter	min.	typ.	max.	Unit
V_VSP	Supply voltage of transmitter power stage	7.0	12.0	24.0	V DC
I_VSP	Current consumption of transmitter power stage - refer to the formula below		1.0	1.7	Apeak
P_VSP	Peak pulse power input to transmitter power stage ($I_{VSP} * V_{VSP} * \text{Duty Cycle}$)			20	W
V_ANT	Antenna resonance voltage		250	380	Vpeak
V_ANT-25	Antenna resonance voltage (Pulse width setting $\leq 25\%$)			200	Vpeak
V_ANT-ATI	Minimum antenna resonance voltage for correct operation of ATI	25			Vpeak

V_VSL	Supply voltage input for logic part	7.0		24.0	V DC
I_VD	External current load on internal regulated logic supply voltage output			1.0	mA

Table 6.1: Operating Conditions



Note: Free-air temperature is the air temperature immediately surrounding the RFM. If the module is incorporated into a housing, it must be guaranteed by proper design or cooling that the internal temperature does not exceed the recommended operating conditions.

To keep power consumption (P_VSP) below 20W, it is advisable to limit I_VSP. The maximum allowed value, dependent on the configuration, can be determined as follows (in the following examples a supply voltage of 24 V_VSP is used):

$$I_{VSP} = P_{VSP} / (V_{VSP} \times \text{Duty Cycle})$$

where Duty Cycle = Power-on-time / Total read cycle time

Example 1: Using Standard/Default Settings (≈ 10 read cycles/second):

$$I_{VSP} = 20W / (24V \times 0.5) = 1.66 \text{ A} \quad \text{Duty Cycle} = 50\text{ms} / 100\text{ms} = 0.5$$

Example 2: Configured to No Sync (≈ 12 read cycles/second):

$$I_{VSP} = 20W / (24V \times 0.625) = 1.33 \text{ A} \quad \text{Duty Cycle} = 50\text{ms} / 80\text{ms} = 0.625$$

The following methods can be used to measure the actual I_VSP value:

1. Use a battery powered oscilloscope to measure the voltage drop across a 0.1 Ohm resistor placed in the DCIN+ line, and then calculate the actual current using the formula $I = V/R$.
2. If a battery powered oscilloscope is not available, measure the potential at both sides of the 0.1 Ohm resistor (signal probe) with the GND probe at DCIN- and determine the potential difference.

Ensure that the measured I_VSP value does not exceed the calculated value.

Symbol	Parameter	min.	typ.	max	Unit
I_VSL	Supply current for logic and receiver part in transmit and receive mode	14	18	22	mA
ViL	Low level input voltage of TXCT-	0	0.4	0.8	V
ViH	High level input voltage of TXCT-	2.4		5.0	V
VoL	Low level output voltage of RXDT and RXCK	0	0.4	0.8	V
VoH	High level output voltage of RXDT and RXCK	4.0		5.25	V
VoL_R	Low level output voltage of RXSS-			0.8	V

VoH_R	High level output voltage of RXSS- (see note below)			5.25	V
Fan-In	Low power Schottky compatible fan-in of signals TXCT- (I _{in} = -400μA)			1	-
I_IN- TXCT-	Input current for TXCT- signal, when the Accessory Module RI-ACC-ATI2 is connected	2.0	2.5	3.0	mA
Fan-Out	Low power Schottky compatible fan-out of signals RXDT and RXCK			3	-
FanOut_ RI	Low power Schottky compatible fan-out of signal RXSS- (low level only)			1	-
FanOut_ Rh	Low power Schottky compatible fan-out of signal RXSS- (high level only) (see note below)				
l_J1	Cable length for connecting J1 of RFM to a Control Module using flat cable	0	0.5	2.0	m
l_CPS	Cable length for connecting the Carrier Phase Synchronization signal between two RFMs	0	1.0	5.0	m
n_CPS	Number of oscillator SLAVE RFMs, which can be driven from one oscillator MASTER RFM	1		5	-
Com_Mo de	Common Mode Noise reduction ratio for noise coupled to both antenna terminals ANT1 and ANT2		20		dB
R_GND	Decoupling resistor between GND and GNDP (± 1%)	64.3	68	68.7	Ohm

Table 6.2: Electrical Characteristics



Note: RXSS- has an internal pull-up resistor of 10kOhm. The parameter VoH_R therefore depends on application specific external components.

Symbol	Parameter	min.	typ.	max	Unit
t_TX	Transmit burst length for correct operation (see note below)	15	50	100	ms
t_dtck	Delay time from beginning of data bit at RXDT being valid to positive slope of RXCK signal	20			μs
t_dtvd	Time for data bit of RXDT signal being valid after positive slope of RXCK	90			μs
t_ckhi	Time for clock signal RXCK being high	55			μs
t_ri	Necessary rise and fall times for input signal TXCT- and TXCT-R			1	μs
t_fi				1	μs
t_ro	Rise and fall time of output signals RXDT and RXCK			1	μs
t_fo				1	μs

t_ro_R	Rise time of output signal RXSS- (no external connection)			1	μs
t_fo	Fall time of output signal RXSS-			1	μs
tss_01Tl	Propagation delay time from positive slope of TXCT- to positive slope of RXSS- signal (maximum sensitivity)	500	1000	1500	μs
tss_10Tr	Propagation delay time from negative slope of TXCT- to negative slope of RXSS- signal (minimum sensitivity)	50	100	200	μs
t_short	Maximum time of short circuit between antenna terminals ANT1 and ANT2 and short circuit of ANT1 or ANT2 to GNDA			10	s

Table 6.3: Timing Characteristics



Note: Due to transponder parameters, a minimum charge-up time of 15ms is necessary. Decreasing charge-up time decreases read range due to less energy is sent to the transponder.



The parameter t_short refers to a static short circuit of the antenna terminals. Shorting the antenna terminals during operation may cause permanent damage to the ATB.

7 Regulatory Notes

Prior to operating the RFM and/or ATB, the required relevant government agency approvals must be obtained. Sale, lease or operation in some countries may be subject to prior approval by government or other organizations.

7.1 Europe

The equipment complies with the Radio Equipment Directive (RED) 2014/53/EU. when used for its intended purpose.



A CE Declaration of Conformity for the RFM and the ATB are available from Protagd.

Any device or system incorporating this module in any other than the originally tested configuration needs to be verified against the requirements of the Radio Equipment Directive (RED) 2014/53/EU. A separate Declaration of Conformity must be issued by the system integrator or user of such a system prior to marketing it and operating it in the European Community.

It is the responsibility of the system integrators to get their complete system tested and obtain approvals from the appropriate local authorities before operating or selling the system.

7.2 USA

The RFM and the ATB are considered by the Federal Communications Commission (FCC) to be a "subassembly". As such, no prior approval is required to import, sell or otherwise market them in the United States. To form a functioning radio frequency system, the Reader must be connected to a suitable antenna and power supply.

Such a system containing the RFM and/or the ATB may have to comply with the limits pursuant to part 15 of the FCC rules. It is the responsibility of the system integrators to get their complete system tested and to obtain approvals from the appropriate local authorities before operating or selling this system.

8 Appendix

8.1 Field Strength Adjustment

The magnetic field strength generated determines the charge-up distance of the transponder. The higher the magnetic field strength, the further the transponder charge-up distance. The charge-up distance does not, however, increase linearly with the field strength.

The reading distance of a transponder is determined, amongst other factors, by the charge-up distance and the local noise level. Increasing the charge-up field strength does not necessarily increase the reading distance.

The field strength generated by the RFM depends on the four factors listed below:

1. Q factor of the antenna.

The Q factor is a measure of the efficiency of the antenna and therefore the higher the Q factor of the antenna coil, the higher the field strength generated by the RFM, assuming all other parameters remain unchanged. The Q factor of the antenna itself depends on the cross-sectional area of the wire, the wire type, the size of the antenna and the type of antenna (air or ferrite). The larger the cross-sectional area of the RF braided wire, the higher the Q factor of the antenna. RF braided wire gives a higher Q factor than solid wire assuming all other parameters remain unchanged. Because of the skin effect, the ideal diameter for each strand within the braided wire is 0.36mm (0.014") at 134kHz. A high-Q antenna typically contains 16 to 20 strands of 0.36 copper wire.

2. Size of the antenna.

The larger the antenna, the higher the field strength which is generated by the RFM, since the antenna covers a larger area and thus generates a higher flux assuming all other parameters remain unchanged. Large antennas have less immunity to noise for receive functions than small antennas.

3. Supply voltage of the RFM power stage.

The higher the supply voltage of the RFM transmitter power stage (VSP voltage), the higher the field strength which is generated by the RFM assuming that all other parameters remain unchanged. However, the generated field strength does not increase linearly with VSP supply voltage. In addition, ferrite core antennas show saturation effects (saturation means here that the ferrite core cannot generate more magnetic field strength, even with a higher input current).

The RFM will automatically limit the transmitter power when the output voltage reaches approximately 380V_{peak}. At that point, increasing VSP will not increase output power.

4. The oscillator signal pulse width.

The bigger the selected transmitter oscillator signal pulse width, the higher the magnetic field strength which is generated by the RFM, since more power is fed into

the antenna resonator by the transmitter power stage assuming that all other parameters remain unchanged.

The generated field strength can be measured in several ways. It may be measured using a calibrated field strength meter or by measuring the antenna resonance voltage using an oscilloscope and then calculating the field strength.

In summary: the generated field strength of an antenna can be adjusted with the supply voltage VSP of the RFM transmitter power stage and by selecting the corresponding oscillator signal pulse width. To alter the pulse width, see Section 8.2 below.

The field strength can be fine-tuned to meet FCC/R&TTE regulations with selection of the oscillator signal pulse width in a wide range of both larger and smaller values.



This damping option can be used together with the Protagd standard antenna PRDANTG01. Only a certain maximum antenna resonance voltage is allowed for this option. Please refer to 6.4 for details.



Note: For correct adjustment of the field strength according to FCC/R&TTE values, especially for customized antennas, a calibrated field strength meter must be used.

8.2 Adjustment of Oscillator Signal Pulse Width

The RFM has a built-in feature to allow setting of the pulse width of the transmitter signal coming from the oscillator. This enables the generated field strength to be reduced from 50% down to 0%.

For this purpose, a pulse width setting resistor may be inserted between J4 pins 3 and 4 on the RFM. Inserting a smaller resistance value decreases the pulse width and thus also the field strength. As default, no resistor is connected, thus selecting the maximum pulse width of 50% and the maximum field strength. By connecting a shorting bridge, the smallest pulse width of approximately 0% is selected.

Table 14 provides an overview of oscillator signal pulse width and corresponding field strength reduction when different oscillator signal pulse widths are selected by connecting different resistor values.

Resistor value [Ω]	Oscillator signal pulse width [%]	Field strength reduction [dB]
open	50	0
151k	37	-3
59k	25	-6
17k	12	-12
10k	6	-18
shorted	0	∞

Table 8.1: Oscillator Pulse Width vs. Resistor Value



When using pulse widths smaller than 50%, the RFM transmitter power stage works less efficiently. This leads to an increased power dissipation and thus to a higher temperature of the transmitter power stage. Ensure that the antenna resonance voltage does not exceed 200 V_p when the selected oscillator signal pulse width setting is smaller than 25%.



Note: The pulse width for an oscillator signal pulse width setting of 5% and smaller is extremely short. The pulse response of the RFM transmitter power stage to this short pulse is different for each unit. To have reproducible field strength values for different RFMs, it is not recommended to use the smallest pulse width setting.

Experimentation is made easier by connecting a 200K to 500K ohm 10-turn potentiometer (pot) between male header J4 pins 3 and 4 (see Figure 8.1). Adjust the pot and wait until the temperature of the antenna or RFM settles before measuring. This is a relatively slow process for antennas like the PRDANTS01C which is cast in resin. In this case, a stable temperature requires 20 to 30 minutes between adjustments.

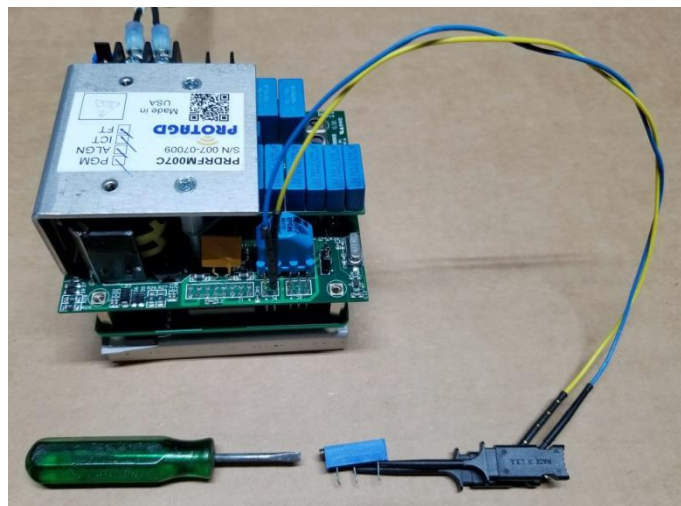

Figure 8.1 Using a 10-turn pot to experiment with power output

Once a value is determined, the resistor needs to be affixed to the RFM. The easy way to do this is to use a 2-pin female header as shown in Figure 8.2. This particular one is from Sullins Connector, part number PPPC021LFBN-RC (Digikey S7035-ND).

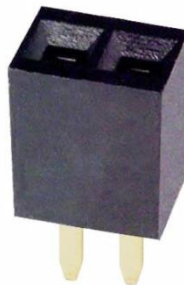

Figure 8.2 Two-pin Female header

A 3216 metric (1206 imperial) size resistor can be soldered across the male pins at the bottom of the female header. A through-hole resistor with the leads bent into a 'U' shape works well or an SMT resistor size 0805 or 1206 fits well. In either case, the assembly can be covered by heat shrink tubing as seen in Figure 8.3.

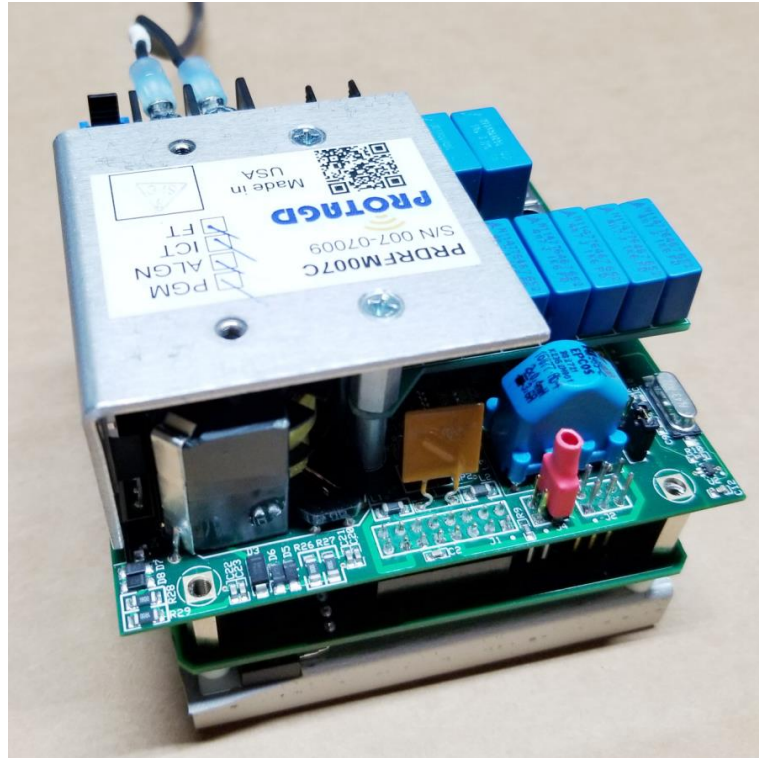

Figure 8.3 Resistor Assembly (red) plugged onto the PRDRFM007C

8.3 Transmitter Carrier Phase Synchronization

In some applications it is necessary to use several charge-up antennas close to each other. Under these circumstances, the magnetic charge-up fields generated by different antennas superimpose on each other and may cause a beat effect on the magnetic charge-up field, due to the slightly different transmit frequencies of different RFMs.

The impact of this effect depends on three factors:

1. Antenna size:

The larger the size of the antennas, the further the distance between the antennas must be, so that this effect does not occur.

2. Magnetic field strength:

The stronger the generated magnetic field strength, the further the distance between the antennas must be such that the effect does not occur.

3. Orientation and distance between antennas:

Increasing the distance between antennas decreases the impact of this effect.



Note: Putting two antennas close to each other changes the antenna inductance, so that the antennas may no longer be tuneable to resonance.

If several antennas are used close to each other, a check should be made to determine if the charge-up field strength changes regularly (i.e. beat effect). This may be checked by verifying the antenna resonance voltage with an oscilloscope. If the antenna resonator voltage changes periodically by more than approximately 5% of the full amplitude it is appropriate to use wired transmitter carrier phase synchronization.

In addition, the distances given in Table 15 can be used as a guideline to determine when it is necessary to cross-check for beat effect. If these distances are less than the value given in Table 15, a check for beat effect should be made. The values given refer to the distances shown in Figure 11 and are valid for maximum charge-up field strength.

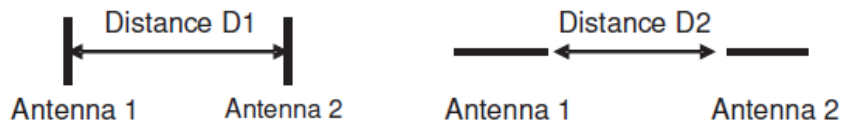

Figure 8.4 Distance between Antennas (top view)

Antenna type	Distance D1 [m]	Distance D2 [m]
PRDANTS02 <=> PRDANTS02	0,8	1,0
PRDANTG01 <=> PRDANTG01	1.7	1.5
PRDANTG02 <=> PRDANTG02	1.3	1.0

Table 8.2: Maximum Distances between Antennas

This effect will not occur if the transmitters of different RFMs are operated from the same oscillator signal. This is the reason why the pulse width modulated oscillator signal is accessible at the connector J1.

Configuration

Master or Slave setting of an RFM is determined by the jumper between JP2 pins 1 and 2. If this jumper is inserted, the RFM is a MASTER, if removed, it is a SLAVE. When an RFM has been configured as a master, then J1 pin 12 of this unit should be connected to J1 pin 16 of the slave units to allow the master oscillator output (CPS_OUT) to drive the slave oscillator inputs (CPS_IN). The logic ground (e.g. J1 pin 1) of both master and slave units must be connected.



Use overvoltage protection components at the CPS connector for CPS lines between 0.5m and 5m.



Note: When using the transmitter Carrier Phase Synchronization feature, it is absolutely necessary that the read cycles of each of the different Control Modules are synchronized. When the transmitter of the oscillator MASTER RFM is not activated by its Control Module, the

oscillator signal output of the oscillator MASTER RFM is disabled. This means that all the oscillator SLAVE RFMs have no transmitter oscillator input signal and thus none of the oscillator SLAVE RFMs are able to transmit.

The read cycles of all RFMs connected to this CPS interface must be synchronized and all read cycles must occur simultaneously. Refer to the Hardware and Software Manuals for the Protagd Control Modules for more information about the necessary wiring and settings for synchronization of the RFM when using transmitter Carrier Phase Synchronization (CPS). If an application requires more than one RFM to be used, or a longer Carrier Phase Synchronization line than that specified in chapter 2, Specifications, must be used, it is necessary to drive the pulse width modulated oscillator signal via a differential interface such as an RS422 interface.

8.4 Noise Considerations

Noise can have a negative effect on the receive performance of the RFM. There are two kinds of noise: radiated and conducted. Their characteristics are shown in Table 16.

	Radiated Noise	Conducted Noise
Source	Inductive parts for example: deflection coils, motor coils.	Power units, for example: motors, switched mode power supplies. Can be seen as voltage spikes or ripple voltage.
Path	Via magnetic fields.	Galvanically conducted via all cables (supply and interface) connected to the RFM.
Effect	Disturbs receive function by magnetic interference with signal from transponder at the antenna.	Leads to malfunction and reduced sensitivity of receiver circuitry due to, for example, interfered supply voltage. Conducted noise can also cause radiated noise.

Table 8.3: Characteristics of Radiated and Conducted Noise

Method for detecting and distinguishing between noise types:

The principle of this procedure is to eliminate any conducted noise from the supply and all interface lines. To do this test, the RFM must be powered from a battery (for example: 9 V, 20 mA) in order to eliminate any conducted noise from a power supply. Conducted noise via the interface lines is eliminated for this test by simply disconnecting all interface lines to the RFM. The measurement criteria for low noise is the amplitude of the receive signal strength detector of the RFM.

The test pin RSTP at connector J1 pin 10 carries an analog output voltage indicating the receive signal strength. This voltage should be measured in combination with the antenna PRDANTG02. The necessary set-up for this test is shown in Figure 12. This configuration operates the RFM from a battery and has no interface line connected. As the transmitter is switched off in this configuration, a normal battery may be used. A low noise level is indicated by an RSTP voltage of less than 1.0 VDC when using antenna PRDANTG02.



Note: Both noise types can be either differential or common mode noise. Use common mode noise filters (for example: a BALUN

transformer) to reduce common mode noise and use selective filters to reduce differential noise.

The following procedure for testing for noise impact should be implemented when the normal set-up for the RFM and antenna gives bad reading distances, even though the antenna is correctly tuned for sufficient transponder charge-up.

Try the configuration shown in Figure 8.5. If this configuration shows bad noise conditions (RSTP voltage more than approximately 1.0 VDC) then the problem is radiated noise.

Eliminate noise sources or try special antennas (e.g. noise-balanced antennas).

1. When the configuration of Figure 8.5 shows good noise conditions (RSTP voltage less than 1.0 VDC) then the problem is conducted noise.
2. Change the configuration so that the interface lines are again connected to the RFM with the transmitter still switched off. If the RSTP voltage now indicates bad noise conditions, the conducted noise is coming via the interface lines.
3. Try to eliminate the noise on the interface lines.
4. When the configuration above (interface lines connected) shows good noise conditions (RSTP voltage less than 1.0 VDC), then the problem is conducted noise via the supply lines.
5. Try to eliminate the noise on the supply lines.

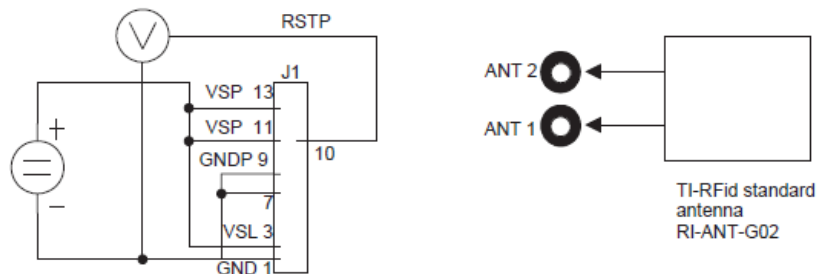

Figure 8.5 Noise Testing Configuration

IMPORTANT NOTICE

Protagd reserves the right to make corrections, modifications, enhancements, improvements, and other changes to its products and services at any time and to discontinue any product or service without notice. Customers should obtain the latest relevant information before placing orders and should verify that such information is current and complete. All products are sold subject to Protagd's terms and conditions of sale supplied at the time of order acknowledgment.

Protagd warrants performance of its hardware products to the specifications applicable at the time of sale in accordance with Protagd's standard warranty. Testing and other quality control techniques are used to the extent Protagd deems necessary to support this warranty. Except where mandated by government requirements, testing of all parameters of each product is not necessarily performed.

Protagd assumes no liability for applications assistance or customer product design. Customers are responsible for their products and applications using Protagd components. To minimize the risks associated with customer products and applications, customers should provide adequate design and operating safeguards.

Protagd does not warrant or represent that any license, either express or implied, is granted under any Protagd patent right, copyright, mask work right, or other Protagd intellectual property right relating to any combination, machine, or process in which Protagd products or services are used. Information published by Protagd regarding third-party products or services does not constitute a license from Protagd to use such products or services or a warranty or endorsement thereof. Use of such information may require a license from a third party under the patents or other intellectual property of the third party, or a license from Protagd under the patents or other intellectual property of Protagd.

Reproduction of Protagd information in Protagd data books or data sheets is permissible only if reproduction is without alteration and is accompanied by all associated warranties, conditions, limitations, and notices. Reproduction of this information with alteration is an unfair and deceptive business practice. Protagd is not responsible or liable for such altered documentation. Information of third parties may be subject to additional restrictions.

Resale of Protagd products or services with statements different from or beyond the parameters stated by Protagd for that product or service voids all express and any implied warranties for the associated Protagd product or service and is an unfair and deceptive business practice. Protagd is not responsible or liable for any such statements.

Protagd products are not authorized for use in safety-critical applications (such as life support) where a failure of the Protagd product would reasonably be expected to cause severe personal injury or death, unless officers of the parties have executed an agreement specifically governing such use. Buyers represent that they have all necessary expertise in the safety and regulatory ramifications of their applications, and acknowledge and agree that they are solely responsible for all legal, regulatory and safety-related requirements concerning their products and any use of Protagd products in such safety-critical applications, notwithstanding any applications-related information or support that may be provided by Protagd. Further, Buyers must fully indemnify Protagd and its representatives against any damages arising out of the use of Protagd products in such safety-critical applications.

Protagd products are neither designed nor intended for use in military/aerospace applications or environments. Buyers acknowledge and agree that any such use of Protagd products is solely at the Buyer's risk, and that they are solely responsible for compliance with all legal and regulatory requirements regarding such use.

Protagd products are neither designed nor intended for use in automotive applications or environments. Buyers acknowledge and agree that, if they use any Protagd products in automotive applications, Protagd will not be responsible for any failure to meet such requirements.