

WINSTAR Display

OLED SPECIFICATION

Model No:

WEX025664BWAP3N00000

SPECIFICATION

Version: N

CUSTOMER :

MODULE NO. : WEX025664BWAP3N00000

APPROVED BY:
(FOR CUSTOMER USE ONLY)

SALES BY	APPROVED BY	CHECKED BY	PREPARED BY
RELEASE DATE:			

APPROVAL FOR SPECIFICATIONS ONLY

APPROVAL FOR SPECIFICATIONS AND SAMPLE

MODEL NO :

RECORDS OF REVISION			DOC. FIRST ISSUE
VERSION	DATE	REVISED PAGE NO.	SUMMARY
0	2015/08/03		First release
A	2015/12/11		Modify Life Time
B	2016/03/23		Modify Static electricity test
C	2016/05/04		Modify Interface Pin Function.
D	2016/11/10		Added IC P/N.
E	2016/11/22		Add FPC bending rule
F	2019/08/30		Modify Precautions in use of OLED Modules
G	2019/12/18		Modify Reliability Test and measurement conditions & Inspection specification:" Accept no dense" modify to "ignore"& Precautions
H	2020/06/29		Modify Interface Pin Function
I	2020/07/28		Modify Contrast Ratio
J	2020/08/27		Modify Inspection specification
K	2020/10/30		Modify Drawing & DC Electrical Characteristics & Optical Characteristics & Reliability test Condition & Storage Precautions Add Application recommendations & Initial code

L	2021/01/21		1.Modify VCC Min value 2.Electrical Characteristics & Initial code Add notes
M	2021/02/25		Modify Precautions in use of OLED Modules
N	2021/07/16		Modify Drawing

Contents

- 1.Module Classification Information
- 2.General Specification
- 3.Contour Drawing & Block Diagram
- 4.Interface Pin Function
- 5.Absolute Maximum Ratings
- 6.Electrical Characteristics
- 7.Optical Characteristics
- 8.OLED Lifetime
- 9.Reliability
- 10.Inspection specification
- 11.Precautions in use of OLED Modules

1.Module Classification Information

W E X 025664 B W A P 3 N 0 0 0 00
 ① ② ③ ④ ⑤ ⑥ ⑦ ⑧ ⑨ ⑩ ⑪ ⑫ ⑬ ⑭

1	Brand : WINSTAR DISPLAY CORPORATION			
2	E : OLED			
3	Display Type	H : COB Character	G : COB Graphic	
		O : COG	F : COG + FR	
		P : COG + FR + PCB	X : TAB	
		A : COG + PCB		
4	Dot Matrix : 256 * 64			
5	Serials code			
6	Emitting Color	A : Amber	R : Red	C : Full Color
		B : Blue	W : White	
		G : Green	L : Yellow	
		S : Sky Blue	X : Dual Color	
7	Polarizer	P : With Polarizer; N: Without Polarizer A : Anti-glare Polarizer		
8	Display Mode	P : Passive Matrix ; N : Active Matrix		
9	Driver Voltage	3 : 3.0~3.3V ; 5 : 5.0V		
10	Touch Panel	N : Without touch panel; T: With touch panel		
11	Product type	0 : Standard 1 : Daylight Readable 2 : Transparent OLED (TOLED) 3 : Flexible OLED (FOLED) 4 : OLED Lighting		
12	Inspection Grade	0 : Standard 2 : Special grade C : Automotive grade Y : Consumer grade		
13	Option	0 : Default ; F : ZIF FPC ; H : Hot bar FPC; D : Demo Kit		
14	Serial No.	Serial number(00~ZZ)Polarizer type: Anti-Glare		

2.General Specification

Item	Dimension	Unit
Dot Matrix	256 x 64 Dots	—
Module dimension	88.0 × 27.8 × 2.15	mm
Active Area	76.778 × 19.178	mm
Pixel Size	0.278 × 0.278	mm
Pixel Pitch	0.3 × 0.3	mm
Display Mode	Passive Matrix	
Display Color	White	
Drive Duty	1/64 Duty	
Gray Scale	4 bits	
IC	SSD1322 (COF)	
Interface	6800, 8080, SPI	
Size	3.12 inch	

3. Contour Drawing & Block Diagram

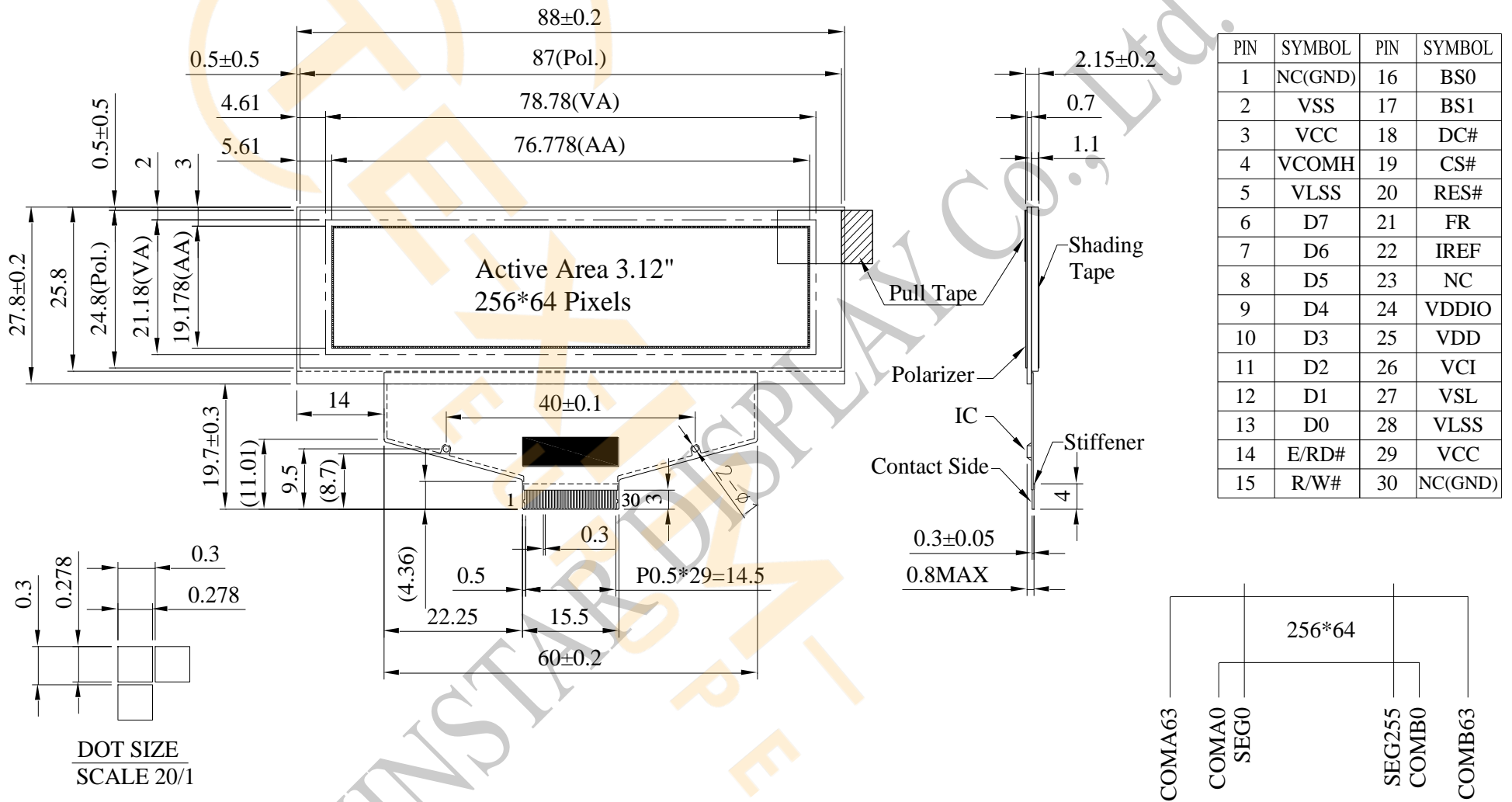

The non-specified tolerance of dimension is $\pm 0.3\text{mm}$.

3.1 Application recommendations

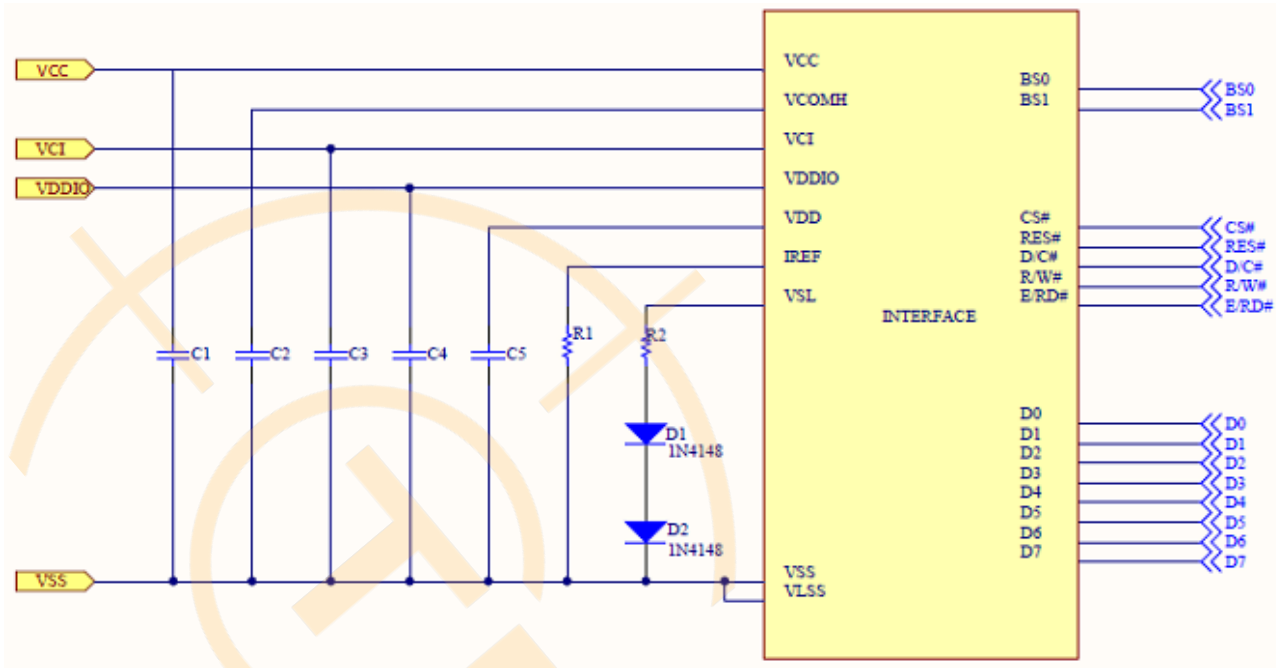

Recommended components :

C3, C4, C5 : 1.0uF

C1, C2 : 4.7uF

D1, D2 : 1N4148, 0.7V

R2 : 50ohm, 1/8W

Bus Interface selection: (Must be set the BS [1:0], refer to item 4)

8-bits 6800 and 8080 parallel, 3 or 4-wire SPI

Voltage at IREF = VCC – 6V. For VCC = 14.5V, IREF = 10uA:

$$R1 = (\text{Voltage at IREF} - \text{VSS}) / \text{IREF}$$

$$= (14.5 - 6)V / 10\mu\text{A} \geq 850\text{K ohm}^{(2)}$$

Note:

- (1). The capacitor value is recommended value. Select appropriate value against module application.
- (2). Minimum value. When OLED product application, then R1 must be greater than the calculated value.

4.Interface Pin Function

Pin Number	Symbol	I/O	Function										
1	N.C. (GND)	P	Ground										
2	VSS	P	Ground.										
3	VCC	P	Power supply for panel driving voltage. This is also the most positive power voltage supply pin.										
4	VCOMH	P	COM signal deselected voltage level. A capacitor should be connected between this pin and VSS.										
5	VLSS	P	Analog system ground pin.										
6~13	D7~D0	I/O	Host Data Input/Output Bus These pins are 8-bit bi-directional data bus to be connected to the microprocessor's data bus. When serial mode is selected, D1 will be the serial data input SDIN and D0 will be the serial clock input SCLK.										
14	E/RD#	I	Read/Write Enable or Read This pin is MCU interface input. When interfacing to a 68XX-series microprocessor, this pin will be used as the Enable (E) signal. Read/write operation is initiated when this pin is pulled high and the CS# is pulled low. When connecting to an 80XX-microprocessor, this pin receives the Read (RD#) signal. Data read operation is initiated when this pin is pulled low and CS# is pulled low. When serial mode is selected, this pin must be connected to VSS.										
15	R/W#	I	Read/Write Select or Write This pin is MCU interface input. When interfacing to a 68XX-series microprocessor, this pin will be used as Read/Write (R/W#) selection input. Pull this pin to "High" for read mode and pull it to "Low" for write mode. When 80XX interface mode is selected, this pin will be the Write (WR#) input. Data write operation is initiated when this pin is pulled low and the CS# is pulled low. When serial mode is selected, this pin must be connected to VSS.										
16	BS0	I	Communicating Protocol Select These pins are MCU interface selection input. See the following table: <table border="1" data-bbox="574 1608 1208 1791"> <thead> <tr> <th>BS[1:0]</th> <th>Bus Interface Selection</th> </tr> </thead> <tbody> <tr> <td>00</td> <td>4 line SPI</td> </tr> <tr> <td>01</td> <td>3 line SPI</td> </tr> <tr> <td>10</td> <td>8-bit 8080 parallel</td> </tr> <tr> <td>11</td> <td>8-bit 6800 parallel</td> </tr> </tbody> </table>	BS[1:0]	Bus Interface Selection	00	4 line SPI	01	3 line SPI	10	8-bit 8080 parallel	11	8-bit 6800 parallel
BS[1:0]	Bus Interface Selection												
00	4 line SPI												
01	3 line SPI												
10	8-bit 8080 parallel												
11	8-bit 6800 parallel												
17	BS1	Note (1) 0 is connected to VSS (2) 1 is connected to VDDIO											

18	D/C#	I	Data/Command Control This pin is Data/Command control pin connecting to the MCU. When the pin is pulled HIGH, the content at D[7:0] will be interpreted as data. When the pin is pulled LOW, the content at D[7:0] will be interpreted as command.
19	CS#	I	Data/Command Control This pin is the chip select input connecting to the MCU. The chip is enabled for MCU communication only when CS# is pulled LOW.
20	RES#	I	This pin is reset signal input. When the pin is pulled LOW, initialization of the chip is executed. Keep this pin pull HIGH during normal operation.
21	FR	O	This pin is No Connection pins. Nothing should be connected to this pin. This pin should be left open individually.
22	IREF	I	Current Reference for Brightness Adjustment This pin is segment current reference pin. A resistor should be connected between this pin and VSS. Set the current lower than 10uA.
23	N.C.	-	Reserved Pin The N.C. pin between function pins are reserved for compatible and flexible design.
24	VDDIO	P	Power Supply for I/O Pin It should be matched with the MCU interface voltage level.
25	VDD	P	Power Supply for Core Logic Circuit Power supply pin for core logic operation. A capacitor is required to connect between this pin and VSS
26	VCI	P	Power Supply for Operation VCI must always be equal to or higher than VDD and VDDIO.
27	VSL	P	Voltage Output Low Level for SEG Signal This is segment voltage reference pin. When external VSL is not used, this pin should be left open. When external VSL is used, this pin should connect with resistor and diode to ground.
28	VLSS	P	Ground of Analog Circuit These are the analog ground pins. They should be connected to VSS externally.
29	VCC	P	Power Supply for OLED Panel These are the most positive voltage supply pin of the chip. They must be connected to external source.
30	N.C. (GND)	P	Ground

5. Absolute Maximum Ratings

Parameter	Symbol	Min	Max	Unit	Notes
Supply Voltage for Operation	VCI	-0.3	4	V	1, 2
Supply Voltage for Logic	VDD	-0.5	2.75	V	1, 2
Supply Voltage for I/O Pins	VDDIO	-0.5	VCI	V	1, 2
Supply Voltage for Display	VCC	-0.5	20	V	1, 2
Operating Temperature	TOP	-40	80	°C	-
Storage Temperature	TSTG	-40	85	°C	-

Note 1: All the above voltages are on the basis of "VSS = 0V".

Note 2: When this module is used beyond the above absolute maximum ratings, permanent breakage of the module may occur. Also, for normal operations, it is desirable to use this module under the conditions according to Section 6 "Electrical Characteristics". If this module is used beyond these conditions, malfunctioning of the module can occur and the reliability of the module may deteriorate.

6. Electrical Characteristics

6.1 DC Electrical Characteristics

Item	Symbol	Condition	Min	Typ	Max	Unit
Supply Voltage for Logic	VDD	—	2.4	2.5	2.6	V
Power Supply for I/O pins	VDDIO	—	1.65	3.0	VCI	V
Low voltage power supply	VCI	—	2.4	3.0	3.5	V
Supply Voltage for Display	VCC	—	10	14.5	15	V
High Level Input	VIH	—	0.8×VDDIO	—	VDDIO	V
Low Level Input	VIL	—	0	—	0.2×VDDIO	V
High Level Output	VOH	—	0.9×VDDIO	—	VDDIO	V
Low Level Output	VOL	—	0	—	0.1×VDDIO	V
50% Check Board operating Current	ICC	VCC =12V	—	24	32	mA
		VCC =14.5V	—	32	42.5	mA

Note 1: Supply Voltage for Logic = VDD core power supply can be regulated from VCI.

Note 2: VCI must be larger than or equal to VDD

Notes 3: The VCC value can be adjusted according to the demand brightness. When VCC is lowered, the brightness decreases or when VCC is increased, the brightness increases. The VCC value is set within the recommended range. The life time of OLED is directly related to the set brightness, and lower brightness helps to improve the life time.

6.2 Initial code

```
void Initial_ic(void)
{
    write_command(0xFD); //set Command Lock
    write_data(0x12);

    write_command(0xAE); //Sleep mode ON (Display OFF)

    write_command(0xB4); //Display Enhancement A
    write_data(0xA2); // Internal VSL
    write_data(0xB5);

    write_command(0xA0); //set Re-map and Dual COM Line mode
    write_data(0x10);
    write_data(0x11);

    write_command(0xCA); //set MUX Ratio
    write_data(0x3F);

    write_command(0xD1); //Display Enhancement B
    write_data(0x82);
    write_data(0x20);

    write_command(0xC1); //set Contrast current
    write_data(0x7D);

    write_command(0xC7); //master Contrast current Control
    write_data(0x0F);

    write_command(0xB3); //set Front Clock Divider/Oscillator Frequency
    write_data(0x61); //105Hz

    write_command(0xB1); //set Phase Length
    write_data(0XF5);

    write_command(0xBB); //set pre-charge voltage
    write_data(0x1F);

    write_command(0xBE); //set VCOMH
    write_data(0x07);

    write_command(0xB6); //set Current Pre-charge Period
    write_data(0x0F);

    write_command(0xB9); // Select Default Linear Gray Scale table

    write_command(0xAB); //Function Selection
    write_data(0x01);

    write_command(0x00); // Enable Gray Scale Table

    write_command(0xA1); //set Display Start Line
    write_data(0x00);

    write_command(0xA2); //set Display Offset
```

```
write_data(0x00);  
  
write_command(0xA6); //set Display Mode  
  
write_command(0x15); //set Column Address  
write_data(0x1C);  
write_data(0x5B);  
  
write_command(0x75); //set Row Address  
write_data(0x00);  
write_data(0x3F);  
  
write_command(0x5C); //Write RAM Command  
  
write_command(0xAF); //Sleep mode OFF (Display ON)  
}
```

Note1: Initial code is for reference only. Please make the best adjustment with the OLED module.

Note2: Command: Set Contrast Control (0xC1) , This command sets the Contrast Setting of the display. The chip has 256 contrast steps from 00h to FFh. The segment output current increases as the contrast step value increases. The segment current increases, the OLED brightness increases.

7. Optical Characteristics

Item	Symbol	Condition	Min	Typ	Max	Unit
View Angle	(V) θ	—	160	—	—	deg
	(H) ϕ	—	160	—	—	deg
Contrast Ratio	CR	Dark	10,000:1	—	—	—
Response Time	T rise	—	—	10	—	μ s
	T fall	—	—	10	—	μ s
Display with 50% check Board Brightness ⁽¹⁾	VCC=12V		60	80	—	cd/m ²
	VCC=14.5V		80	100	—	
CIE _x (White)	(CIE1931)		0.26	0.28	0.30	—
CIE _y (White)	(CIE1931)		0.30	0.32	0.34	—

Note 1: The brightness value is based on the setting of Vcc equal to the Typical value.

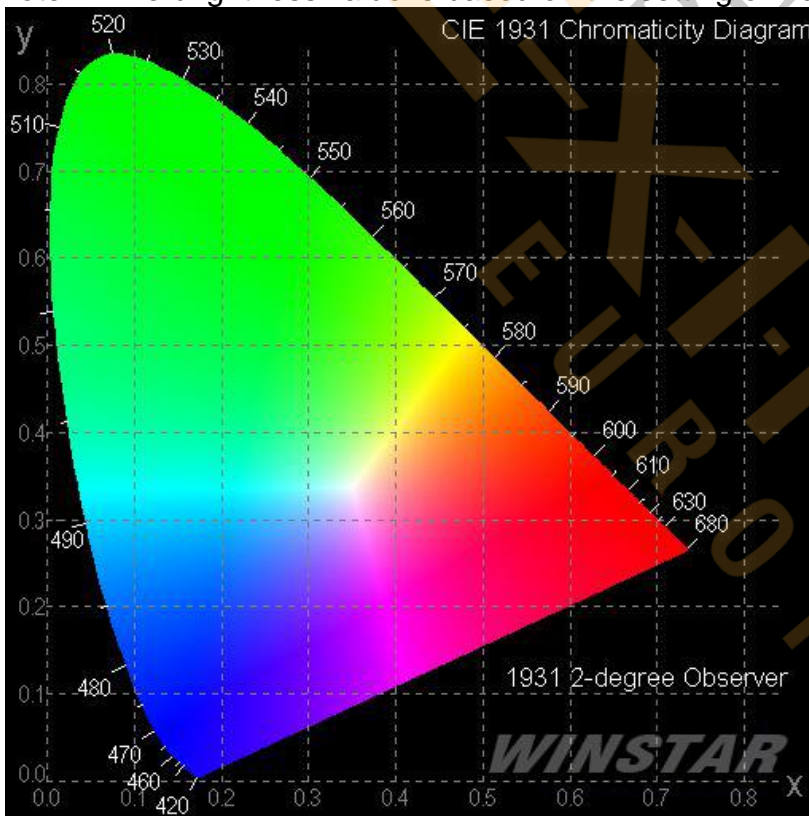

8.OLED Lifetime

ITEM	Conditions	Min	Typ	Remark
Operating Life Time	Ta=25°C / Initial 50% check board brightness 100cd/m ²	20,000 Hrs	—	Note

Notes:

1. Life time is defined the amount of time when the luminance has decayed to <50% of the initial value.
2. This analysis method uses life data obtained under accelerated conditions to extrapolate an estimated probability density function (*pdf*) for the product under normal use conditions.
3. Screen saving mode will extend OLED lifetime.

9. Reliability

Content of Reliability Test

Environmental Test			
Test Item	Content of Test	Test Condition	Applicable Standard
High Temperature storage	Endurance test applying the high storage temperature for a long time.	85°C 240hrs	—
Low Temperature storage	Endurance test applying the low storage temperature for a long time.	-40°C 240hrs	—
High Temperature Operation	Endurance test applying the electric stress (Voltage & Current) and the thermal stress to the element for a long time.	80°C 240hrs	—
Low Temperature Operation	Endurance test applying the electric stress under low temperature for a long time.	-40°C 240hrs	—
High Temperature/ Humidity Storage	Endurance test applying the high temperature and high humidity storage for a long time.	60°C, 90%RH 240hrs	—
High Temperature/ Humidity Operation	Endurance test applying the high temperature and high humidity Operation for a long time.	60°C, 90%RH 120hrs	—
Temperature Cycle	Endurance test applying the low and high temperature cycle. <div style="display: flex; justify-content: space-around; align-items: center;"> -40°C 25°C 80°C </div> <div style="display: flex; justify-content: space-around; align-items: center; margin-top: 5px;"> 30min 5min 30min </div> 	-40°C / 80°C 30 cycles	—
Mechanical Test			
Vibration test	Endurance test applying the vibration during transportation and using.	Frequency: 10~55Hz amplitude: 1.5mm Time: 0.5hrs/axis Test axis: X, Y, Z	—
Others			
Static electricity test	Endurance test applying the electric stress to the finished product housing.	Air Discharge model ±4kv, 10 times	—

*** Supply voltage for OLED system = Operating voltage at 25°C

Test and measurement conditions

1. All measurements shall not be started until the specimens attain to temperature stability. After the completion of the described reliability test, the samples were left at room temperature for 2 hrs prior to conducting the failure test at $23\pm 5^{\circ}\text{C}$; $55\pm 15\%$ RH.
2. All-pixels on/off exchange is used as operation test pattern.
3. The degradation of Polarizer are ignored for High Temperature storage, High Temperature/ Humidity Storage, Temperature Cycle

Evaluation criteria

1. The function test is OK.
2. No observable defects.
3. Luminance: $> 50\%$ of initial value.
4. Current consumption: within $\pm 50\%$ of initial value.

APPENDIX:

RESIDUE IMAGE

Because the pixels are lighted in different time, the luminance of active pixels may reduce or differ from inactive pixels. Therefore, the residue image will occur. To avoid the residue image, every pixel needs to be lighted up uniformly.

10. Inspection specification

Inspection Standard:

MIL-STD-105E table normal inspection single sample level II.

Definition

1 Major defect : The defect that greatly affect the usability of product.

2 Minor defect : The other defects, such as cosmetic defects, etc.

Definition of inspection zone:

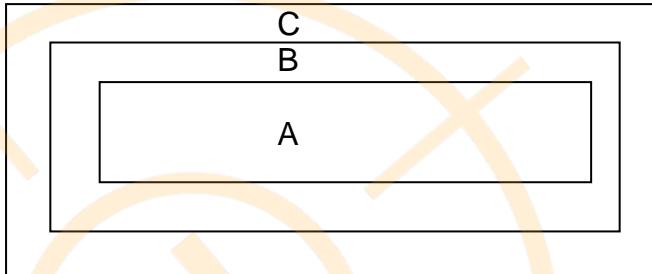

Zone A: Active Area

Zone B: Viewing Area except Zone A

Zone C: Outside Viewing Area



Note: As a general rule, visual defects in Zone C are permissible, when it is no trouble of quality and assembly to customer's product.

Inspection Methods

1 The general inspection : Under fluorescent light illumination: 750~1500 Lux, about 30cm viewing distance, within 45° viewing angle, under 25±5°C.

2 The luminance and color coordinate inspection : By SR-3 or BM-7 or the equal equipments, in the dark room, under 25±5°C.

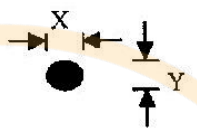
NO	Item	Criterion	AQL
01	Electrical Testing	1.1 Missing vertical, horizontal segment, segment contrast defect. 1.2 Missing character , dot or icon. 1.3 Display malfunction. 1.4 No function or no display. 1.5 Current consumption exceeds product specifications. 1.6 OLED viewing angle defect. 1.7 Mixed product types. 1.8 Contrast defect.	0.65
02	Black or white spots on OLED (display only)	2.1 White and black spots on display $\leq 0.25\text{mm}$, no more than three white or black spots present. 2.2 Densely spaced: No more than two spots or lines within 3mm.	2.5

NO	Item	Criterion	AQL																			
	OLED black spots, white spots, contamination (non-display)	<p>3.1 Round type : As following drawing $\Phi = (x + y) / 2$</p>  <table border="1" data-bbox="738 310 1401 556"> <thead> <tr> <th>SIZE</th> <th>Acceptable QTY</th> <th>Zone</th> </tr> </thead> <tbody> <tr> <td>$\Phi \leq 0.10$</td> <td>ignore</td> <td>A+ B,</td> </tr> <tr> <td>$0.10 < \Phi \leq 0.20$</td> <td>2</td> <td>A+ B</td> </tr> <tr> <td>$0.20 < \Phi \leq 0.25$</td> <td>1</td> <td>A+ B</td> </tr> <tr> <td>$0.25 < \Phi$</td> <td>0</td> <td>A+ B</td> </tr> </tbody> </table>	SIZE	Acceptable QTY	Zone	$\Phi \leq 0.10$	ignore	A+ B,	$0.10 < \Phi \leq 0.20$	2	A+ B	$0.20 < \Phi \leq 0.25$	1	A+ B	$0.25 < \Phi$	0	A+ B	2.5				
SIZE	Acceptable QTY	Zone																				
$\Phi \leq 0.10$	ignore	A+ B,																				
$0.10 < \Phi \leq 0.20$	2	A+ B																				
$0.20 < \Phi \leq 0.25$	1	A+ B																				
$0.25 < \Phi$	0	A+ B																				
03		<p>3.2 Line type : (As following drawing)</p>  <table border="1" data-bbox="609 919 1401 1165"> <thead> <tr> <th>Length</th> <th>Width</th> <th>Acceptable QTY</th> <th>Zone</th> </tr> </thead> <tbody> <tr> <td>---</td> <td>$W \leq 0.02$</td> <td>ignore</td> <td>A+B</td> </tr> <tr> <td>$L \leq 3.0$</td> <td>$0.02 < W \leq 0.03$</td> <td rowspan="2">2</td> <td>A+B</td> </tr> <tr> <td>$L \leq 2.5$</td> <td>$0.03 < W \leq 0.05$</td> <td>A+B</td> </tr> <tr> <td>---</td> <td>$0.05 < W$</td> <td>As round type</td> <td></td> </tr> </tbody> </table>	Length	Width	Acceptable QTY	Zone	---	$W \leq 0.02$	ignore	A+B	$L \leq 3.0$	$0.02 < W \leq 0.03$	2	A+B	$L \leq 2.5$	$0.03 < W \leq 0.05$	A+B	---	$0.05 < W$	As round type		2.5
Length	Width	Acceptable QTY	Zone																			
---	$W \leq 0.02$	ignore	A+B																			
$L \leq 3.0$	$0.02 < W \leq 0.03$	2	A+B																			
$L \leq 2.5$	$0.03 < W \leq 0.05$		A+B																			
---	$0.05 < W$	As round type																				
04	Polarizer bubbles /Dent	<p>4.1 If bubbles are visible, judge using black spot specifications, not easy to find, must check in specify direction.</p> <table border="1" data-bbox="730 1323 1401 1570"> <thead> <tr> <th>Size Φ</th> <th>Acceptable QTY</th> <th>Zone</th> </tr> </thead> <tbody> <tr> <td>$\Phi \leq 0.20$</td> <td>ignore</td> <td>A+B</td> </tr> <tr> <td>$0.20 < \Phi \leq 0.50$</td> <td>3</td> <td>A+B</td> </tr> <tr> <td>$0.50 < \Phi \leq 1.00$</td> <td>2</td> <td>A+B</td> </tr> <tr> <td>$1.00 < \Phi$</td> <td>0</td> <td>A+B</td> </tr> <tr> <td>Total QTY</td> <td>3</td> <td></td> </tr> </tbody> </table> <p>4.2 The polarizer dent follows this specification.</p>	Size Φ	Acceptable QTY	Zone	$\Phi \leq 0.20$	ignore	A+B	$0.20 < \Phi \leq 0.50$	3	A+B	$0.50 < \Phi \leq 1.00$	2	A+B	$1.00 < \Phi$	0	A+B	Total QTY	3		2.5	
Size Φ	Acceptable QTY	Zone																				
$\Phi \leq 0.20$	ignore	A+B																				
$0.20 < \Phi \leq 0.50$	3	A+B																				
$0.50 < \Phi \leq 1.00$	2	A+B																				
$1.00 < \Phi$	0	A+B																				
Total QTY	3																					
05	Scratches	Follow NO.3 OLED black spots, white spots, contamination.																				

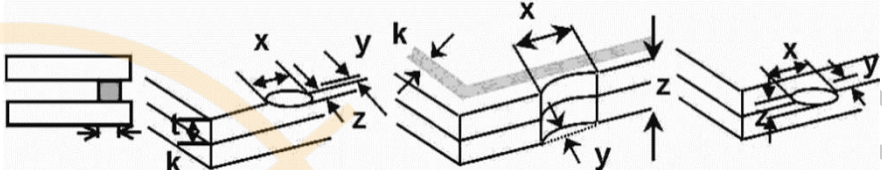
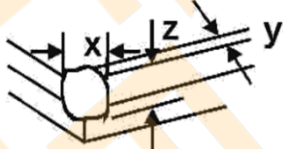
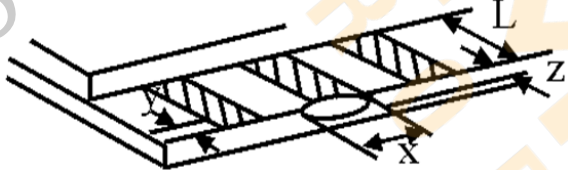
NO	Item	Criterion	AQL																		
06	Chipped glass	<p>Symbols Define: x: Chip length y: Chip width z: Chip thickness k: Seal width t: Glass thickness a: OLED side length L: Electrode pad length: 6.1 General glass chip : 6.1.1 Chip on panel surface and crack between panels:</p>  <table border="1" data-bbox="472 596 1377 720"> <thead> <tr> <th>z: Chip thickness</th> <th>y: Chip width</th> <th>x: Chip length</th> </tr> </thead> <tbody> <tr> <td>$Z \leq 1/2t$</td> <td>Not over viewing area</td> <td>$x \leq 1/8a$</td> </tr> <tr> <td>$1/2t < z \leq 2t$</td> <td>Not exceed 1/3k</td> <td>$x \leq 1/8a$</td> </tr> </tbody> </table> <p>⊙ If there are 2 or more chips, x is total length of each chip.</p> <p>6.1.2 Corner crack:</p>  <table border="1" data-bbox="472 984 1398 1108"> <thead> <tr> <th>z: Chip thickness</th> <th>y: Chip width</th> <th>x: Chip length</th> </tr> </thead> <tbody> <tr> <td>$Z \leq 1/2t$</td> <td>Not over viewing area</td> <td>$x \leq 1/8a$</td> </tr> <tr> <td>$1/2t < z \leq 2t$</td> <td>Not exceed 1/3k</td> <td>$x \leq 1/8a$</td> </tr> </tbody> </table> <p>⊙ If there are 2 or more chips, x is the total length of each chip.</p>	z: Chip thickness	y: Chip width	x: Chip length	$Z \leq 1/2t$	Not over viewing area	$x \leq 1/8a$	$1/2t < z \leq 2t$	Not exceed 1/3k	$x \leq 1/8a$	z: Chip thickness	y: Chip width	x: Chip length	$Z \leq 1/2t$	Not over viewing area	$x \leq 1/8a$	$1/2t < z \leq 2t$	Not exceed 1/3k	$x \leq 1/8a$	2.5
z: Chip thickness	y: Chip width	x: Chip length																			
$Z \leq 1/2t$	Not over viewing area	$x \leq 1/8a$																			
$1/2t < z \leq 2t$	Not exceed 1/3k	$x \leq 1/8a$																			
z: Chip thickness	y: Chip width	x: Chip length																			
$Z \leq 1/2t$	Not over viewing area	$x \leq 1/8a$																			
$1/2t < z \leq 2t$	Not exceed 1/3k	$x \leq 1/8a$																			
06	Glass crack	<p>Symbols : x: Chip length y: Chip width z: Chip thickness k: Seal width t: Glass thickness a: OLED side length L: Electrode pad length 6.2 Protrusion over terminal : 6.2.1 Chip on electrode pad :</p>  <table border="1" data-bbox="472 1654 1377 1734"> <thead> <tr> <th>y: Chip width</th> <th>x: Chip length</th> <th>z: Chip thickness</th> </tr> </thead> <tbody> <tr> <td>$y \leq 0.5\text{mm}$</td> <td>$x \leq 1/8a$</td> <td>$0 < z \leq t$</td> </tr> </tbody> </table>	y: Chip width	x: Chip length	z: Chip thickness	$y \leq 0.5\text{mm}$	$x \leq 1/8a$	$0 < z \leq t$	2.5												
y: Chip width	x: Chip length	z: Chip thickness																			
$y \leq 0.5\text{mm}$	$x \leq 1/8a$	$0 < z \leq t$																			

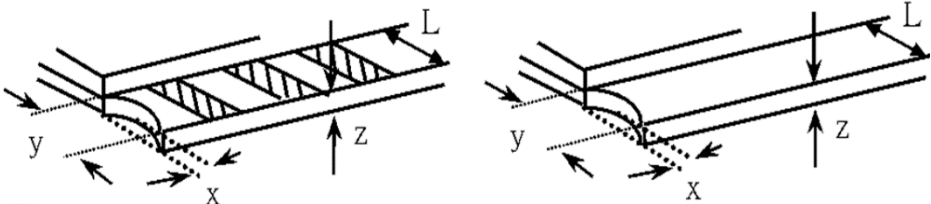
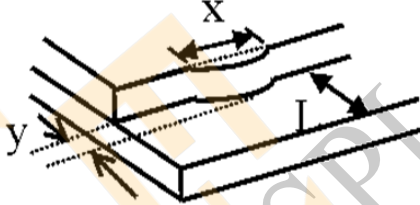
NO	Item	Criterion	AQL										
06	Glass crack	<p>6.2.2 Non-conductive portion:</p>  <table border="1" data-bbox="545 447 1411 531"> <tr> <td>y: Chip width</td> <td>x: Chip length</td> <td>z: Chip thickness</td> </tr> <tr> <td>$y \leq L$</td> <td>$x \leq 1/8a$</td> <td>$0 < z \leq t$</td> </tr> </table> <p>⊙ If the chipped area touches the ITO terminal, over 2/3 of the ITO must remain and be inspected according to electrode terminal specifications. ⊙ If the product will be heat sealed by the customer, the alignment mark not be damaged.</p> <p>6.2.3 Substrate protuberance and internal crack.</p> <table border="1" data-bbox="878 772 1382 856"> <tr> <td>y: width</td> <td>x: length</td> </tr> <tr> <td>$y \leq 1/3L$</td> <td>$x \leq a$</td> </tr> </table> 	y: Chip width	x: Chip length	z: Chip thickness	$y \leq L$	$x \leq 1/8a$	$0 < z \leq t$	y: width	x: length	$y \leq 1/3L$	$x \leq a$	2.5
y: Chip width	x: Chip length	z: Chip thickness											
$y \leq L$	$x \leq 1/8a$	$0 < z \leq t$											
y: width	x: length												
$y \leq 1/3L$	$x \leq a$												
07	Cracked glass	The OLED with extensive crack is not acceptable.	2.5										
08	Backlight elements	<p>8.1 Illumination source flickers when lit.</p> <p>8.2 Spots or scratched that appear when lit must be judged. Using OLED spot, lines and contamination standards.</p> <p>8.3 Backlight doesn't light or color wrong.</p>	0.65 2.5 0.65										
09	Bezel	<p>9.1 Bezel may not have rust, be deformed or have fingerprints, stains or other contamination.</p> <p>9.2 Bezel must comply with job specifications.</p>	2.5 0.65										
10	PCB , COB	<p>10.1 COB seal may not have pinholes larger than 0.2mm or contamination.</p> <p>10.2 COB seal surface may not have pinholes through to the IC.</p> <p>10.3 The height of the COB should not exceed the height indicated in the assembly diagram.</p> <p>10.4 There may not be more than 2mm of sealant outside the seal area on the PCB. And there should be no more than three places.</p> <p>10.5 No oxidation or contamination PCB terminals.</p> <p>10.6 Parts on PCB must be the same as on the production characteristic chart. There should be no wrong parts, missing parts or excess parts.</p> <p>10.7 The jumper on the PCB should conform to the product characteristic chart.</p> <p>10.8 If solder gets on bezel tab pads, OLED pad, zebra pad or</p>	2.5 2.5 0.65 2.5 0.65 0.65 2.5										

		screw hold pad, make sure it is smoothed down.	
--	--	--	--

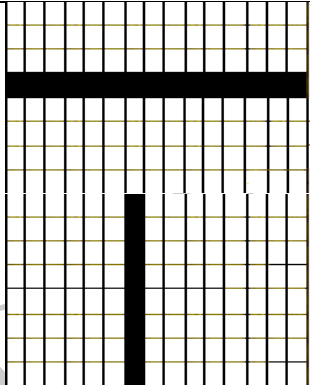
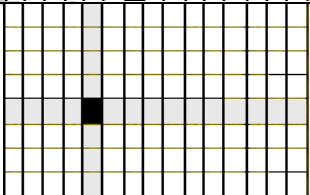
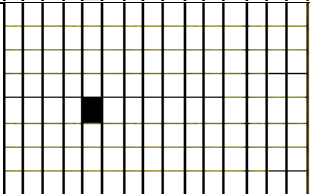
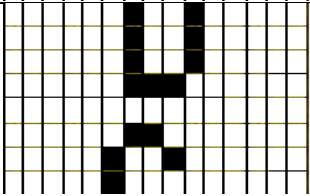
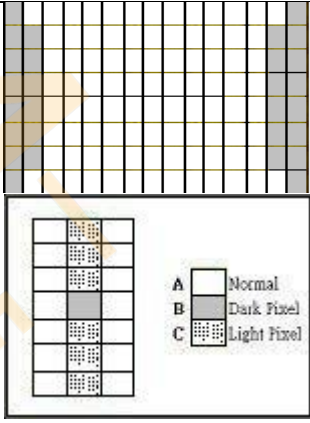

NO	Item	Criterion	AQL
11	Soldering	11.1 No un-melted solder paste may be present on the PCB. 11.2 No cold solder joints, missing solder connections, oxidation or icicle. 11.3 No residue or solder balls on PCB. 11.4 No short circuits in components on PCB.	2.5 2.5 2.5 0.65
12	General appearance	12.1 No oxidation, contamination, curves or, bends on interface Pin (OLB) of TCP. 12.2 No cracks on interface pin (OLB) of TCP. 12.3 No contamination, solder residue or solder balls on product. 12.4 The IC on the TCP may not be damaged, circuits. 12.5 The uppermost edge of the protective strip on the interface pin must be present or look as if it cause the interface pin to sever. 12.6 The residual rosin or tin oil of soldering (component or chip component) is not burned into brown or black color. 12.7 Sealant on top of the ITO circuit has not hardened. 12.8 Pin type must match type in specification sheet. 12.9 OLED pin loose or missing pins. 12.10 Product packaging must the same as specified on packaging specification sheet. 12.11 Product dimension and structure must conform to product specification sheet.	2.5 0.65 2.5 2.5 2.5 2.5 0.65 0.65 0.65 0.65

Check Item	Classification	Criteria
No Display	Major	
Missing Line	Major	
Pixel Short	Major	
Darker Short	Major	
Wrong Display	Major	
Un-uniform $B/A \times 100\% < 70\%$ $A/C \times 100\% < 70\%$	Major	

11. Precautions in use of OLED Modules

Modules

- (1) Avoid applying excessive shocks to module or making any alterations or modifications to it.
- (2) Don't make extra holes on the printed circuit board, change the components or modify its shape of OLED display module.
- (3) Don't disassemble the OLED display module.
- (4) Do not apply input signals while the logic power is off.
- (5) Don't operate it above the absolute maximum rating.
- (6) Don't drop, bend or twist OLED display module.
- (7) Soldering: only to the I/O terminals.
- (8) Hot-Bar FPC soldering condition: 280~350C, less than 5 seconds.
- (9) Winstar has the right to change the passive components (Resistors, capacitors and other passive components will have different appearance and color caused by the different supplier.) and change the PCB Rev. (In order to satisfy the supplying stability, management optimization and the best product performance...etc, under the premise of not affecting the electrical characteristics and external dimensions, Winstar have the right to modify the version.)
- (10) Winstar has the right to upgrade or modify the product function.
- (11) For COG & COF structure OLED products, customers should reserve VCC (VPP) adjustment function or software update function when designing OLED supporting circuit. (The progress of OLED light-emitting materials will increase the conversion efficiency and the brightness. The brightness can be adjusted if necessary).

11.1. Handling Precautions

- (1) Since the display panel is being made of glass, do not apply mechanical impacts such as dropping from a high position.
- (2) If the display panel is broken by some accident and the internal organic substance leaks out, be careful not to inhale nor lick the organic substance.
- (3) If pressure is applied to the display surface or its neighborhood of the OLED display module, the cell structure may be damaged. So, be careful not to apply pressure to these sections.
- (4) The polarizer covering the surface of the OLED display module is soft and easily scratched.
- (5) When the surface of the polarizer of the OLED display module has soil, clean the surface. It takes advantage by using following adhesion tape.
 - * Scotch Mending Tape No. 810 or an equivalentNever try to breathe upon the soiled surface nor wipe the surface using cloth containing solvent such as ethyl alcohol, since the surface of the polarizer will become cloudy. Also, pay attention that the following liquid and solvent may spoil the polarizer:
 - * Water
 - * Ketone
 - * Aromatic Solvents
- (6) Protection film is being applied to the surface of the display panel and removes the protection film before assembling it. At this time, if the OLED display module has been stored for a long period of time, residue adhesive material of the protection film may remain on the surface of the display panel after removed of the film. In such case, remove the residue material by the method introduced in the above Section 5.
- (7) Do not touch the following sections whenever possible while handling the OLED display modules.
 - * Pins and electrodes

* Pattern layouts such as the TCP & FPC

- (8) Hold OLED display module very carefully when placing OLED display module into the System housing. Do not apply excessive stress or pressure to OLED display module. And, do not over bend the film with electrode pattern layouts. These stresses will influence the display performance. Also, secure sufficient rigidity for the outer cases.

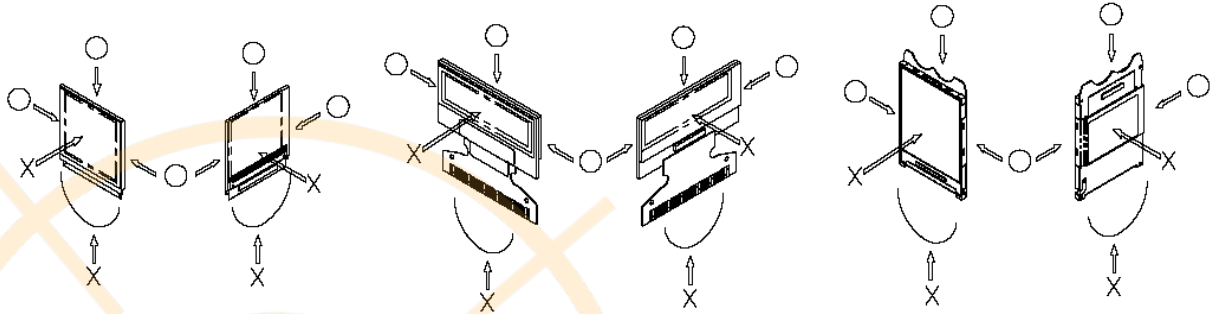

- (9) Do not apply stress to the LSI chips and the surrounding molded sections.
- (10) Pay sufficient attention to the working environments when handing OLED display modules to prevent occurrence of element breakage accidents by static electricity.
- * Be sure to make human body grounding when handling OLED display modules.
 - * Be sure to ground tools to use or assembly such as soldering irons.
 - * To suppress generation of static electricity, avoid carrying out assembly work under dry environments.
 - * Protective film is being applied to the surface of the display panel of the OLED display module. Be careful since static electricity may be generated when exfoliating the protective film.

11.2. Storage Precautions

- (1) When storing OLED display modules, put them in static electricity preventive bags to avoid be directly exposed to sun or lights of fluorescent lamps. And, also, place in the temperature $25\pm 5^{\circ}\text{C}$ and Humidity below 65% RH. (We recommend you to store these modules in the packaged state when they were shipped from Winstar. At that time, be careful not to let water drops adhere to the packages or bags.)
- (2) When the OLED display module is being dewed or when it is placed under high temperature or high humidity environments, the electrodes may be corroded if electric current is applied. Please store it in clean environment.

11.3. Designing Precautions

- (1) The absolute maximum ratings are the ratings which cannot be exceeded for OLED display module, and if these values are exceeded, OLED display module may be damaged.
- (2) To prevent occurrence of malfunctioning by noise, pay attention to satisfy the VIL and VIH specification and to make the signal line cable as short as possible.
- (3) We recommend you to install excess current preventive unit (fuses, etc.) to the power circuit (VDD / VCC). (Recommend value: 0.5A)
- (4) Pay sufficient attention to avoid occurrence of mutual noise interference with the nearby devices.
- (5) As for EMI, take necessary measures on the equipment side basically.
- (6) If the power supplied to the OLED display module is forcibly shut down by such errors as taking out the main battery while the OLED display panel is in operation, we cannot guarantee the quality of this OLED display module.
- * Connection (contact) to any other potential than the above may lead to rupture of the IC.

- (7) If this OLED driver is exposed to light, malfunctioning may occur and semiconductor elements may change their characteristics.
- (8) The internal status may be changed, if excessive external noise enters into the module. Therefore, it is necessary to take appropriate measures to suppress noise generation or to protect module from influences of noise on the system design.
- (9) We recommend you to make periodical refreshment of the operation statuses (re-setting of the commands and re-transference of the display data) to cope with catastrophic noise.
- (10) It's pretty common to use "Screen Saver" to extend the lifetime and Don't use the same image for long time in real application. When an OLED display module is operated for a long of time with fixed pattern, an afterimage or slight contrast deviation may occur.
- (11) The limitation of FPC and Film bending.

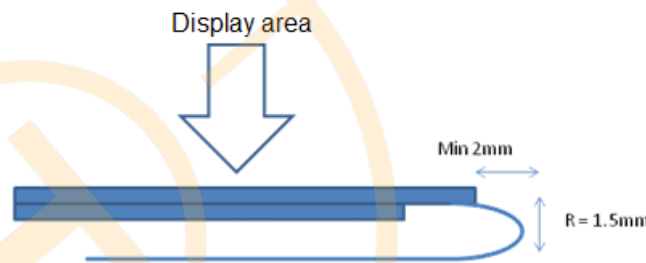

- (12) The module should be fixed balanced into the housing, or the module may be twisted.

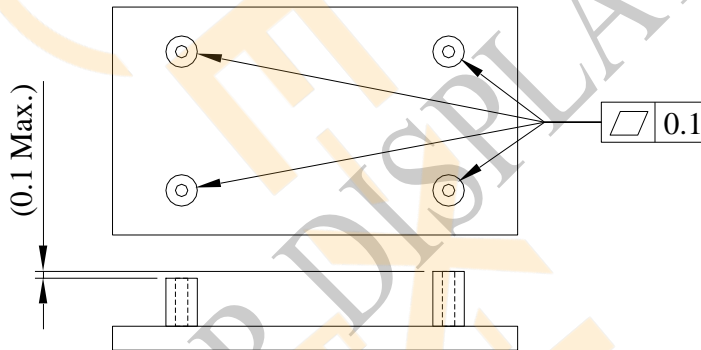

- (13) Please heat up a little the tape sticking on the components when removing it; otherwise the components might be damaged.

11.4. Precautions when disposing of the OLED display modules

- (1) Request the qualified companies to handle industrial wastes when disposing of the OLED display modules. Or, when burning them, be sure to observe the environmental and hygienic laws and regulations.

The Netherlands



Elektrostraat 17
NL-7483 PG Haaksbergen

T: +31 (0)53 573 33 33
F: +31 (0)53 573 33 30
E: nl@texim-europe.com

Belgium



Zuiderlaan 14 bus 10
B-1731 Zellik

T: +32 (0)2 462 01 00
F: +32 (0)2 462 01 25
E: belgium@texim-europe.com

UK & Ireland



St. Mary's House, Church Lane
Carlton Le Moorland
Lincoln LN5 9HS

T: +44 (0)1522 789 555
F: +44 (0)845 299 22 26
E: uk@texim-europe.com

Germany North



Bahnhofstrasse 92
D-25451 Quickborn

T: +49 (0)4106 627 07-0
F: +49 (0)4106 627 07-20
E: germany@texim-europe.com

Germany South



Martin-Kollar-Strasse 9
D-81829 München

T: +49 (0)89 436 086-0
F: +49 (0)89 436 086-19
E: germany@texim-europe.com

Austria



Warwitzstrasse 9
A-5020 Salzburg

T: +43 (0)662 216 026
F: +43 (0)662 216 026-66
E: austria@texim-europe.com

Nordic region



Sdr. Jagtvej 12
DK-2970 Hørsholm

T: +45 88 20 26 30
F: +45 88 20 26 39
E: nordic@texim-europe.com

Italy



Via Matteotti 43
IT-20864 Agrate Brianza (MB)

T: +39 (0)39 971 3293
F: +39 (0)39 971 3293
E: italy@texim-europe.com

General information



info@texim-europe.com
www.texim-europe.com