

Left, locking screw flanges
CVF_OS1 - 2 ÷ 8 poles, 5 mm / .197" pitch
CVF_OS2 - 2 ÷ 4 poles, 10 mm / .394" pitch
CVF_OS5 - 2 ÷ 23 poles, 5.08 mm / .200" pitch
CVF_OS7 - 2 ÷ 12 poles, 7.62 mm / .300" pitch
CVF_OS6 - 2 ÷ 12 poles, 10.16 mm / .400" pitch

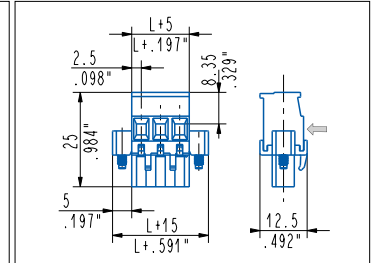

Right, locking screw flanges
CVF_OD1 - 2 ÷ 8 poles, 5 mm / .197" pitch
CVF_OD2 - 2 ÷ 4 poles, 10 mm / .394" pitch
CVF_OD5 - 2 ÷ 23 poles, 5.08 mm / .200" pitch
CVF_OD7 - 2 ÷ 12 poles, 7.62 mm / .300" pitch
CVF_OD6 - 2 ÷ 12 poles, 10.16 mm / .400" pitch

General data

Dimensional class: medium
Standard colour: green
Pitches: metric 5 mm, 7.5 mm, 10 mm (.197 in, .295 in, .394 in)
 imperial 5.08, 7.62, 10.16 mm (.200, .300, .400 in)
Screw dimension: M3
Recommended/Highest tightening torque: 0.5/0.6 Nm (4.42/5.3 lbf-in)
Stripping length: 6 ÷ 7.5 mm (.24 ÷ .30 in)
Operating temperature range: -40 °C ÷ +105 °C (-40 °F ÷ +221 °F)
Contact resistance: <15 mΩ
Insulating material group: I (CTI ≥ 600V)
Self-extinguishing class UL94: V0
Insulation resistance: >10⁹ Ω (500V DC)

Certifications

UL (n. E167473)
 300 V - 15 A - 30÷12 AWG - for 5 mm, 5.08 mm, 7.5 mm and 7.62 mm pitch
 600 V - 15 A - 30÷12 AWG - for 10 mm and 10.16 mm pitch

VDE (n. 40027448)
 250 V - 16 A - 2.5 mm² - for 5 mm and 5.08 mm pitch
 500 V - 16 A - 2.5 mm² - for 7.5 mm and 7.62 mm pitch
 750 V - 16 A - 2.5 mm² - for 10 mm and 10.16 mm pitch

IMQ (n. EM672)
 300 V - 12 A - 2.5 mm² - 2.5 mm² for 5 mm and 5.08 mm pitch
 1000 V - 12 A - 2.5 mm² - 2.5 mm² for 10 mm, 7.5 mm, 7.62 and 10.16 mm pitch

CSA (n. LR102896)
 300 V - 15 A - 30÷12 AWG for 5 mm, 5.08 mm, 7.5 mm and 7.62 mm pitch
 600 V - 15 A - 30÷12 AWG for 10 mm and 10.16 mm pitch

Application values for end-use equipment have to be in accordance to norms and applicable to it.
 The certifications of some product's versions could be pending, for more detailed and updated data please refer to our web site www.sauro.net or your representative Sales Manager.

A higher number of poles is obtained by combining together modular parts.

Please see "CONNECTORS COMBINATIONS"

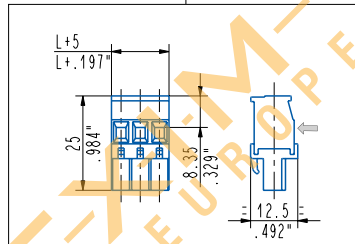
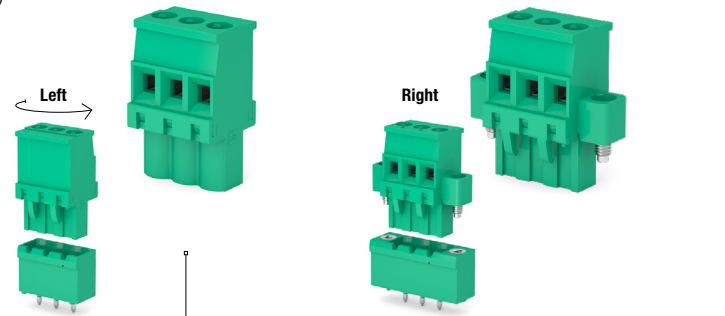

Left, side stackable
CVF_OL1 - 2 ÷ 25 poles, 5 mm / .197" pitch
CVF_OL3 - 2 ÷ 12 poles, 7.5 mm / .295" pitch
CVF_OL2 - 2 ÷ 13 poles, 10 mm / .394" pitch
CVF_OL5 - 2 ÷ 25 poles, 5.08 mm / .200" pitch
CVF_OL7 - 2 ÷ 12 poles, 7.62 mm / .300" pitch
CVF_OL6 - 2 ÷ 13 poles, 10.16 mm / .400" pitch

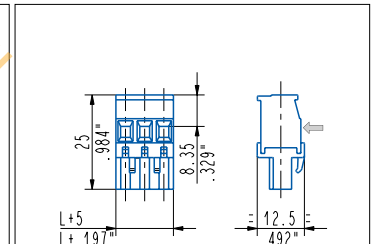

Right, side stackable
CVF_OR1 - 2 ÷ 25 poles, 5 mm / .197" pitch
CVF_OR3 - 2 ÷ 12 poles, 7.5 mm / .295" pitch
CVF_OR2 - 2 ÷ 13 poles, 10 mm / .394" pitch
CVF_OR5 - 2 ÷ 25 poles, 5.08 mm / .200" pitch
CVF_OR7 - 2 ÷ 12 poles, 7.62 mm / .300" pitch
CVF_OR6 - 2 ÷ 13 poles, 10.16 mm / .400" pitch

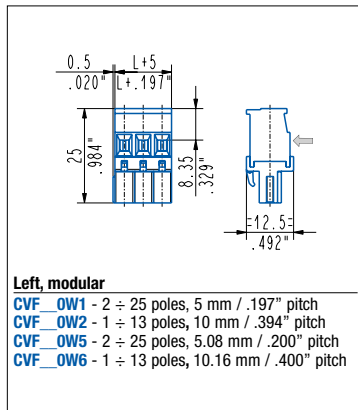

Left, modular
CVF_OW1 - 2 ÷ 25 poles, 5 mm / .197" pitch
CVF_OW2 - 1 ÷ 13 poles, 10 mm / .394" pitch
CVF_OW5 - 2 ÷ 25 poles, 5.08 mm / .200" pitch
CVF_OW6 - 1 ÷ 13 poles, 10.16 mm / .400" pitch

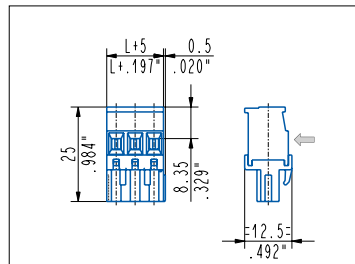

Right, modular
CVF_OM1 - 2 ÷ 25 poles, 5 mm / .197" pitch
CVF_OM2 - 1 ÷ 13 poles, 10 mm / .394" pitch
CVF_OM5 - 2 ÷ 25 poles, 5.08 mm / .200" pitch
CVF_OM6 - 1 ÷ 13 poles, 10.16 mm / .400" pitch

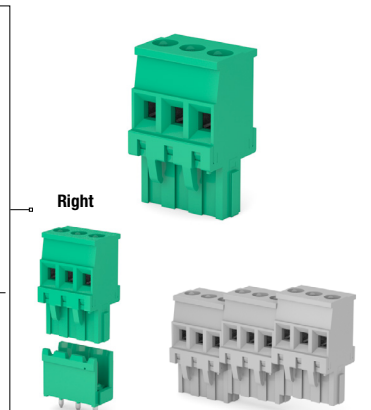

Usable with:

CIM Page 68	CIMH Page 70	CPM high Page 72	CPM/CPMH Page 73	CRM Page 74	CIMH normo Page 75	CGM Page 76	CIF-LC1 Page 80
-----------------------	------------------------	----------------------------	----------------------------	-----------------------	------------------------------	-----------------------	---------------------------

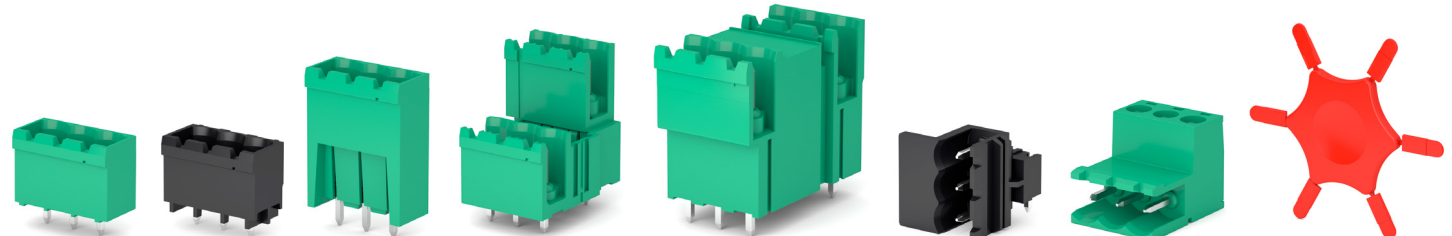



Headquarters & Warehouse

Elektrostraat 17
NL-7483 PG Haaksbergen
The Netherlands

T: +31 (0)53 573 33 33
E: info@texim-europe.com
Homepage: www.texim-europe.com



The Netherlands

Elektrostraat 17
NL-7483 PG Haaksbergen

T: +31 (0)53 573 33 33
E: nl@texim-europe.com



Belgium

Zuiderlaan 14, box 10
B-1731 Zellik

T: +32 (0)2 462 01 00
E: belgium@texim-europe.com



UK & Ireland

St Mary's House, Church Lane
Carlton Le Moorland
Lincoln LN5 9HS

T: +44 (0)1522 789 555
E: uk@texim-europe.com



Germany - North

Bahnhofstrasse 92
D-25451 Quickborn

T: +49 (0)4106 627 07-0
E: germany@texim-europe.com



Germany - South

Martin-Kollar-Strasse 9
D-81829 München

T: +49 (0)89 436 086-0
E: muenchen@texim-europe.com



Austria

Warwitzstrasse 9
A-5020 Salzburg

T: +43 (0)662 216 026
E: austria@texim-europe.com



Nordic

Søndre Jagtvej 12
DK-2970 Hørsholm

T: +45 88 20 26 30
E: nordic@texim-europe.com



Italy

Via Matteotti 43
IT-20864 Agrate Brianza (MB)

T: +39 (0)39 9713293
E: italy@texim-europe.com