

PRODUCT DATA SHEET

RRC-MC21-90-20

RRC-MC21-90-20

Battery Mating Connector

P/N: 211278

Distributed by:



www.texim-europe.com

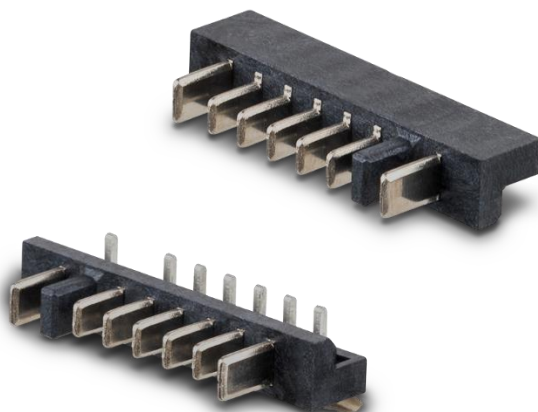

Features:

- Mating connector for standard battery form factors RRC21xx
- 7.00A max. charge or discharge current to battery
- 7-pin male connector
- 2.5mm pitch
- RoHS and REACH compliant

Applications:

Mating connector for RRC's smart batteries used in medical and industrial applications

PRODUCT DATA SHEET

RRC-MC21-90-20

Specification

Ratings	
Current	7.00A max. / pin
Voltage	30.00VDC
Materials	
Housing	Thermoplastic High Temperature, UL 94 V-0, black
Contacts	Copper Alloy
Plating	50µin Nickel on contact area, 100µin Matte-Tin on solder tails
Environmental Condition	
Operating Temperature	-40°C to +105°C
Electrical Requirements	
Contact Resistance	40mOhm max.
Insulation Resistance	100MOhm min. at 500.00VDC / 1min
Dielectric withstand	500.00VAC / 1min
Mechanical Requirements	
Dimensions (LxWxH)	24.50mm x 9.50mm x 4.50mm
Weight	Typical 1g
PCB mounting	90° PCB edge mounting
Contact Retention Force	300g min. / pin
Physical Requirements	
Solder Temperature	260°C ± 5°C
Immersion Period	5sec (EIA-364-56C)
Regulatory Approvals	
Green Procurement	RoHS REACH
Packaging	
24 connectors per tube	
200 tubes per carton	

PRODUCT DATA SHEET

RRC-MC21-90-20

Drawings

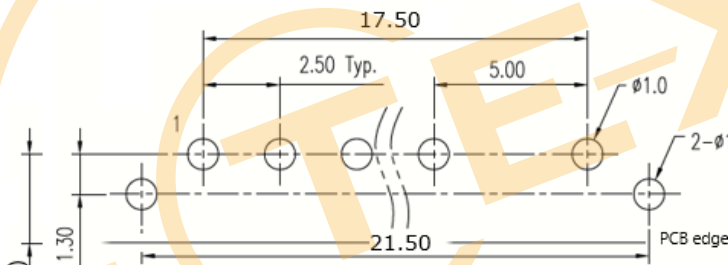
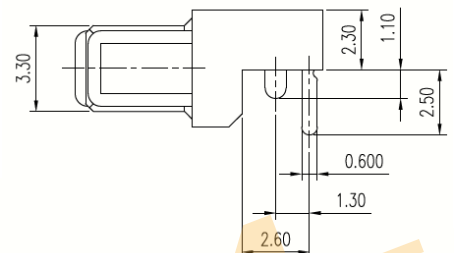
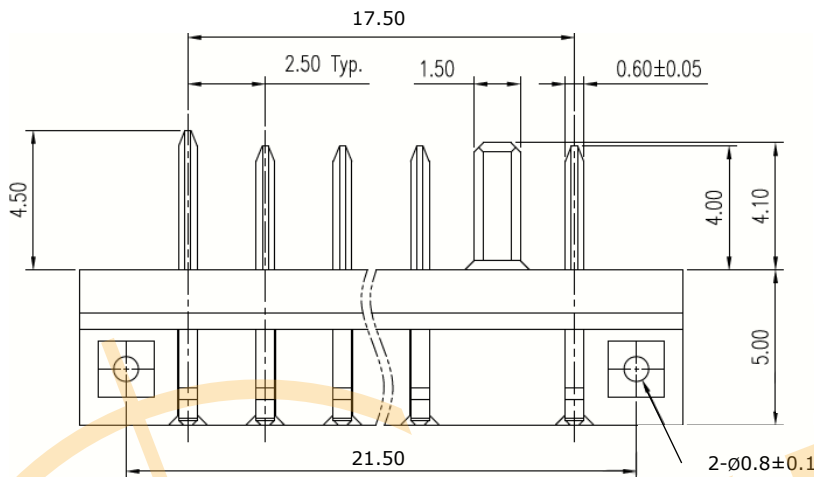
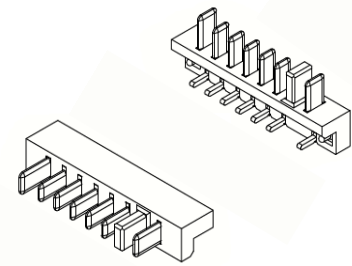
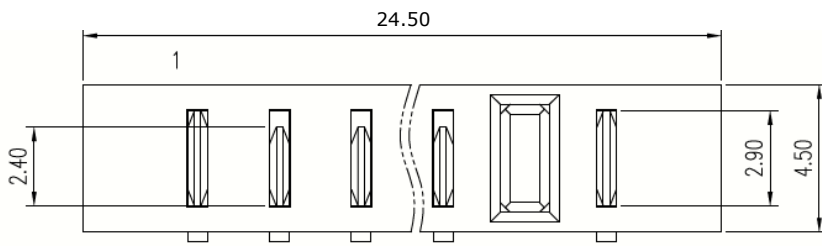

Recommended P.C.B. Layout
Layout Tolerance = ± 0.05mm

DIMENSION IN mm	
Tolerance unless otherwise specified	
X.	X.* ± 10'
X.X ± 0.38	X.X* ± 5'
X.XX ± 0.25	X.XX* ± 2'
X.XXX ± 0.13	X.XXX*

Germany/Headquarters

RRC power solutions GmbH
Technologiepark 1
66424 Homburg / Saar

Tel.: +49 6841 98090
Fax: +49 6841 9809280
Email: sales@rrc-ps.com
Web: www.rrc-ps.com

USA

RRC power solutions Inc.
18340 Yorba Linda Blvd.,
107-437
Yorba Linda, CA 92886

Tel.: +1 714 777 3604
Fax: +1 714 777 3658
Email: usa@rrc-ps.com
Web: www.rrc-ps.com

Hong Kong

RRC power solutions Ltd.
S-V,6/F, Valiant Industrial
Centre 2-12 Au Pui Wan Street
Fo Tan, N.T., Hong Kong

Tel.: +852 2376 0106
Fax: +852 2375 0107
Email: hkrcc@rrc-ps.cn
Web: www.rrc-ps.cn

China

RRC power solutions Ltd.
Room 1306, C Building,
Tianan International building,
Renmin South Road, Luohu
District, Shenzhen 518021

Tel.: +86 755 8374 1908
Fax: +86 755 8374 1861
Email: hkrcc@rrc-ps.cn
Web: www.rrc-ps.cn

Disclaimer

ALL PRODUCTS, PRODUCT SPECIFICATIONS AND DATA ARE SUBJECT TO CHANGE WITHOUT NOTICE TO IMPROVE RELIABILITY, FUNCTION OR DESIGN OR OTHERWISE.

Texim Europe B.V. its affiliates, agents, and employees, and all persons acting on its or their behalf (collectively, "Texim"), disclaim any and all liability for any errors, inaccuracies or incompleteness contained in any datasheet or in any other disclosure relating to any product.

Texim makes no warranty, representation or guarantee regarding the suitability of the products for any particular purpose or the continuing production of any product.

It is the customer's responsibility to validate that a particular product with the properties described in the product specification is suitable for use in a particular application.

Parameters provided in datasheets and / or specifications may vary in different applications and performance may vary over time.

All operating parameters, including typical parameters, must be validated for each customer application by the customer's technical experts.

Please contact us if you have any questions about the contents of the datasheet.

This may not be the latest version of the datasheet. Please check with us if a later version is available.

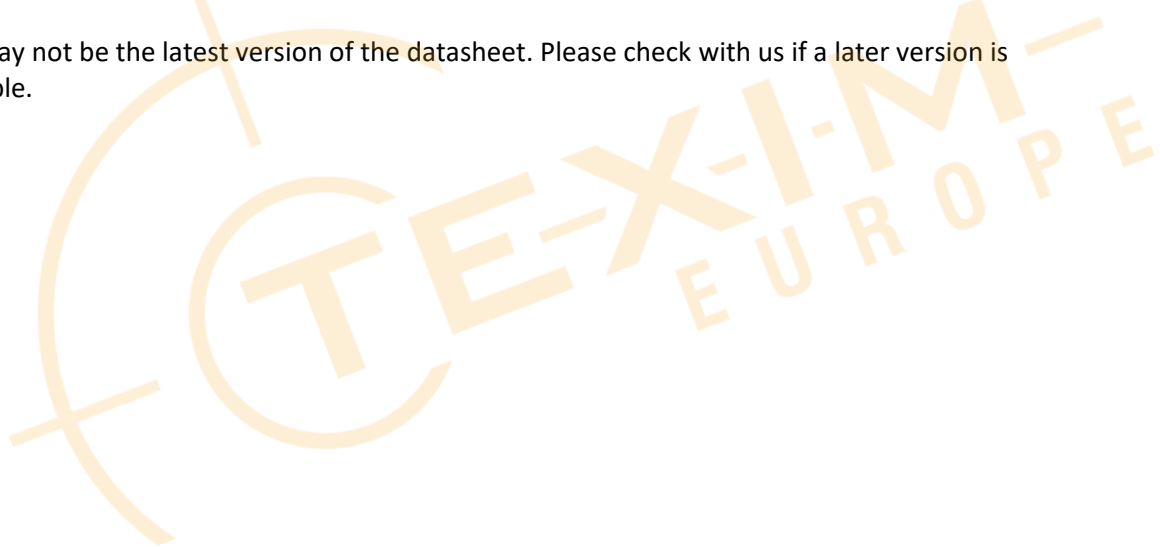



Headquarters & Warehouse

Elektrostraat 17
 NL-7483 PG Haaksbergen
 The Netherlands

T: +31 (0)53 573 33 33
 E: info@texim-europe.com
 Homepage: www.texim-europe.com



The Netherlands

Elektrostraat 17
 NL-7483 PG Haaksbergen

T: +31 (0)53 573 33 33
 E: nl@texim-europe.com



Belgium

Zuiderlaan 14, box 10
 B-1731 Zellik

T: +32 (0)2 462 01 00
 E: belgium@texim-europe.com



UK & Ireland

St Mary's House, Church Lane
 Carlton Le Moorland
 Lincoln LN5 9HS

T: +44 (0)1522 789 555
 E: uk@texim-europe.com



Germany - North

Bahnhofstrasse 92
 D-25451 Quickborn

T: +49 (0)4106 627 07-0
 E: germany@texim-europe.com



Germany - South

Martin-Kollar-Strasse 9
 D-81829 München

T: +49 (0)89 436 086-0
 E: muenchen@texim-europe.com



Austria

Warwitzstrasse 9
 A-5020 Salzburg

T: +43 (0)662 216 026
 E: austria@texim-europe.com



Nordic

Søndre Jagtvej 12
 DK-2970 Hørsholm

T: +45 88 20 26 30
 E: nordic@texim-europe.com



Italy

Martin-Kollar-Strasse 9
 D-81829 München

T: +49 (0)89 436 086-0
 E: italy@texim-europe.com