

Distributed by:



TFT DISPLAY SPECIFICATION



WINSTAR Display Co.,Ltd.
華凌光電股份有限公司



Winstar Display Co., LTD

華凌光電股份有限公司

WEB: <https://www.winstar.com.tw> E-mail: sales@winstar.com.tw



SPECIFICATION

CUSTOMER : _____

MODULE NO.: WF57A5TYAFDNT0#

<p>APPROVED BY: (FOR CUSTOMER USE ONLY)</p>	<p>PCB VERSION: _____ DATA: _____</p>
--	---

SALES BY	APPROVED BY	CHECKED BY	PREPARED BY
			葉虹蘭
ISSUED DATE: 2024/03/13			

TFT Display Inspection Specification: <https://www.winstar.com.tw/technology/download.html>

Precaution in use of TFT module: <https://www.winstar.com.tw/technology/download/declaration.html>

RECORDS OF REVISION

DOC. FIRST ISSUE

VERSION	DATE	REVISED PAGE NO.	SUMMARY
0	2023/12/28		First issue
A	2024/02/29		Modify TP and LCD type (Normally black)
B	2024/03/13		Modify Static electricity test



Contents

- 1.Module Classification Information
- 2.Summary
- 3.General Specifications
- 4.Absolute Maximum Ratings
- 5.Electrical Characteristics
- 6.Timing Characteristics
- 7.Power Sequence
- 8.Optical Characteristics
- 9.Interface
- 10.Reliability
- 11.Touch Panel Information
- 12.Contour Drawing
- 13.Other

1.Module Classification Information

W F 57 A5 T Y A F D N T 0 #
 ① ② ③ ④ ⑤ ⑥ ⑦ ⑧ ⑨ ⑩ ⑪ ⑫ ⑬

①	Brand : WINSTAR DISPLAY CORPORATION											
②	Display Type : F→TFT Type, J→Custom TFT											
③	Display Size : 5.7" TFT											
④	Model serials no.											
⑤	Backlight Type :	F→CCFL, White S→LED, High Light White				T→LED, White Z→Nichia LED, White						
⑥	LCD Polarize Type/ Temperature range/ Gray Scale Inversion Direction	A→Transmissive, N.T, IPS TFT C→Transmissive, N. T, 6:00 ; F→Transmissive, N.T,12:00 ; I→Transmissive, W. T, 6:00 K→Transflective, W.T,12:00 L→Transmissive, W.T,12:00 N→Transmissive, Super W.T, 6:00				Q→Transmissive, Super W.T, 12:00 R→Transmissive, Super W.T, O-TFT V→Transmissive, Super W.T, VA TFT W→Transmissive, Super W.T, IPS TFT X→Transmissive, W.T, VA TFT Y→Transmissive, W.T, IPS TFT Z→Transmissive, W.T, O-TFT						
⑦	A : TFT LCD B : TFT+SCREW HOLES+CONTROL BOARD C : TFT+ SCREW HOLES +A/D BOARD D : TFT+ SCREW HOLES +A/D BOARD+CONTROL BOARD E : TFT+ SCREW HOLES +POWER BOARD				F : TFT+CONTROL BOARD G : TFT+ SCREW HOLES H : TFT+D/V BOARD I : TFT+ SCREW HOLES +D/V BOARD J : TFT+POWER BD							
⑧	Resolution:											
	A	128160	B	320234	C	320240	D	480234	E	480272	F	640480
	G	800480	H	1024600	I	320480	J	240320	K	800600	L	240400
	M	1024768	N	128128	P	1280800	Q	480800	R	640320	S	480128
	T	800320	U	8001280	V	176220	W	1280398	X	1024250	Y	1920720
	Z	800200	2	1024324	3	7201280	4	19201200	5	1366768	6	1280320
⑨	D: Digital L : LVDS M:MIPI											
⑩	Interface:											
	N	Without control board			A	8Bit		B	16Bit		H	HDMI
	I	I2C Interface			R	RS232		S	SPI Interface		U	USB
⑪	TS:											
	N	Without TS			T	Resistive touch panel			C	Capacitive touch panel (G-F-F)		
	G	Capacitive touch panel (G-G)					C1	Capacitive touch panel (G-F-F)+OCA				
	C2	Capacitive touch panel (G-F-F)+OCR					G1	Capacitive touch panel (G-G)+OCA				
	G2	Capacitive touch panel (G-G)+OCR					B	CTP+GG+USB				
⑫	Version: X:Raspberry pi											
⑬	Special Code	#:Fit in with ROHS directive regulations										

2.Summary

TFT 5.7" is a TFT-LCD module. It is composed of a TFT-LCD panel, driver IC ,FPC, a backlight unit. The 5.7 display area contains 640 x 480pixels and can display up to 16.7M colors. This product accords with RoHS environmental criterion.



3. General Specifications

Item	Dimension	Unit
Size	5.7	inch
Dot Matrix	640 x RGBx480(TFT)	dots
Module dimension	124.7 x 100.0 x 7.41	mm
Active area	115.2 x 86.4	mm
Pixel pitch	0.18 x 0.18	mm
LCD type	TFT, Normally black, Transmissive	
View Angle	80/80/80/80	
TFT Driver IC	JD9168S or Equivalent	
TFT interface	RGB18bits SYNC+DE mode	
Aspect Ratio	4:3	
Backlight Type	LED ,Normally White	
With /Without TP	With RTP	
Surface	Anti-Glare	

*Color tone slight changed by temperature and driving voltage.

4. Absolute Maximum Ratings

Item	Symbol	Min	Typ	Max	Unit
Operating Temperature	TOP	-20	—	+70	°C
Storage Temperature	TST	-30	—	+80	°C

Note: Device is subject to be damaged permanently if stresses beyond those absolute maximum ratings listed above

1. Temp. 60°C, 90% RH MAX. Temp. > 60°C, Absolute humidity shall be less than 90% RH at 60°C



5. Electrical Characteristics

5.1. Operating conditions:

Parameter	Symbol	Condition	Min	Typ	Max	Unit	Note
Supply Voltage	VCC	Ta=25°C	3.0	3.3	3.6	V	
Input voltage	H	V _{IH}	VCC=3.0V	0.7VCC	-	VCC	
	L	V _{IL}	VCC=3.0V	0	-	0.3VCC	mW
Power supply Current (Operating)	ICC	VCC=3.0V	—	50	75	mA	1

Note1 ALL White Display pattern

5.2. LED driving conditions

Parameter	Symbol	Min.	Typ.	Max.	Unit	Remark
LED current	-	-	80	-	mA	-
Power Consumption	-	1344	1440	1536	mW	-
LED voltage	V _{LED+}	16.8	18.0	19.2	V	Note 1
LED Life Time	-	-	50,000	-	Hr	Note 2,3,4

Note 1 : There are 1 Groups LED

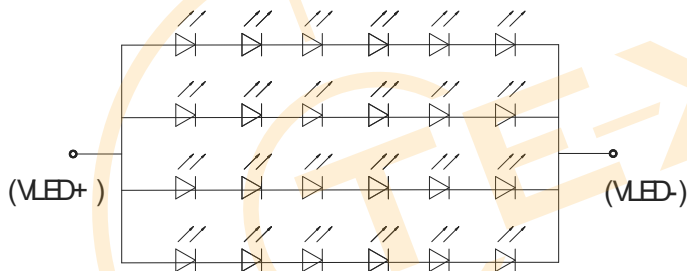

Back Light Circuit

Note 2 : Ta = 25 °C

Note 3 : Brightness to be decreased to 50% of the initial value

Note 4 : The single LED lamp case

6. Timing Characteristics

RGB Interface

Vertical Timings

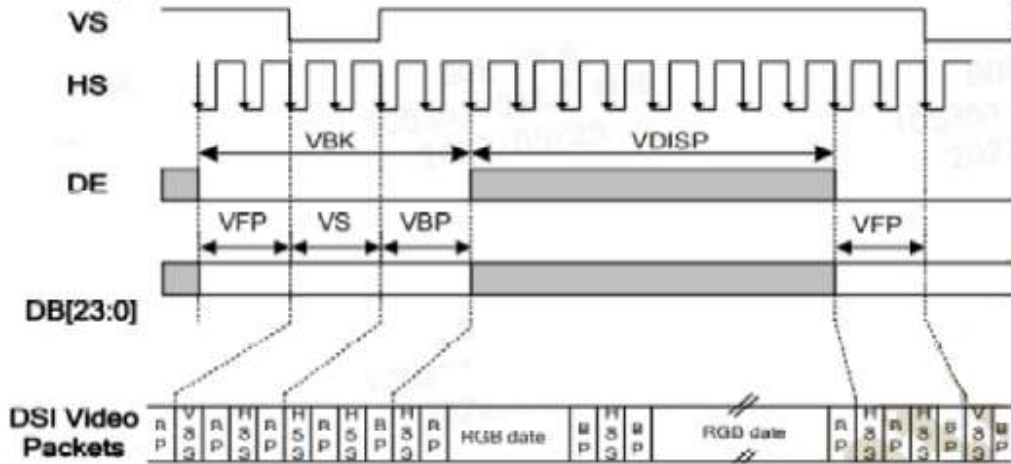

Horizontal Timings

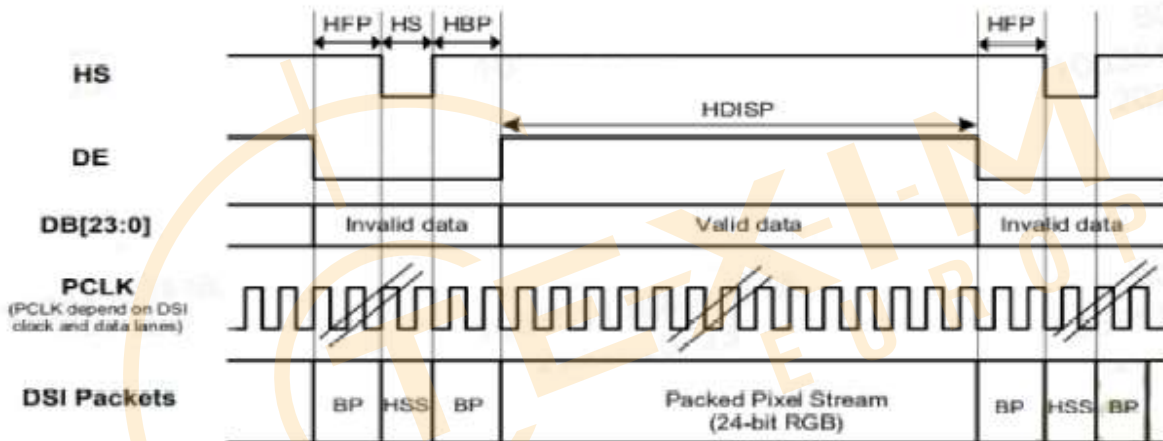

Signal	Item	Symbol	Min	Typ	Max	Unit	Note
PCLK	Frequency	Fc	18	20	27	MHZ	
Vertical Active Display Term	Total	Tv	501	518	535	Th	Tv=VDISP+VBK
	Display	VDISP		480		Th	
	Blank	VBK	21	38	55	Th	VBK=VS+VBP+VFP
Horizontal Active Display Term	Total	Th	652	664	700	Tc(*)	Th=HDISP+HBLK
	Display	HDISP		640		Tc(*)	
	Blank	HBLK	12	24	60	Tc(*)	HBLK=HS+HBP+HFP

Tc: PCLK cycle time.

7. Power Sequence

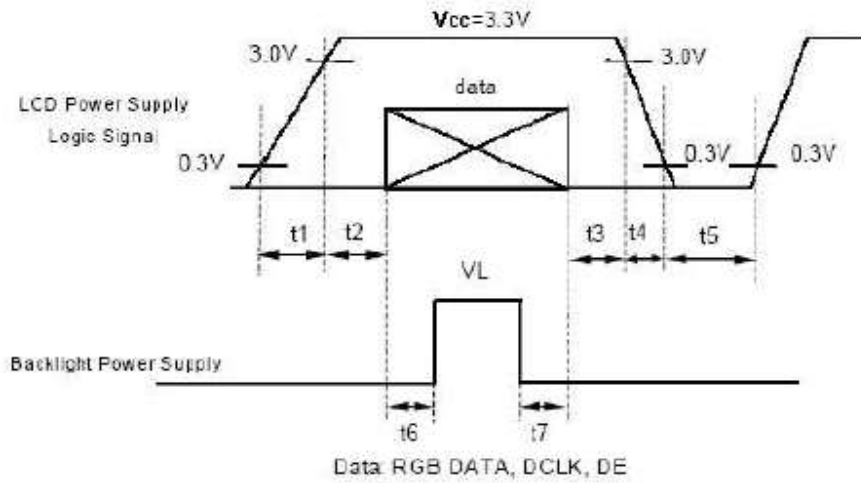

*2) VCC-dip condition:

(1) $2.7V \leq V_{CC} < 3.0V, t_d \leq 10ms$

(2) $V_{CC} > 3.0V, V_{CC}$ -dip condition should be the same with VCC-turn-on condition

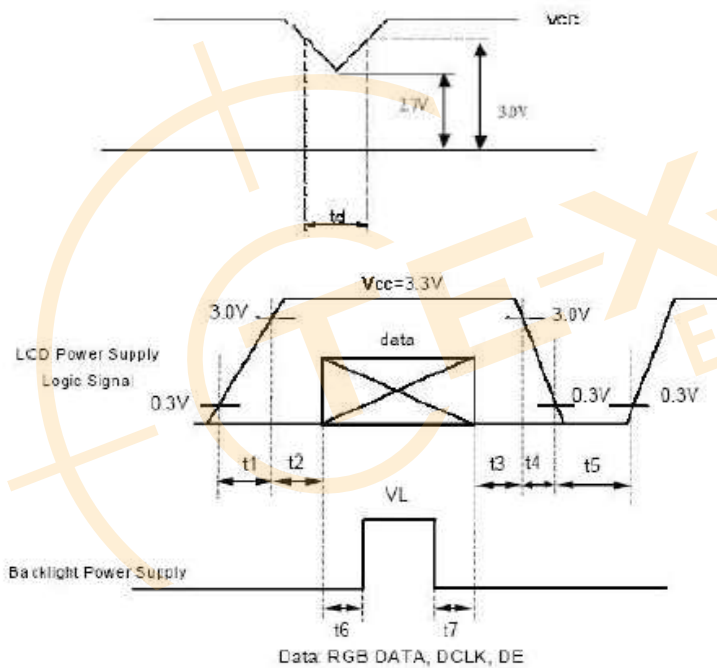

*2) VCC-dip condition:

(1) $2.7V \leq V_{CC} < 3.0V, t_d \leq 10ms$

(2) $V_{CC} > 3.0V, V_{CC}$ -dip condition should be the same with VCC-turn-on condition

$t_1 \leq 10ms$: $1 \text{ sec} \leq t_5$
 $50ms \leq t_2$: $200ms \leq t_6$
 $0 < t_3 \leq 50ms$: $200ms \leq t_7$
 $0 < t_4 \leq 10ms$

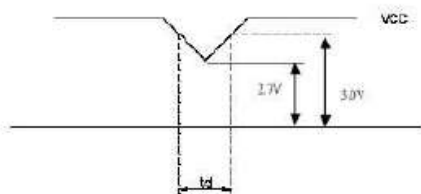

8. Optical Characteristics

Item	Symbol	Condition.	Min	Typ.	Max.	Unit	Remark	
Response time	Tr+ Tf	$\theta=0^\circ$ 、 $\Phi=0^\circ$	-	30	35	ms	Note 3	
Contrast ratio	CR	At optimized viewing angle	1000	1200	-	-	Note 4	
Color Chromaticity	White	Wx	$\theta=0^\circ$ 、 $\Phi=0^\circ$	0.242	0.292	0.342	-	Note 2,6,7
		Wy		0.287	0.337	0.387		
Viewing angle	Hor.	Θ_R	$CR \geq 10$	-	80	-	Deg.	Note 1
		Θ_L		-	80	-		
	Ver.	Φ_T		-	80	-		
		Φ_B		-	80	-		
Brightness	-	-	250	350	-	cd/m ²	Center of display	
Uniformity	(U)	-	70	-	-	%	Note5	

Ta=25±2°C, IL=80mA

Note 1: Definition of viewing angle range

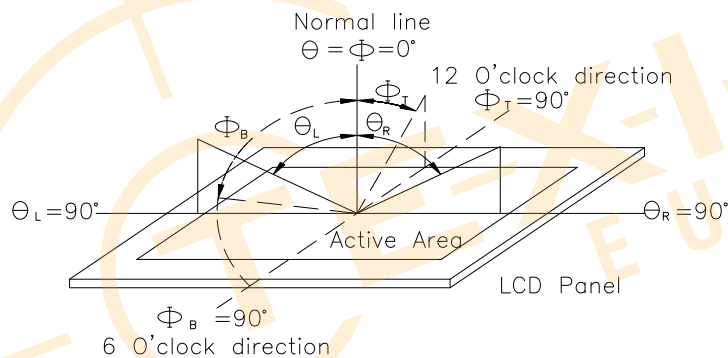

Fig.8.1. Definition of viewing angle

Note 2: Test equipment setup:

After stabilizing and leaving the panel alone at a driven temperature for 10 minutes, the measurement should be executed. Measurement should be executed in a stable, windless, and dark room. Optical specifications are measured by Topcon BM-7 or BM-5 luminance meter 1.0° field of view at a distance of 50cm and normal direction.

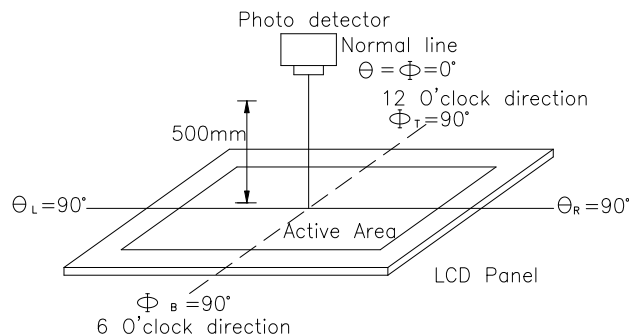
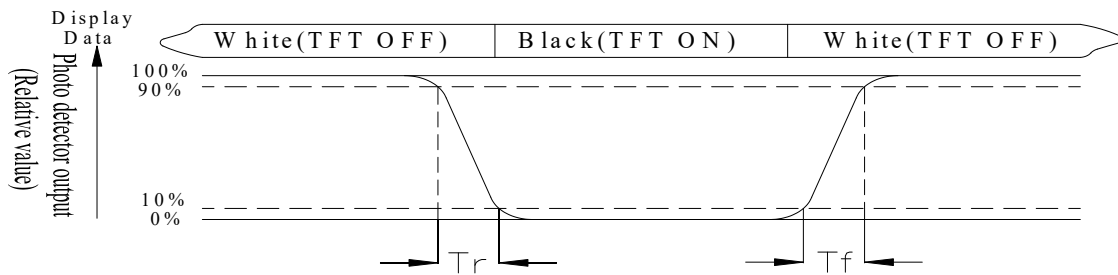

Fig. 8.2. Optical measurement system setup

Note 3: Definition of Response time:

The response time is defined as the LCD optical switching time interval between “White” state and “Black” state. Rise time, T_r , is the time between photo detector output intensity changed from 90% to 10%. And fall time, T_f , is the time between photo detector output intensity changed from 10% to 90%



Note 4: Definition of contrast ratio:

The contrast ratio is defined as the following expression.

$$\text{Contrast ratio (CR)} = \frac{\text{Luminance measured when LCD on the "White" state}}{\text{Luminance measured when LCD on the "Black" state}}$$

Note 5: Definition of Luminance Uniformity

Active area is divided into 9 measuring areas (reference the picture in below). Every measuring point is placed at the center of each measuring area.

Luminance Uniformity (U) = $L_{\min}/L_{\max} \times 100\%$

L = Active area length

W = Active area width

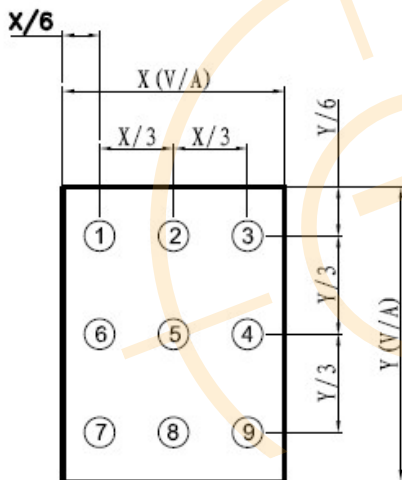

Fig8.3. . Definition of uniformity

Note 6: Definition of color chromaticity (CIE 1931)

Color coordinates measured at the center point of LCD

Note 7: Measured at the center area of the panel when all the input terminals of LCD panel are electrically opened.

9.Interface

9.1. LCM PIN Definition

Pin	Symbol	I/O	Function	Remark
1	GND	P	Ground.	
2	VCC	P	Power supply for TFT	
3	VCC	P	Power supply for TFT	
4	GND	P	Ground.	
5	NC	-	No connection	
6	GND	P	Ground.	
7	NC	-	No connection	
8	GND	P	Ground.	
9	UD	I	Up/down selection	
10	LR	I	Left /right selection	
11	/CSX	I	Chip select pin. 0: Chip can be accessed; 1: Chip cannot be accessed. If this pin is not used, please connect it to VCC.	
12	SCL	I	Serial clock input in SPI interface .If not use, let it open or VCC or GND.	
13	SDA	I	Serial data input / output pin in SPI interface operation. If not use, let it open.	
14	NC	-	No connection	
15	GND	P	Ground.	
16	B5	I	Blue Data bus	
17	B4	I	Blue Data bus	
18	B3	I	Blue Data bus	
19	B2	I	Blue Data bus	
20	B1	I	Blue Data bus	
21	B0	I	Blue Data bus	
22	NC	-	No connection	
23	NC	-	No connection	
24	GND	P	Ground.	
25	G5	I	Green Data bit	
26	G4	I	Green Data bit	
27	G3	I	Green Data bit	
28	G2	I	Green Data bit	
29	G1	I	Green Data bit	

30	G0	I	Green Data bit	
31	NC	-	No connection	
32	NC	-	No connection	
33	GND	P	Ground.	
34	NC	-	No connection	
35	NC	-	No connection	
36	GND	P	Ground.	
37	R5	I	Red Data bit	
38	R4	I	Red Data bit	
39	R3	I	Red Data bit	
40	R2	I	Red Data bit	
41	R1	I	Red Data bit	
42	R0	I	Red Data bit	
43	VLED-	P	Power supply for LED cathode	
44	VLED+	P	Power supply for LED anode	
45	DE	I	Data enable input in RGB interface.	
46	CLK	I	Pixel clock input in RGB interface.	
47	HS	I	Horizontal sync input in RGB interface.	
48	VS	I	Vertical sync input in RGB interface	
49	NC	-	No connection	
50	GND	P	Ground.	

10. Reliability

Content of Reliability Test (Wide temperature, -20°C~70°C)

Environmental Test			
Test Item	Content of Test	Test Condition	Note
High Temperature storage	Endurance test applying the high storage temperature for a long time.	80°C 200hrs	2
Low Temperature storage	Endurance test applying the low storage temperature for a long time.	-30°C 200hrs	1,2
High Temperature Operation	Endurance test applying the electric stress (Voltage & Current) and the thermal stress to the element for a long time.	70°C 200hrs	—
Low Temperature Operation	Endurance test applying the electric stress under low temperature for a long time.	-20°C 200hrs	1
High Temperature/ Humidity Operation	The module should be allowed to stand at 60°C,90%RH max	60°C,90%RH 96hrs	1,2
Thermal shock resistance	<p>The sample should be allowed stand the following 10 cycles of operation</p> <p style="text-align: center;">-20°C 25°C 70°C</p> <p style="text-align: center;">30min 5min 30min</p> <p style="text-align: center;">1 cycle</p>	-20°C/70°C 10 cycles	—
Vibration test	Endurance test applying the vibration during transportation and using.	Total fixed amplitude : 1.5mm Vibration Frequency : 10~55Hz One cycle 60 seconds to 3 directions of X,Y,Z for Each 15 minutes	3
Static electricity test	Endurance test applying the electric stress to the finished product housing.	VS=±4KV(contact), ±8KV(air) RS=330Ω CS=150pF 10 times	

Note1: No dew condensation to be observed.

Note2: The function test shall be conducted after 4 hours storage at the normal Temperature and humidity after remove from the test chamber.

Note3: The packing have to including into the vibration testing.

11.Touch Panel Information

NOTES: ALL MATERIALS AND COMPONENTS MUST BE RoHS COMPLIANT.

FRONT VIEW

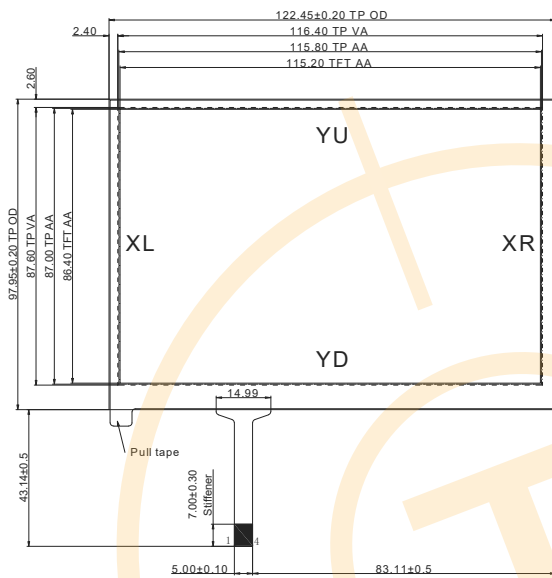

BACK VIEW

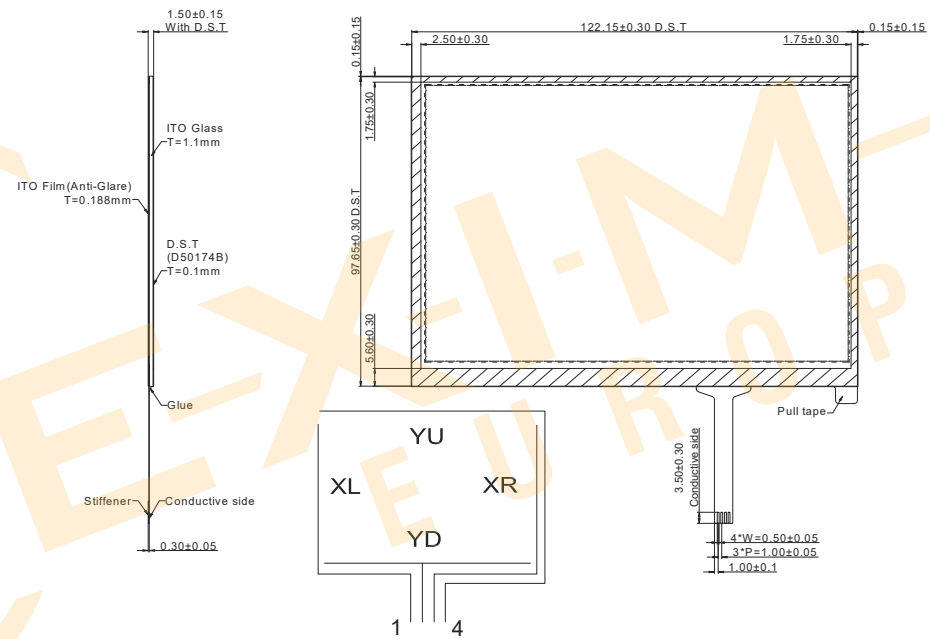

TOUCH PANEL PIN ASSIGNMENT

1	XL	Top Film Terminal
2	YD	Bottom Glass Terminal
3	XR	Top Film Terminal
4	YU	Bottom Glass Terminal

TOLERANCE NOT SPECIFIED: ±0.3mm

11.1. Resistance Touch Panel General Specifications

Item	Description
Supply voltage	DC 5V Max
Activation force	20~120g
Linearity	≤ 1.5%
(Insulation resistance	≥20MΩ (DC 25V)
Light transmission	70%
Structure type	ITO Film/ITO Glass(F/G)
Surface hardness	≥3H (Pencil)
Hitting life time	> 1000,000 times
Loop resistance	X: 200~900Ω
	Y: 200~900Ω



12. Contour Drawing

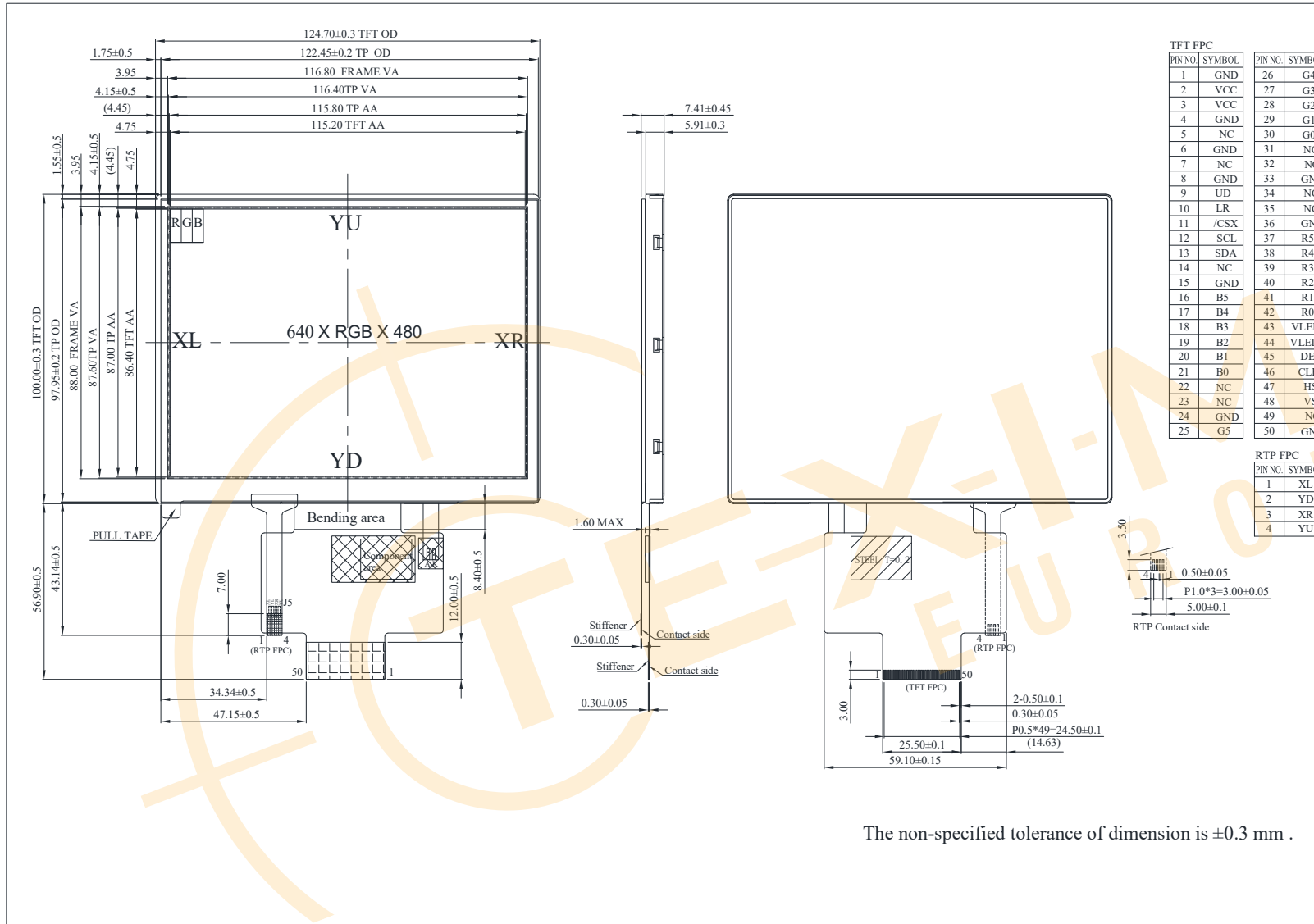

The non-specified tolerance of dimension is ±0.3 mm .



1、Panel Specification :

- 1. Panel Type : Pass NG , _____
- 2. View Direction : Pass NG , _____
- 3. Numbers of Dots : Pass NG , _____
- 4. View Area : Pass NG , _____
- 5. Active Area : Pass NG , _____
- 6. Operating Temperature : Pass NG , _____
- 7. Storage Temperature : Pass NG , _____
- 8. Others : _____

2、Mechanical

- 1. PCB Size : Pass NG , _____
- 2. Frame Size : Pass NG , _____
- 3. Material of Frame : Pass NG , _____
- 4. Connector Position : Pass NG , _____
- 5. Fix Hole Position : Pass NG , _____
- 6. Backlight Position : Pass NG , _____
- 7. Thickness of PCB : Pass NG , _____
- 8. Height of Frame to PCB : Pass NG , _____
- 9. Height of Module : Pass NG , _____
- 10. Others : Pass NG , _____

3、Relative Hole Size :

- 1. Pitch of Connector : Pass NG , _____
- 2. Hole size of Connector : Pass NG , _____
- 3. Mounting Hole size : Pass NG , _____
- 4. Mounting Hole Type : Pass NG , _____
- 5. Others : Pass NG , _____

4、Backlight Specification :

- 1. B/L Type : Pass NG , _____
- 2. B/L Color : Pass NG , _____
- 3. B/L Driving Voltage (Reference for LED) : Pass NG , _____
- 4. B/L Driving Current : Pass NG , _____
- 5. Brightness of B/L : Pass NG , _____
- 6. B/L Solder Method : Pass NG , _____
- 7. Others : Pass NG , _____

>> **Go to page 2** <<



Winstar Module Number : _____

Page: 2

5、Electronic Characteristics of Module :

- | | | | |
|------------------------------|-------------------------------|-------------------------------|-------|
| 1. Input Voltage : | <input type="checkbox"/> Pass | <input type="checkbox"/> NG , | _____ |
| 2. Supply Current : | <input type="checkbox"/> Pass | <input type="checkbox"/> NG , | _____ |
| 3. Driving Voltage for LCD : | <input type="checkbox"/> Pass | <input type="checkbox"/> NG , | _____ |
| 4. Contrast for LCD : | <input type="checkbox"/> Pass | <input type="checkbox"/> NG , | _____ |
| 5. B/L Driving Method : | <input type="checkbox"/> Pass | <input type="checkbox"/> NG , | _____ |
| 6. Negative Voltage Output : | <input type="checkbox"/> Pass | <input type="checkbox"/> NG , | _____ |
| 7. Interface Function : | <input type="checkbox"/> Pass | <input type="checkbox"/> NG , | _____ |
| 8. LCD Uniformity : | <input type="checkbox"/> Pass | <input type="checkbox"/> NG , | _____ |
| 9. ESD test : | <input type="checkbox"/> Pass | <input type="checkbox"/> NG , | _____ |
| 10. Others : | <input type="checkbox"/> Pass | <input type="checkbox"/> NG , | _____ |

6、Summary :

Sales signature : _____

Customer Signature : _____

Date : / / _____

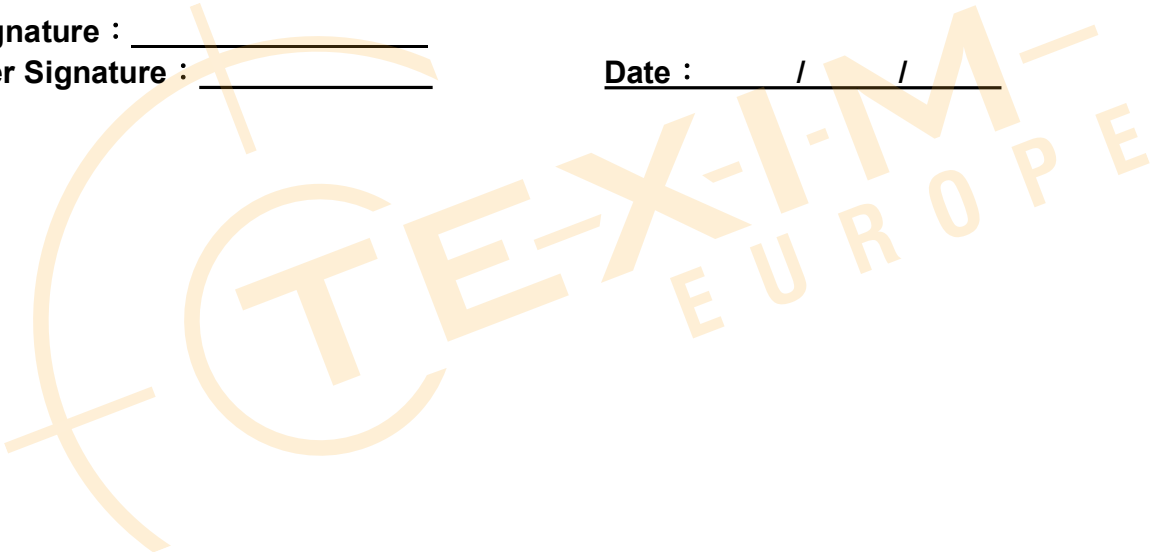

Disclaimer

ALL PRODUCTS, PRODUCT SPECIFICATIONS AND DATA ARE SUBJECT TO CHANGE WITHOUT NOTICE TO IMPROVE RELIABILITY, FUNCTION OR DESIGN OR OTHERWISE.

Texim Europe B.V. its affiliates, agents, and employees, and all persons acting on its or their behalf (collectively, "Texim"), disclaim any and all liability for any errors, inaccuracies or incompleteness contained in any datasheet or in any other disclosure relating to any product.

Texim makes no warranty, representation or guarantee regarding the suitability of the products for any particular purpose or the continuing production of any product.

It is the customer's responsibility to validate that a particular product with the properties described in the product specification is suitable for use in a particular application.

Parameters provided in datasheets and / or specifications may vary in different applications and performance may vary over time.

All operating parameters, including typical parameters, must be validated for each customer application by the customer's technical experts.

Please contact us if you have any questions about the contents of the datasheet.

This may not be the latest version of the datasheet. Please check with us if a later version is available.

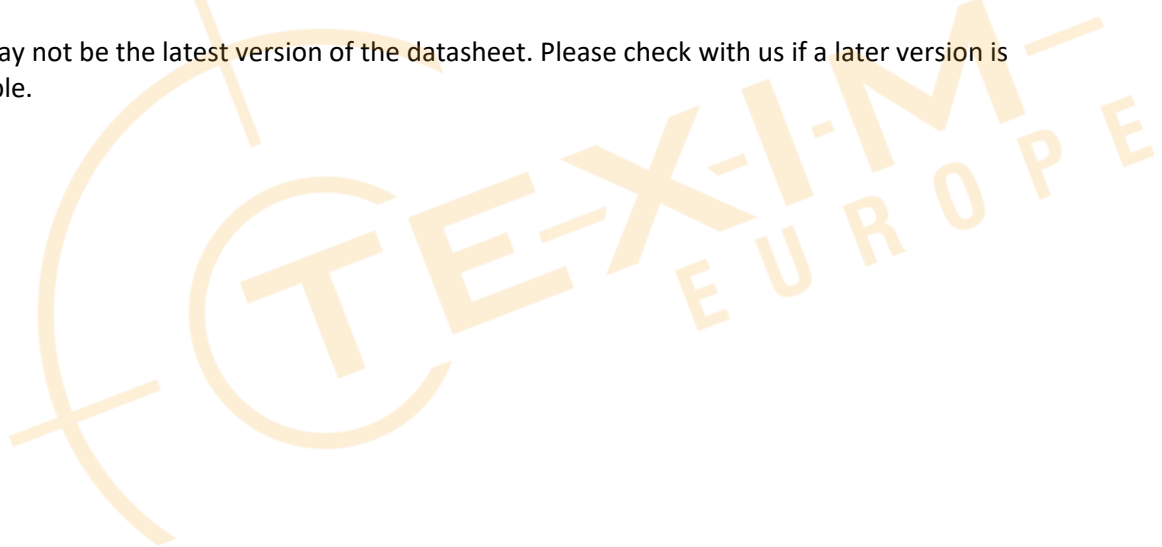



Headquarters & Warehouse

Elektrostraat 17
NL-7483 PG Haaksbergen
The Netherlands

T: +31 (0)53 573 33 33
E: info@texim-europe.com
Homepage: www.texim-europe.com



The Netherlands

Elektrostraat 17
NL-7483 PG Haaksbergen

T: +31 (0)53 573 33 33
E: nl@texim-europe.com



Belgium

Zuiderlaan 14, box 10
B-1731 Zellik

T: +32 (0)2 462 01 00
E: belgium@texim-europe.com



UK & Ireland

St Mary's House, Church Lane
Carlton Le Moorland
Lincoln LN5 9HS

T: +44 (0)1522 789 555
E: uk@texim-europe.com

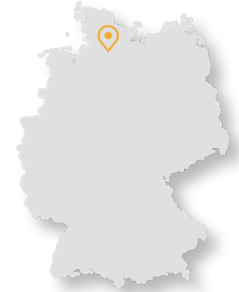

Germany - North

Bahnhofstrasse 92
D-25451 Quickborn

T: +49 (0)4106 627 07-0
E: germany@texim-europe.com

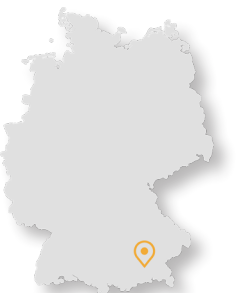

Germany - South

Martin-Kollar-Strasse 9
D-81829 München

T: +49 (0)89 436 086-0
E: muenchen@texim-europe.com



Austria

Warwitzstrasse 9
A-5020 Salzburg

T: +43 (0)662 216 026
E: austria@texim-europe.com



Nordic

Søndre Jagtvej 12
DK-2970 Hørsholm

T: +45 88 20 26 30
E: nordic@texim-europe.com



Italy

Martin-Kollar-Strasse 9
D-81829 München

T: +49 (0)89 436 086-0
E: italy@texim-europe.com