

CP-014 Series 4.20mm (.165") Right Angle DIP Solder Headers

- ⊙ Optional with mounting ears or pegs
- ⊙ Mates with CP-011 connector
- ⊙ Nylon 66 UL 94V-0 or V-2 insulator material
- ⊙ Glow wire test approval material available

RoHS Compliant  

Distributed by:

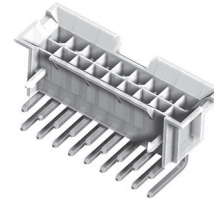
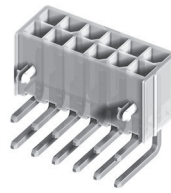

P/N CP-014**140 / CP-014**150 / CP-014**1G0

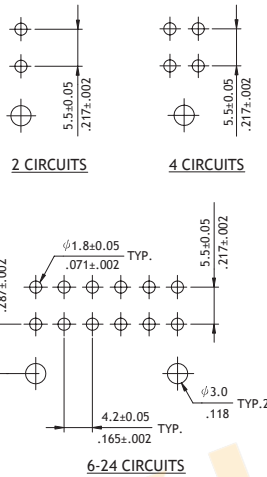
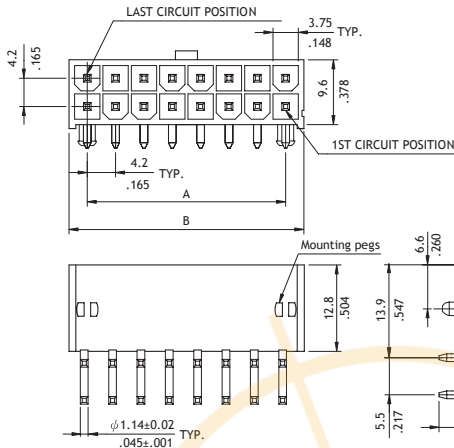

Circuits	Dimension	
	A	B
2	-	6.0(.236)
4	4.2(.165)	10.2(.402)
6	8.4(.331)	14.4(.567)
8	12.6(.496)	18.6(.732)
10	16.8(.661)	22.8(.898)
12	21.0(.827)	27.0(1.063)
14	25.2(.992)	31.2(1.228)
16	29.4(1.157)	35.4(1.394)
18	33.6(1.322)	39.6(1.559)
20	37.8(1.487)	43.8(1.724)
22	42.0(1.652)	48.0(1.890)
24	46.2(1.817)	52.2(2.055)

Recommended PCB Layout

P/N CP-014**160 / CP-014**170 / CP-014**1H0

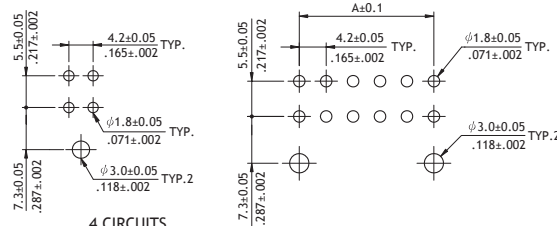
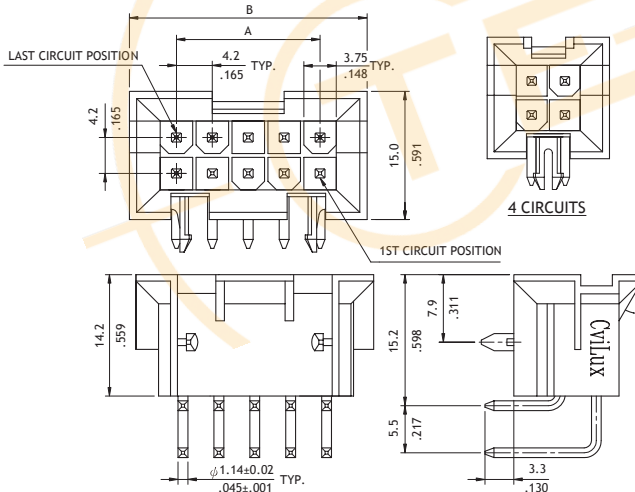

Circuits	Dimension	
	A	B
4	4.2(.165)1	5.2(.598)
6	8.4(.331)	19.4(.764)
10	16.8(.661)	27.8(1.094)
14	25.2(.992)	36.2(1.425)
18	33.6(1.323)	44.6(1.756)
24	46.2(1.819)	57.2(2.252)

Recommended PCB Layout

Ordering Code

① CP - 01 ② 4 ③ 2 ④ 4 ⑤ 1 ⑥ 4 ⑦ 0

- ① Series No.
- ② Connector Type:
4 = Right Angle Header
- ③ No. of Circuits:
see above table
- ④ Plating: 1 = Tin over Nickel

- ⑤ Variation:
4 = UL 94V-2 (with mounting pegs)
5 = UL 94V-0 (with mounting pegs)
6 = UL 94V-2 (B.M.I Type)
7 = UL 94V-0 (B.M.I Type)
G = GWT Type (with mounting pegs)
H = GWT Type (B.M.I Type)

- ⑥ Other Options:
0 = Standard
*Special options consult manufacturer

Disclaimer

ALL PRODUCTS, PRODUCT SPECIFICATIONS AND DATA ARE SUBJECT TO CHANGE WITHOUT NOTICE TO IMPROVE RELIABILITY, FUNCTION OR DESIGN OR OTHERWISE.

Texim Europe B.V. its affiliates, agents, and employees, and all persons acting on its or their behalf (collectively, "Texim"), disclaim any and all liability for any errors, inaccuracies or incompleteness contained in any datasheet or in any other disclosure relating to any product.

Texim makes no warranty, representation or guarantee regarding the suitability of the products for any particular purpose or the continuing production of any product.

It is the customer's responsibility to validate that a particular product with the properties described in the product specification is suitable for use in a particular application.

Parameters provided in datasheets and / or specifications may vary in different applications and performance may vary over time.

All operating parameters, including typical parameters, must be validated for each customer application by the customer's technical experts.

Please contact us if you have any questions about the contents of the datasheet.

This may not be the latest version of the datasheet. Please check with us if a later version is available.

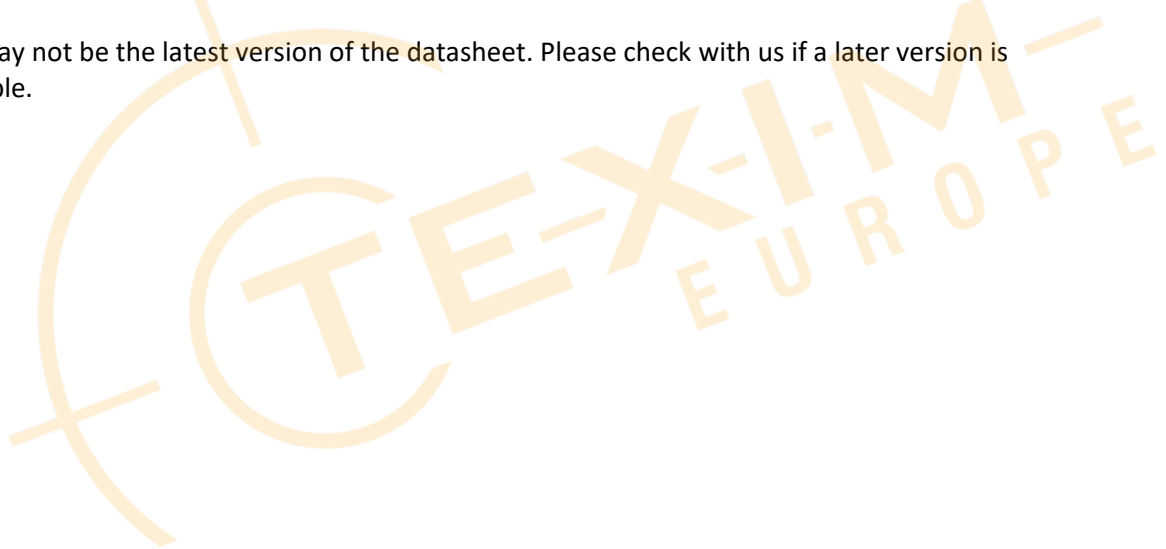



Headquarters & Warehouse

Elektrostraat 17
NL-7483 PG Haaksbergen
The Netherlands

T: +31 (0)53 573 33 33
E: info@texim-europe.com
Homepage: www.texim-europe.com



The Netherlands

Elektrostraat 17
NL-7483 PG Haaksbergen

T: +31 (0)53 573 33 33
E: nl@texim-europe.com



Belgium

Zuiderlaan 14, box 10
B-1731 Zellik

T: +32 (0)2 462 01 00
E: belgium@texim-europe.com



UK & Ireland

St Mary's House, Church Lane
Carlton Le Moorland
Lincoln LN5 9HS

T: +44 (0)1522 789 555
E: uk@texim-europe.com



Germany - North

Bahnhofstrasse 92
D-25451 Quickborn

T: +49 (0)4106 627 07-0
E: germany@texim-europe.com



Germany - South

Martin-Kollar-Strasse 9
D-81829 München

T: +49 (0)89 436 086-0
E: muenchen@texim-europe.com



Austria

Warwitzstrasse 9
A-5020 Salzburg

T: +43 (0)662 216 026
E: austria@texim-europe.com



Nordic

Søndre Jagtvej 12
DK-2970 Hørsholm

T: +45 88 20 26 30
E: nordic@texim-europe.com



Italy

Martin-Kollar-Strasse 9
D-81829 München

T: +49 (0)89 436 086-0
E: italy@texim-europe.com