

## AXO®301 – High resolution $\pm 1$ g MEMS accelerometer with digital interface

### Key Performances

- Input range:  $\pm 1$  g
- Resolution: 50  $\mu$ g
- Scale factor nonlinearity: 80 ppm
- Noise density: 9  $\mu$ g/ $\sqrt{\text{Hz}}$
- 1 year composite bias repeatability: 1 mg
- Bandwidth: 15 Hz (configurable upon request)
- Compliant with EN61373 railway standard for vibrations and shocks

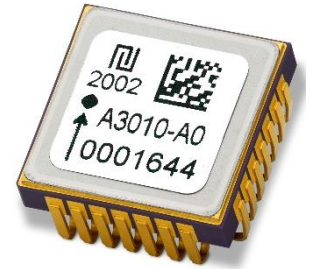

### Key Features

- 24-bit digital SPI interface
- Initial and continuous self-test
- Factory-calibrated over temperature
- Hermetic ceramic SMD package
- Non classified under dual-use export control
- REACH and RoHS compliant

### Key Applications

- Acceleration and deceleration measurements
- Train odometry and Automated Train Control
- Train performance testing
- Train tilt measurement
- Static and dynamic inclinometers
- Motion control of construction machinery

### General Description

AXO®301 is a single-axis, high resolution and low noise closed-loop MEMS accelerometer with  $\pm 1$  g input range that offers a digital and cost-effective alternative to quartz accelerometers at a fraction of their size, weight, and power consumption. It is perfectly suited to high resolution acceleration and inclination measurements for applications operating in vibrating environments, such as high-end industrial and railway systems.

The 24-bit digital SPI interface eases the integration of AXO®301 into high performance IMU and INS, while the built-in self-test ensures initial verification of the sensor's integrity and continuous in-operation functionality test.

AXO®301 is free from dual-use export control, as well as REACH and RoHS compliant. It is ideally complemented by GYPRO® high performance digital gyroscopes.

All AXO® & GYPRO® products sensors are factory calibrated and compensated for temperature effects to provide high-accuracy digital output over a broad temperature range. Raw data output can be also chosen to enable customer-made compensations.

### Disclaimer

*Information furnished by Tronics is believed to be accurate and reliable. However, no responsibility is assumed by Tronics for its use, nor for any infringements of patents or other rights of third parties that may result from its use.*

*Specification subject to change without notice.*

*No license is granted by implication or otherwise under any patent or patent rights of Tronics. Trademarks and registered trademarks are the property of their respective owner.*



## Table of Contents

Block diagram .....	3
Overall dimensions (with MEMS transducer gravity center in blue) .....	3
1. Specifications .....	4
2. Absolute maximum ratings .....	6
3. Typical performances .....	7
4. Interface .....	9
4.1. Pinout, Sensitive Axis identification .....	9
4.2. Application circuit .....	9
4.3. Input/Output Pin Definitions .....	10
5. Soldering Recommendations .....	11
6. Digital SPI interface .....	12
6.1. Electrical and Timing Characteristics .....	12
6.2. SPI frames description .....	13
6.3. Acceleration readings .....	13
6.4. Temperature readings .....	13
6.5. Advanced use of SPI registers .....	14
6.6. Modification of the data rate .....	16
7. Acceleration calibration procedure .....	17
7.1. Algorithm overview .....	17
7.2. Programming of the new coefficients .....	18
7.3. Switch to uncompensated data output .....	19
8. Temperature Sensor Calibration Procedure .....	20
8.1. Temperature sensor calibration model .....	20
8.2. Recommended Procedure .....	20
9. Device Identification .....	21
9.1. Device information .....	21
9.2. Ordering information .....	21
10. Internal construction and Theory of Operation .....	22
11. Available Tools and Resources .....	23
12. Revision History .....	24

Block diagram

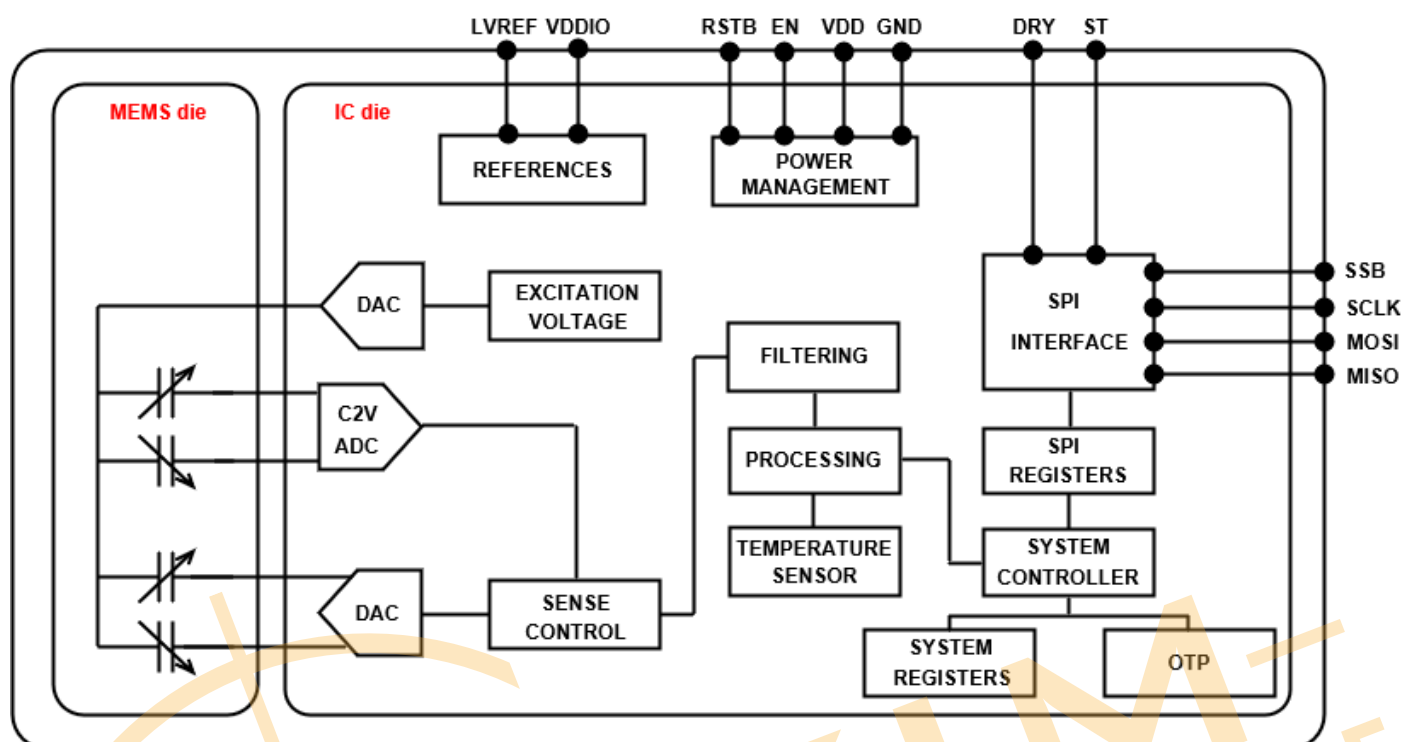

Overall dimensions (with MEMS transducer gravity center in blue)

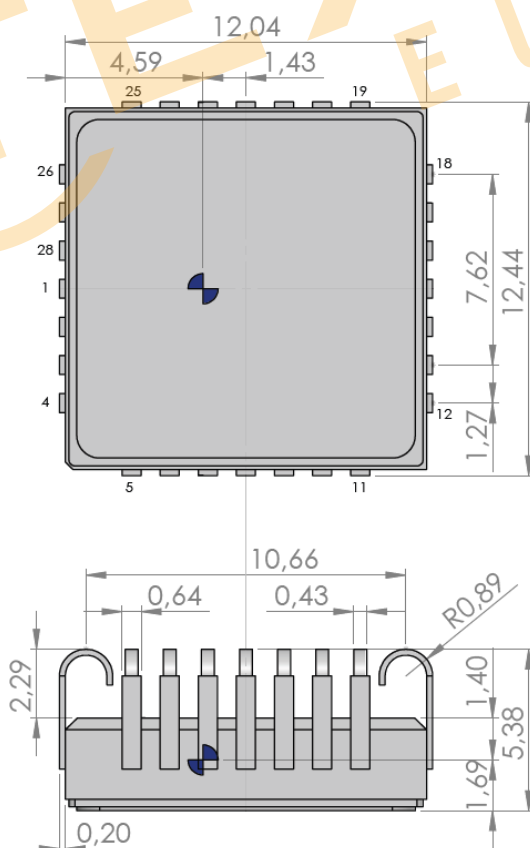

## 1. Specifications

Parameter	Unit	Min	Nom	Max <sup>(2)</sup>	Notes
<b>Measurement Ranges</b>					
Full scale range	g		±1		Electronic clamping is applied, and sensors will saturate around ±7g
Temperature range	°C	-40		+85	
<b>Bias</b>					
1 year composite bias repeatability	mg		1		Total bias drift per year, quadratic sum of all bias errors
Bias instability	µg		3	15	Lowest point of Allan variance curve at room temperature
Bias in-run (short term) stability	µg		15	30	Standard deviation of the 1 second filtered output over 1 hour at room temperature, after 30 min of stabilization
Residual bias temperature error, calibrated <sup>(1)(3)(5)</sup>	mg		0.5	1.5	Maximum variation of the bias over the specified temperature range
Bias repeatability	µg		220		See note <sup>(4)</sup>
Bias long term stability	mg		0.14		Drift per year, based on Allan variance extrapolation
Warm-up bias drift	µg		50		Bias drift during initial sensor self-heating after power on at 0g
Vibration Rectification Error (VRE)	µg/g <sup>2</sup>		20		Bias rectification under operating vibrations; root mean square of all axis
<b>Scale Factor</b>					
Scale factor <sup>(1)</sup>	LSB/g		1 000 000		Nominal scale factor
1 year composite scale factor repeatability	ppm		1 000		Total scale factor drift per year, quadratic sum of all scale factor errors
Residual scale factor temperature error, calibrated <sup>(1)(3)</sup>	ppm		500	1 000	Maximum variation of the scale factor over the specified temperature range
Scale factor repeatability	ppm		280		See note <sup>(4)</sup>
Scale factor long term stability	ppm		700		Drift per year, based on Allan variance extrapolation
<b>Linearity, Noise</b>					
Non linearity <sup>(1)</sup>	ppm		80	350	Maximum deviation of the output from the expected value using a best fit straight line over the [0g ; 1g] range, at room temperature
Noise density	µg/√Hz		9		Over the [1 - 15] Hz frequency range, at room temperature
Broadband resolution	µg rms		50		Sensor resolution over full frequency range
Velocity Random Walk (VRW)	m/s/√h		0.005		-1/2 slope tangent, based on Allan Variance at 1s
<b>Frequency response</b>					
Bandwidth	Hz		15		Defined as the frequency for which attenuation is equal to -3dB
Data Rate (DR)	Hz		950		Refresh rate of the output data at room temperature Customizable upon request (see section 6.6)

Parameter	Unit	Min	Nom	Max <sup>(2)</sup>	Notes
Latency	ms		20		Time delay between the physical acceleration (input) and the output signal
Start-up time <sup>(6)</sup>	ms		400		Time interval between the application of power and the presence of a usable output, i.e. at least 90% of the input, at room temperature
<b>Axis alignment</b>					
Axis misalignment	mrad		20		By design
<b>Environmental</b>					
Storage temperature range	°C	-55		+125	
Component shelf life	Years		5		
Humidity at 45°C	%		<98		
Moisture Sensitivity Level (MSL)	--		1		Unlimited (hermetic package)
Shock (operating)	g   ms		100   6		Half sine - EN 61373 standard
Shock (survival)	g   ms		2000   0.3		
Vibrations (operating)	g <sub>rms</sub>		3.8		Railway profile (10Hz – 500Hz) - EN 61373 standard
Vibrations (survival)	g <sub>rms</sub>		20		Random acceleration, applied on any axis within 20Hz to 2kHz during 10min
<b>Electrical</b>					
Power supply voltage	V	4.75	5.00	5.25	
Current consumption (normal mode) <sup>(1)</sup>	mA			30	Tested at room temperature
Current consumption (power down mode)	µA			5	Power down mode is activated by switching EN pin to GND, at room temperature
Power supply rejection ratio	µg/V		130		
<b>Temperature sensor</b>					
Scale factor (raw data)	LSB/°C		85		Temperature sensor is not factory-calibrated
25°C typical output (raw data)	LSB		8 000		Temperature sensor is not factory-calibrated
Refresh rate	Hz		6		
<b>Reliability</b>					
MTBF	h		>1 000 000		Predictive elapsed time between inherent failures of the sensor during normal system operation for 50°C use temperature

Table 1: Specifications

<sup>(1)</sup> 100% tested in production.<sup>(2)</sup> Max values for parameters not 100% tested in production are ±3 sigma from validation test population.<sup>(3)</sup> Temperature range of -40°C to +85°C.<sup>(4)</sup> Bias and scale factor repeatabilities include the following parameters:

- Turn On to Turn Off repeatability at constant temperature and constant accelerations,
- Repeatability over temperature, at constant acceleration,
- Repeatability over acceleration, at constant temperature,
- Day to day repeatability, over ten days.

<sup>(5)</sup> Due to the sigma delta architecture, there is a dead band of 200µg around zero input level.<sup>(6)</sup> Startup guaranteed at -20°C. Applications requiring start at temperature below -20°C require dedicated integration constraints and/or specific product configuration. Please contact us for more information.

## 2. Absolute maximum ratings

Stresses at or exceeding the maximum ratings listed below may cause permanent damage to the device, or affect its reliability. Exposure to maximum ratings conditions for extended periods may also affect device reliability.

Functional operation is not guaranteed once stresses exceeding the maximum ratings have been applied.

Parameter	Unit	Min	Max
Supply voltage	V	-0.5	+7
Electrostatic Discharge (ESD) protection, any pin, Human Body Model	kV	--	±2
Storage temperature range	°C	-55	+125
Shock survival, half sine	g	--	2000
Vibrations survival, 20-2000Hz	g <sub>rms</sub>	--	20
Ultrasonic cleaning		Not allowed	

Table 2: Absolute maximum ratings

### Caution!



The product may be damaged by ESD, which can cause performance degradation or device failure! We recommend handling the device only on a static safe work station. Precaution for the storage should also be taken.



The sensor **MUST** be powered-on *before* any SPI operation, as shown in Figure 1 below. Having the SPI pads, VDDIO or EN at a high level while VDD is at a low level could damage the sensor, due to ESD protection diodes and buffers.



Sensor product stresses at or above those listed under Table 2 Maximum ratings, may cause permanent damage, and may affect product reliability

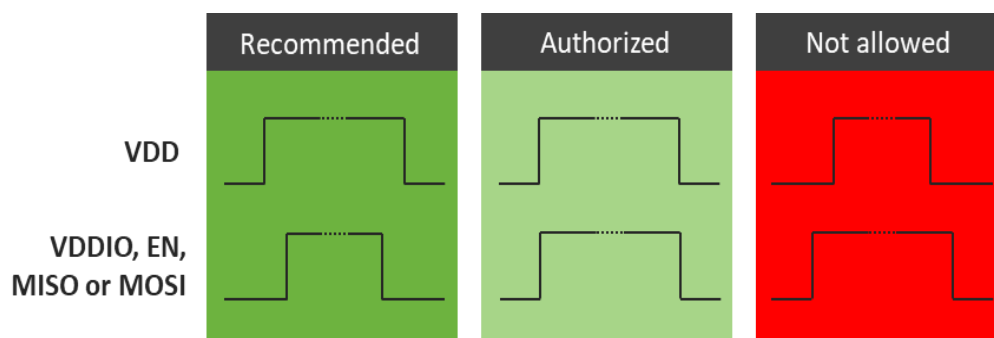

Figure 1: Recommended voltage sequence

### 3. Typical performances

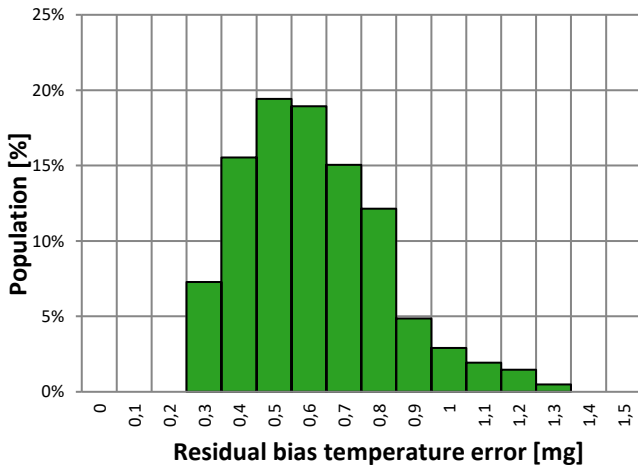

Figure 2: Residual bias temperature error distribution, absolute value

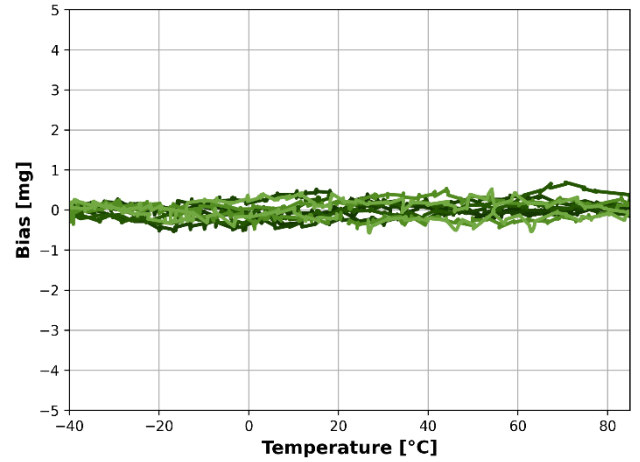

Figure 5: Residual bias temperature error

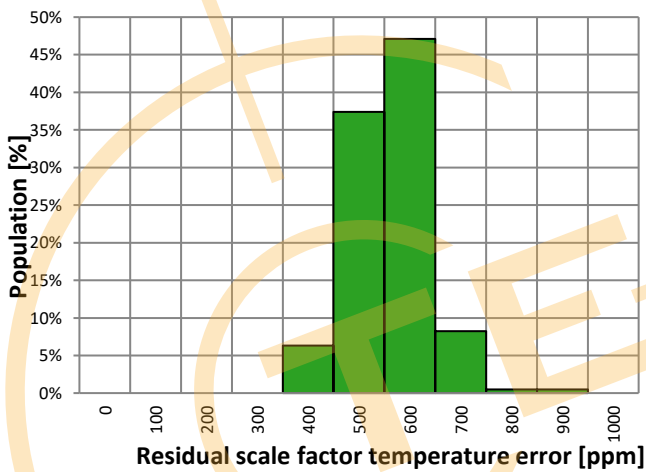

Figure 3: Residual scale factor temperature error distribution, absolute value

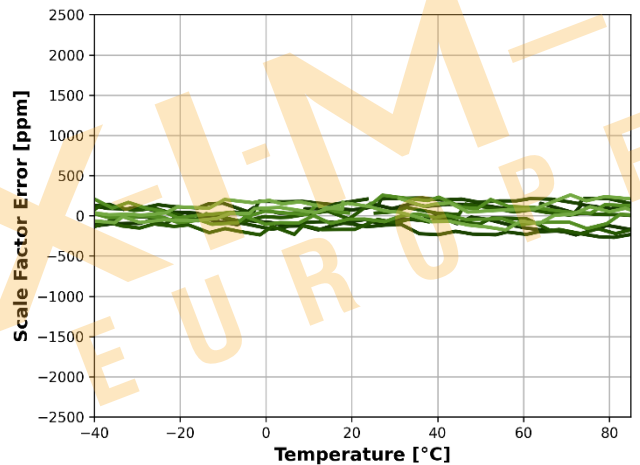

Figure 6: Residual scale factor temperature error

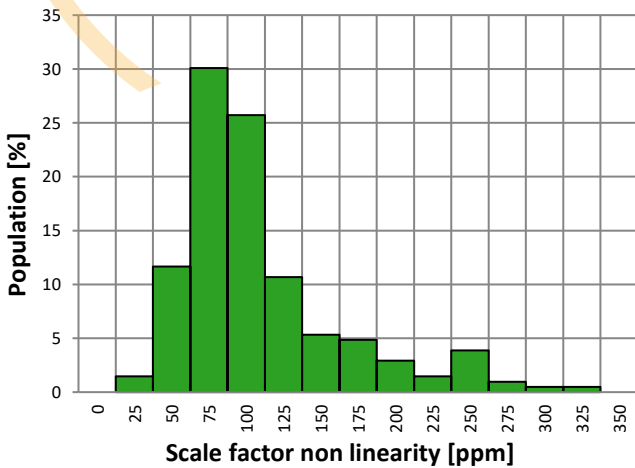

Figure 4: Scale Factor non linearity distribution (room temperature)

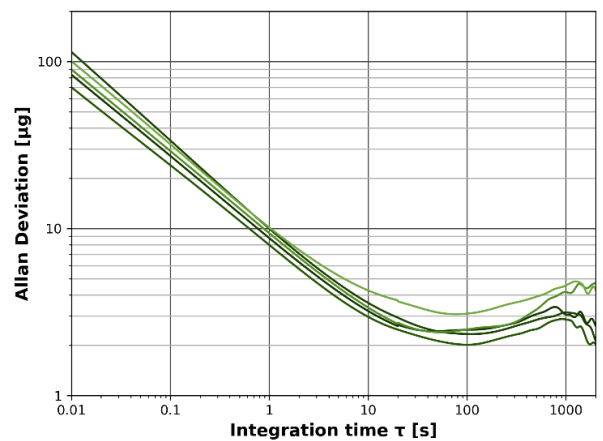

Figure 7: Allan variance

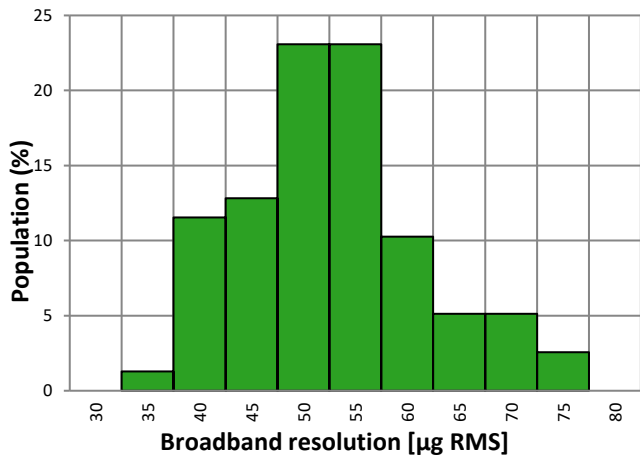

Figure 8: Broadband resolution distribution (room temperature)

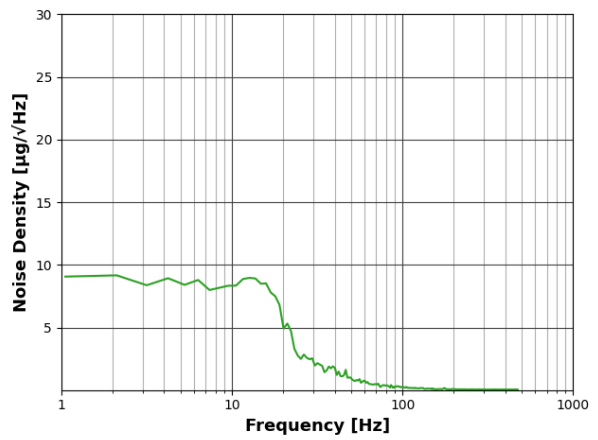

Figure 10: Noise density (room temperature)

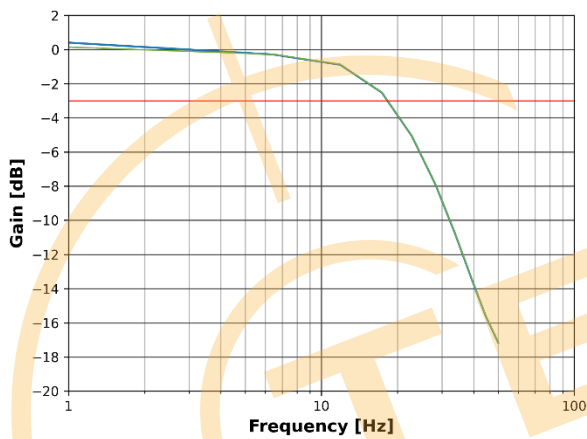

Figure 9: Frequency response

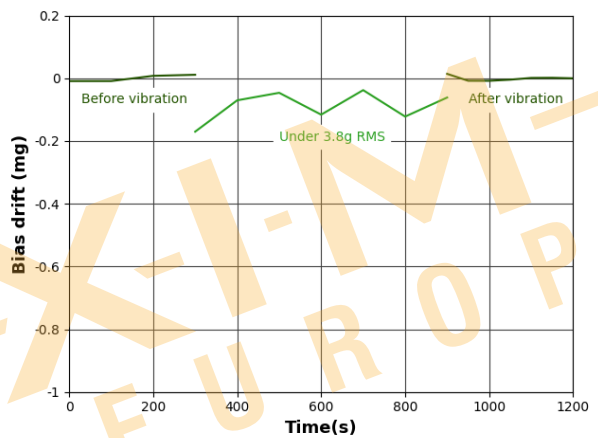

Figure 11: Bias drift under vibration  
 (3.8 g RMS profile, root mean square of all axis)



## 4. Interface

### 4.1. Pinout, Sensitive Axis identification

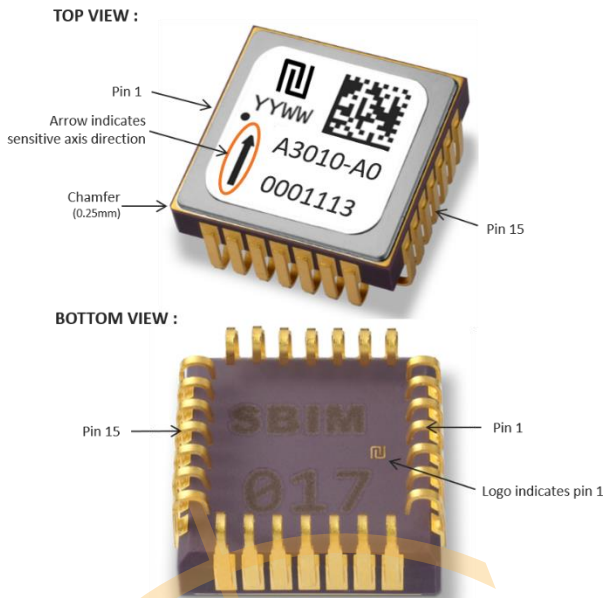

Figure 12: How to locate Pin 1 and Sensitive Axis

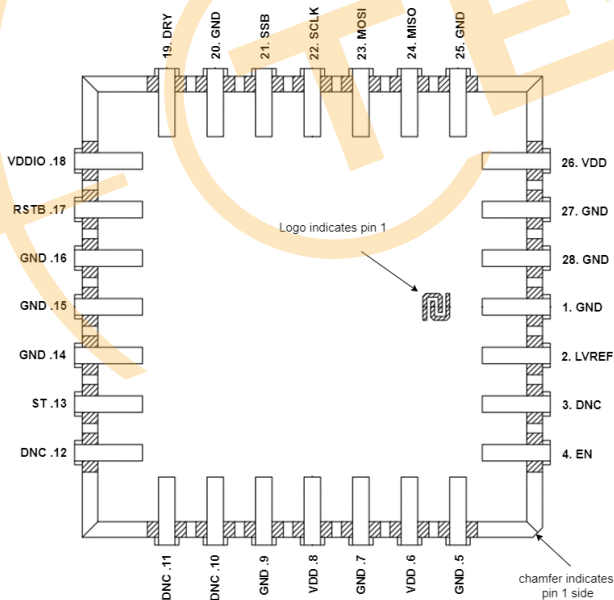

Figure 13: AXO301 Sensors Pinout (BOTTOM VIEW)

### 4.2. Application circuit

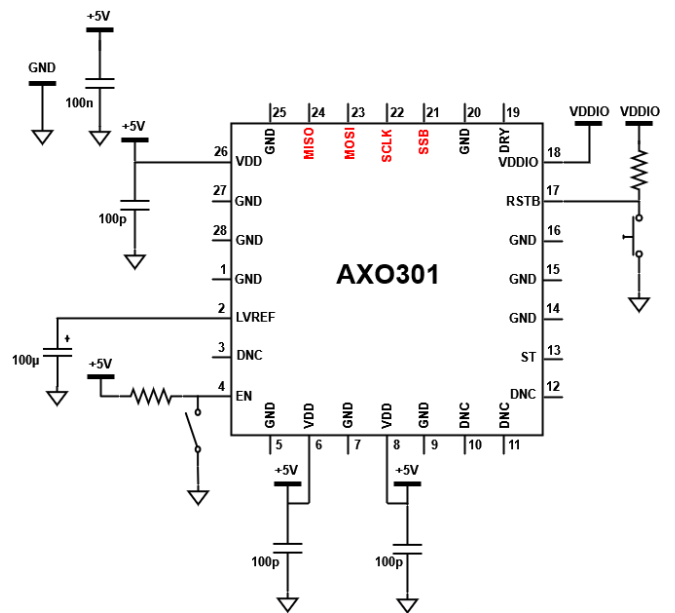

Figure 14: Recommended Application Schematic

#### Notes:

- All capacitances of Figure 14 should be placed as close as possible to their corresponding pins, except the 100nF capacitance between VDD and GND, which should be as close as possible to the board's supply input.
- The 100µF filtering capacitance between LVREF and GND should have low Equivalent Series Resistance (ESR < 1Ω) and low leakage current (< 6µA).
- The digital pads maximum ratings are GND-0.3V and VDD+0.3V.

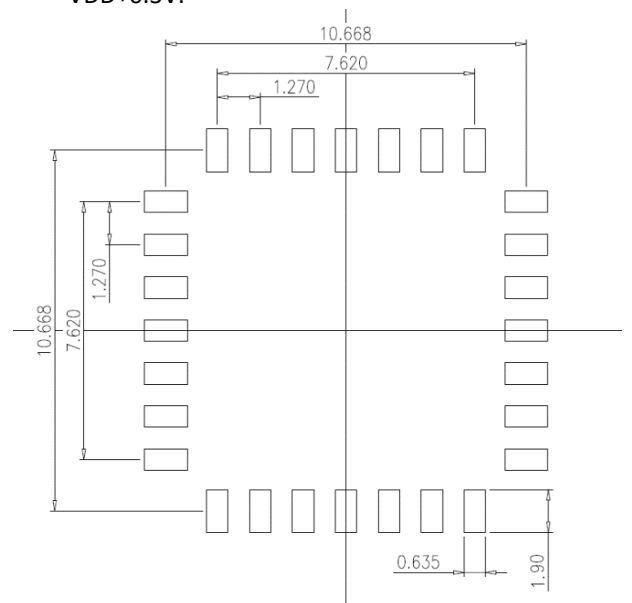

Figure 15: Recommended Pad Layout (dimensions in mm)

## 4.3. Input/Output Pin Definitions

Pin name	Pin number	Pin type	Pin direction	Pin levels	Function
<b>GND</b>	1, 5, 7, 9, 14, 15, 16, 20, 25, 27,28	Supply	n/a	0V	Power Ground
<b>VDD</b>	6, 8, 26	Supply	n/a	+5V	Power Supply
<b>MISO</b>	24	Digital	Output	VDDIO	Master Input Slave Output signal
<b>MOSI</b>	23	Digital	Input	VDDIO	Master Output Slave Input signal
<b>SCLK</b>	22	Digital	Input	VDDIO	SPI clock signal
<b>SSB</b>	21	Digital	Input	VDDIO	Slave Selection signal. Active low
<b>DRY</b>	19	Digital	Output	VDDIO	Data Ready flag. Generates a pulse when a new acceleration data is available
<b>VDDIO</b>	18	Supply	n/a	+1.8V to +5V	Reference voltage for the SPI signals and DRY, RSTB wires
<b>RSTB</b>	17	Digital	Input	VDDIO with pull-up of 100kΩ	Reset. Reloads the internal calibration data. Active low
<b>ST</b>	13	Digital	Output	+5V	Self-test status high when the sensor is properly operating See 6.3.3 for details
<b>EN</b>	4	Digital	Input	+5V with pull up of 100kΩ	Enable command. Active high.
<b>LVREF</b>	2	Analog	n/a	4.4V	External decoupling pad. MUST be connected to the board's GND through a 100μF external capacitor, in order to ensure low noise.
<b>DNC</b>	3, 10, 11, 12	--	--	--	Do Not electrically Connect. These pins provide additional mechanical fixing to the board and should be soldered to an unconnected pad.

Table 3: Pin Functions

## 5. Soldering Recommendations

Please note that the reflow profile to be used does not depend only on the sensor. The whole populated board characteristics shall be considered.

MEMS components are sensitive to mechanical stress coming from the Printed Circuit Board (PCB) during the soldering reflow. In order to achieve the best performance, it is recommended to do an on-board calibration after the soldering of the sensor.

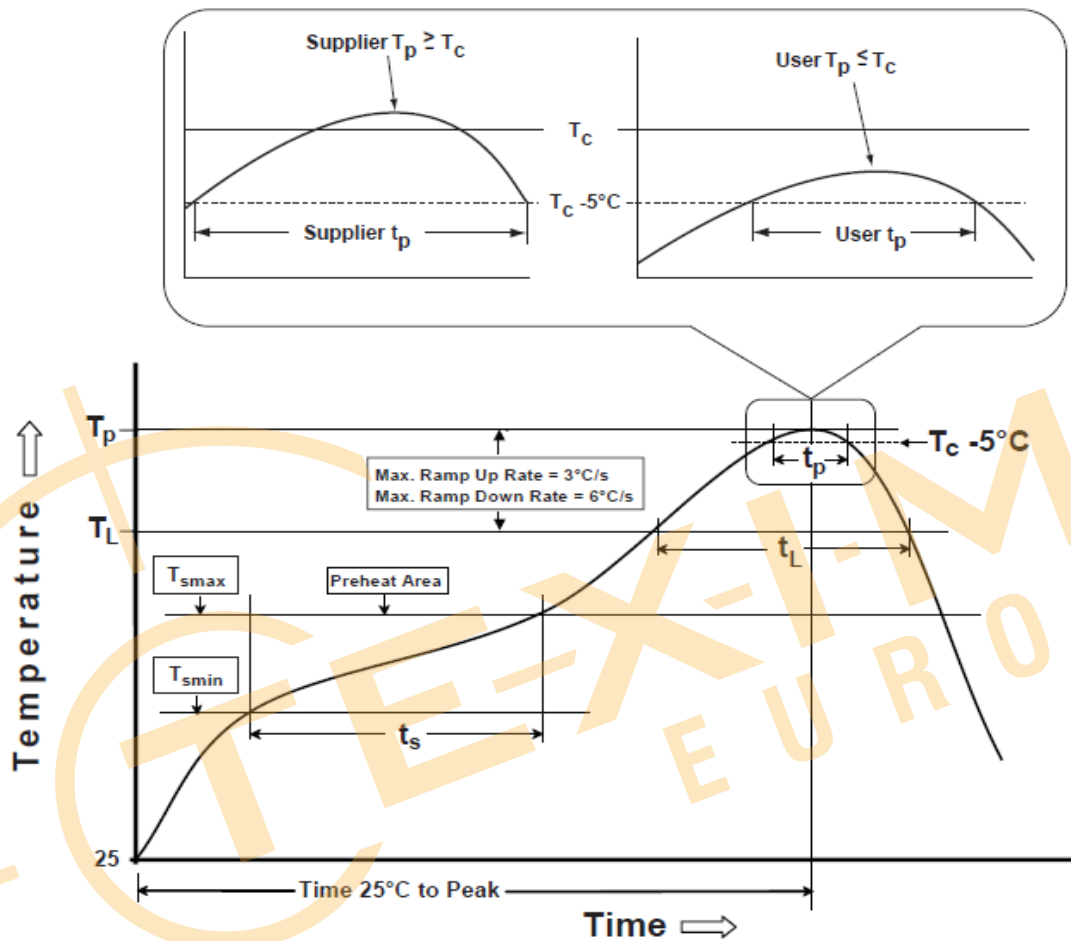

Figure 16: Reflow Profile, according to IPC/JEDEC J-STD-020D.1

Profile Feature	
<b>Time maintained above</b>	
Temperature ( $T_L$ )	183°C
Time ( $t_L$ )	60-150 sec
Peak Temperature ( $T_p$ )	240°C (+/-5°C)
Time within 5°C of Actual Peak Temperature ( $t_p$ )	10-30 sec

Table 4: Reflow Profile Details, according to IPC/JEDEC J-STD-020D.1

## 6. Digital SPI interface

### 6.1. Electrical and Timing Characteristics

The device acts as a slave supporting only SPI "mode 0" (clock polarity CPOL=0, clock phase CPHA=0).

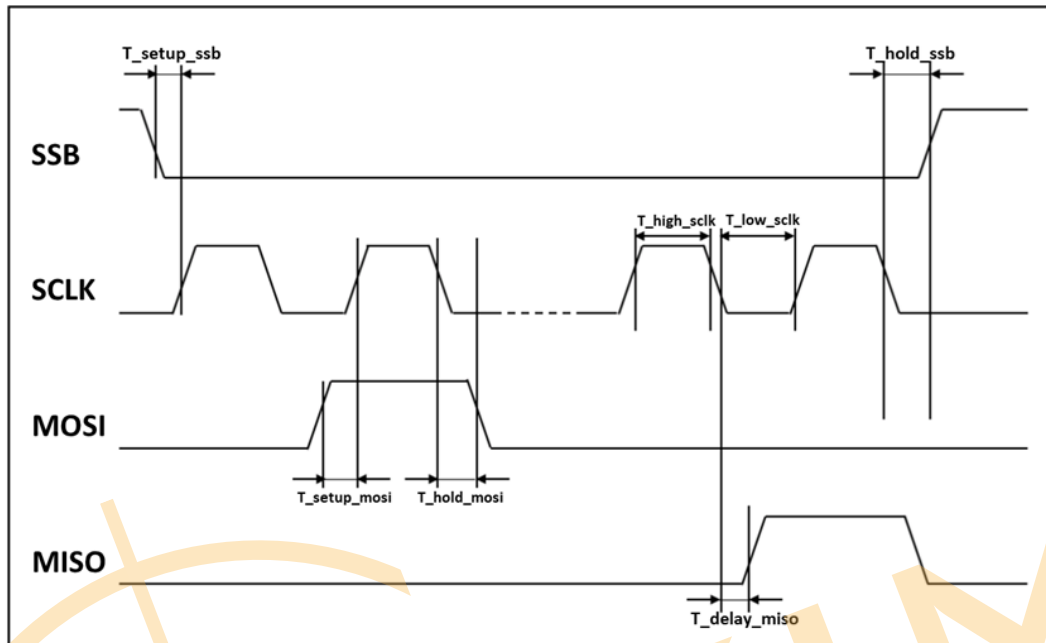

Figure 17: SPI timing diagram

Symbol	Parameter	Condition	Unit	Min	Typ	Max
<b>Electrical characteristics</b>						
VIL	Low level input voltage		VDDIO	0		0.1
VIH	High level input voltage		VDDIO	0.8		1
VOL	Low level output voltage	ioL=0mA (Capacitive Load)	V		GND	
VOH	High level output voltage	ioH=0mA (Capacitive Load)	V		VDDIO	
Rpull_up	Pull-up resistor	Internal pull-up resistance to VDD	kΩ		100	
Rpull_down	Pull-down resistor	Internal pull-down resistance to GND	kΩ		-	
<b>Timing parameters</b>						
Fspi	SPI clock input frequency	Maximal load 25pF on MOSI or MISO	MHz		0.2	8
T_low_sclk	SCLK low pulse		ns	62.5		
T_high_sclk	SCLK high pulse		ns	62.5		
T_setup_mosi	MOSI setup time		ns	10		
T_hold_mosi	MOSI hold time		ns	5		
T_delay_miso	MISO output delay	Load 25pF	ns			40
T_setup_ssb	SSB setup time		Tsclk	1		
T_hold_ssb	SSB hold time		Tsclk	1		

Table 5: SPI timing parameters

The MISO pin is kept in high impedance when the SSB level is high, which allows sharing the SPI bus with other components.

**IMPORTANT NOTE: It is forbidden to keep SPI pads at a high level while VDD is at 0V due to ESD protection diodes and buffers.**

## 6.2. SPI frames description

The SPI frames used for the communication through the SPI Register are composed of an instruction followed by arguments. The SPI instruction is composed of 1 byte, and the arguments are composed of 2, 4 or 8 bytes, depending on the cases, as can be seen in Table 6 below.



Figure 17: SPI Message Structure

Instruction	Argument	Meaning
0x50	0x00000000 (n=4)	Read Acceleration
0x54	0x0000 (n=2)	Read Temperature
0x58	0x00000000 (n=4)	Advanced commands.
0x78	0xFFFFFFFF (n=8)	See Section 6.5 for more details.
0x7C	0XXXXX (n=2)	

Table 6: Authorized SPI commands

## 6.3. Acceleration readings

From the 32-bits (4 bytes) frame obtained after the “Read acceleration” command, the 24-bits word of acceleration data (ACC) must be extracted as shown below in Figure 18.

DRY and ST are respectively the “data ready” and “self-test” bits, also directly available on Pins 11 and 17 of the sensor.

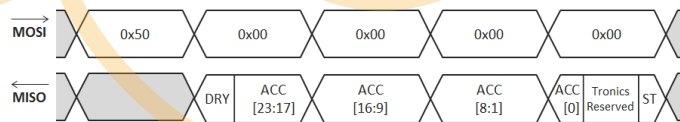

Figure 18: Acceleration reading frames and data organization

### 6.3.1. Acceleration (ACC) output

The 24-bit accelerometer output is coded in two's complement (Table 7).

- If the temperature compensation is not enabled (A\_COMP\_ON=0), then the user should perform scale factor measurements.
- If the temperature compensation of the acceleration output is enabled (default case), dividing the 24-bit value by a factor **1 000 000** results in the acceleration in g, as shown in Table 7.

-7.0000	g	↔	1001 0101 0011 0000 0100 0000
			..
-1.0000	g	↔	1111 0000 1011 1101 1100 0000
			..
-0.000001	g	↔	1111 1111 1111 1111 1111 1111
0.000000	g	↔	0000 0000 0000 0000 0000 0000
+0.000001	g	↔	0000 0000 0000 0000 0000 0001
			..
+1.0000	g	↔	0000 1111 0100 0010 0100 0000
			..
+7.0000	g	↔	0110 1010 1100 1111 1100 0000

Table 7: Conversion table for calibrated acceleration output

### 6.3.2. Data Ready (DRY) bit

The Data Ready bit is a flag which is raised when a new acceleration data is available. The flag stays raised until the data is read.

Similarly to the Data Ready pin, the Data Ready bit signal can be used as an interrupt signal to optimize the delays between newly available data and their readings.

### 6.3.3. Self-Test (ST) bit

AXO provides both an initial self-test, done during the sensor start-up to check the ASIC digital blocks integrity, and a continuous self-test in operation. The continuous self-test checks the integrity of the SPI communication as well as the closed-loop operation: the MEMS mobile mass is at its equilibrium position and the force feedback is operating nominally.

The self-test procedure is running in parallel with the main functions of the sensor. The self-test status is available at the same time as the sensor output.

The ST bit contains the same information as the ST pin. It is updated at the sensor data rate. The ST pin can be connected to an interrupt input.

## 6.4. Temperature readings

The temperature data is an unsigned integer, 14-bits word (TEMP). It must be extracted from the 2 bytes of read data, as shown below in Figure 19.

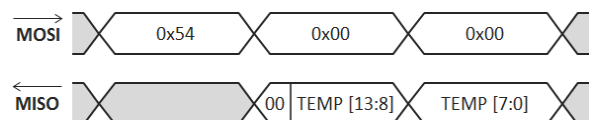

Figure 19: Temperature reading frames and data organization

By default the temperature sensor is *not* factory-calibrated (TOUT\_SEL=0).

## AXO301 Datasheet

### 6.5. Advanced use of SPI registers

SPI registers can also be used to access the System register or the MTP (Multi-Time-Programmable memory) by writing the corresponding SPI command. The following subsections (6.5.1 and 6.5.2) describe the detailed processes to access them by read and write command.

#### 6.5.1. R/W access to the System Registers

**IMPORTANT NOTE:** Modifications to the system registers are **reversible**. Modified registers will *not* be restored after a RESET. There is no limitation to the number of times the system registers can be modified.

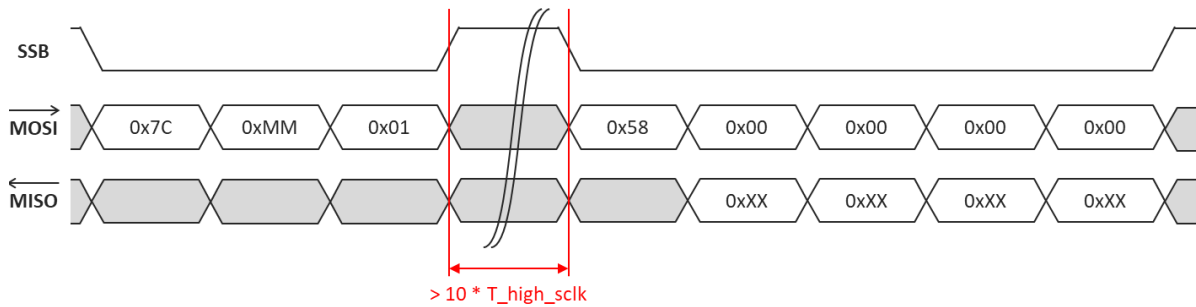

Figure 20: Sequence of instructions to READ address MM of the system registers

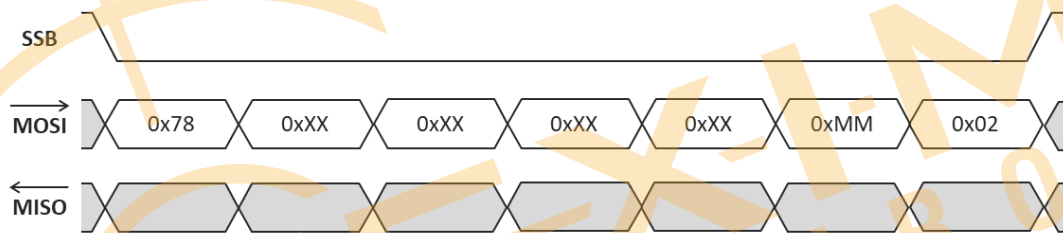

Figure 21: Sequence of instructions to WRITE '0xFFFFFFFF' to address '0xMM' of the system registers

#### 6.5.2. R/W access to the MTP

**IMPORTANT NOTE:** Modifications to the MTP are **non-reversible**. Modified parameters will be restored, even after a RESET, and previous values of the MTP cannot be accessed anymore. The maximum number of times the MTP can be written depends on the address:

- 5 times for the acceleration calibration coefficients (not described in this document; please contact Tronic if you need more information about this topic)
- Only 1 time for all the other coefficients, including the temperature sensor calibration coefficients.

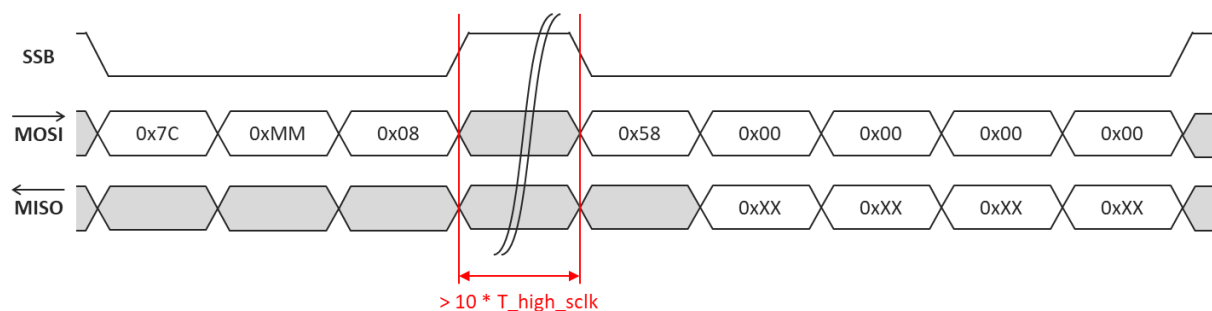

Figure 22: Sequence of instructions to READ address 0xMM of the MTP

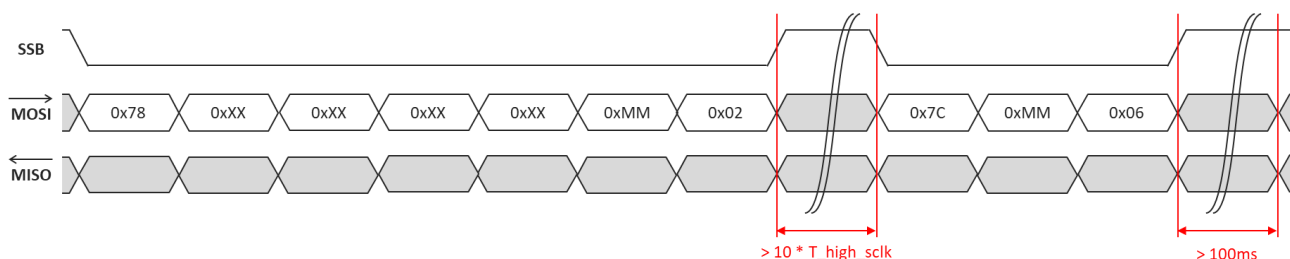

Figure 23: Sequence of instructions to WRITE data '0XXXXXXXX' to address '0xMM' of the MTP

### 6.5.3. Useful Sensor Parameters

The instructions given in Sections 6.5.1 and 6.5.2 can be used to read and/or to modify the sensor's useful parameters given in the table below.

Parameter	Address M (System Register & MTP)	Bits	Encoding	Meaning
<b>Sensor Identification</b>				
UID	0x03	[31:1]	Decimal	Sensor 'Unique Identification' number
<b>Modification of data rate</b>				
ODRSEL	0x61	[7:2]	Binary 0b000001**	From minimum value of 0 [0b000000] to maximum value of 49 [0b110001] - See section 6.6
<b>Temperature output compensation</b>				
TOUT_SEL	0x04	3	0** 1	Disable the calibrated temperature output Enable the calibrated temperature output
O	0x04	[31:18] *	0x0000 ** See section 8	Offset calibration of temperature sensor
G	0x04	[17:4] *	0x0800 ** See section 8	Gain calibration of temperature sensor
<b>Acceleration output compensation</b>				
GOUT_SEL	0x3D	31*	0 1**	Disable the calibrated acceleration output Enable the calibrated acceleration output
MTPSLOTNB	0x3D	[12:8]*	0b00000 0b00001 0b00011 0b00111 0b01111 0b11111	Unprogrammed part Programmed once, 4 slots remaining Programmed twice, 3 slots remaining Programmed 3 times, 2 slots remaining Programmed 4 times, 1 slot remaining Programmed 5 times, no slot remaining
SF4	0x48	[18:0] *	See Table 9	Scale Factor 4th order coefficient (calibrated acceleration)
SF3	0x46	[19:0] *	See Table 9	Scale Factor 3rd order coefficient (calibrated acceleration)
SF2	0x44	[20:0] *	See Table 9	Scale Factor 2nd order coefficient (calibrated acceleration)
SF1	0x42	[29:0] *	See Table 9	Scale Factor 1st order coefficient (calibrated acceleration)
SF0	0x3F	[30:0] *	See Table 9	Scale Factor constant coefficient (calibrated acceleration)
B4	0x47	[18:0] *	See Table 9	Bias 4th order coefficient (calibrated acceleration)
B3	0x45	[19:0] *	See Table 9	Bias 3rd order coefficient (calibrated acceleration)
B2	0x43	[19:0] *	See Table 9	Bias 2nd order coefficient (calibrated acceleration)
B1	0x41	[29:0] *	See Table 9	Bias 1st order coefficient (calibrated acceleration)
B0	0x3E	[23:0] *	See Table 9	Bias constant coefficient (calibrated acceleration)
TMID	0x40	[19:0] *	See Table 9	Mid-temperature calibration point

Table 8: Useful parameters information

Notes:

\* The other bits at those addresses shall remain unchanged. Please make sure that you write them with no modification!

\*\* Default Value

## 6.6. Modification of the data rate

AXO®301 can be used in a wide variety of inertial systems (IMU, INS, AHRS, stabilization platform...) having different data processing capabilities depending on the target application. In order to make sure the output data from the sensors is properly processed at system-level (eg: avoid data overflow on the microcontroller data bus), Tronics provides the capability to increase or decrease the output data rate of AXO®301 product.

The formula below gives the data rate:

$$\text{Data rate [Hz]} = \frac{1900}{\text{ODRSEL} + 1}$$

The default decimal value for ODRSEL is 1 [0b00001] but it can be tuned from 0 (corresponding to a data rate of 1900 Hz) to 49 (data rate of 38 Hz). To tune this parameter, please refer to subsection 6.5.1.

In order to avoid data aliasing and to ensure a reliable vibration rectification error (VRE), we recommend to keep the data rate above 300 Hz, corresponding to ODRSEL = 5.

**IMPORTANT NOTE:** As the default ODRSEL value is already programmed in the OTP and cannot be rewritten, the custom value needs to be loaded in the System Register each time the sensor is powered on.





## 7. Acceleration calibration procedure

### 7.1. Algorithm overview

After filtering, the raw acceleration sensor output is temperature compensated based on the on-chip temperature sensor output and the stored temperature compensation parameters.

#### 7.1.1. Acceleration output calibration model

The formula below models the link between raw and compensated acceleration outputs:

$$ACC[g] = \frac{ACC_{COMP}[LSB]}{SF_{setting}[LSB/g]} = \frac{ACC_{RAW}[LSB] - BIAS[LSB]}{SF[LSB/g]}$$

where:

- ACC is the acceleration output converted in g;
- ACC<sub>COMP</sub> is the calibrated acceleration output;
- SF<sub>setting</sub> is the constant conversion factor from LSB to g for the calibrated acceleration output. Default value for this parameter is SF<sub>setting</sub> = 1 000 000;
- ACC<sub>RAW</sub> is the raw data acceleration output;
- BIAS is a polynomial (4<sup>th</sup> degree) temperature-varying coefficient to model the sensor's bias temperature variations;
- SF is a polynomial (4<sup>th</sup> degree) temperature-varying coefficient to model the sensor's Scale Factor temperature variations.

#### 7.1.2. Recommended procedure

1. Set GOUT\_SEL to 0 in the System Registers (disable the calibration)
2. Place the sensor on a rate table in a thermal chamber and implement temperature profile according to Figure 24<sup>1</sup>
3. Perform continuous acquisition of the acceleration output with the following pattern:
  - Rest position (0g input) to evaluate the BIAS parameter
  - + 1g input then -1g input to evaluate the SF parameter<sup>2</sup>
4. Calculate the coefficients of BIAS and SF polynomials:

$$BIAS = \sum_{i=0}^4 b_i (T_{RAW} - T_{MID})^i$$

$$SF = \sum_{i=0}^4 sf_i (T_{RAW} - T_{MID})^i$$

where

- T<sub>RAW</sub> is the raw output of the temperature sensor **multiplied by 64**;
- T<sub>MID</sub> is the mid-value of T<sub>RAW</sub>;
- b<sub>0</sub> to b<sub>4</sub> are the 5 coefficients of BIAS polynomial;
- sf<sub>0</sub> to sf<sub>4</sub> are the 5 coefficients of SF polynomial.

5. Convert T<sub>MID</sub>, b<sub>i</sub> and sf<sub>i</sub> parameters to their binary values according to Table 9 below:

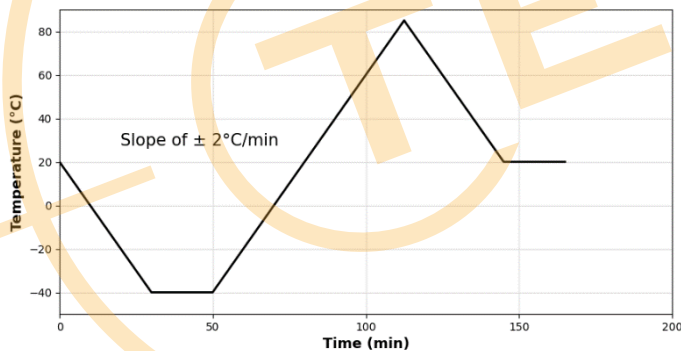

Figure 24: Recommended Temperature profile for calibration

Parameter	Value (decimal)	Format
SF4	sf <sub>4</sub> . 2 <sup>92</sup> / SF <sub>setting</sub>	signed 2's comp
SF3	sf <sub>3</sub> . 2 <sup>72</sup> / SF <sub>setting</sub>	signed 2's comp
SF2	sf <sub>2</sub> . 2 <sup>55</sup> / SF <sub>setting</sub>	signed 2's comp
SF1	sf <sub>1</sub> . 2 <sup>46</sup> / SF <sub>setting</sub>	signed 2's comp
SF0	sf <sub>0</sub> . 2 <sup>27</sup> / SF <sub>setting</sub>	signed 2's comp
B4	b <sub>4</sub> . 2 <sup>73</sup>	signed 2's comp
B3	b <sub>3</sub> . 2 <sup>53</sup>	signed 2's comp
B2	b <sub>2</sub> . 2 <sup>32</sup>	signed 2's comp
B1	b <sub>1</sub> . 2 <sup>20</sup>	signed 2's comp
B0	b <sub>0</sub>	signed 2's comp
TMID	T <sub>MID</sub>	unsigned

Table 9: Acceleration calibration parameters

<sup>1</sup> Temperature profile can be adapted to be in line with customer applications.

<sup>2</sup> Rate applied can be adapted to be in line with customer applications.

## AXO301 Datasheet

### 7.2. Programming of the new coefficients

**IMPORTANT NOTE:** The following steps are **non-reversible**. The previous values of the coefficients will not be accessible anymore. The temperature compensation coefficients can be re-programmed up to 4 additional times on the IC.

The programming procedure consists in three major steps:

- Checking the available MTP slot status
- Programming the coefficients
- Updating the available MTP slot status

An overview of the procedure is given in Figure 25: Procedure to program new calibration parameters.

#### 7.2.1. Checking the MTP slot status

The first step is to check the number of remaining MTP slots (MTPSLOTNB), in other words, checking how many times the chip has been programmed before.

The detailed information of MTPSLOTNB register content is given in Table 8. The sequence of instructions to read the register is given in section 6.5.

The MTP slot number (MTPSLOTNB) re-programming iteration is given in the following table:

Iteration	Correspondence	MTP number	
		Value	Binary
0	Unprogrammed part	0	00000
1	Programmed once	1*	00001
2	Programmed twice	3	00011
3	...	7	00111
4		15	01111
5	Cannot be further programmed	31	11111

Table 10: MTPSLOTNB iterations

\* Default value

#### 7.2.2. Programming the coefficients

This step describes the procedure for programming the calculated coefficients (temperature compensation of acceleration output). The programming procedure is:

1. Write SF4 in the system register
2. Program SF4 in the MTP
3. Write SF3 in the system register
4. Program SF3 in the MTP
5. Write SF2 in the system register
6. Program SF2 in the MTP
7. Write SF1 in the system register
8. Program SF1 in the MTP

9. Write SF0 in the system register
10. Program SF0 in the MTP
11. Write B4 in the system register
12. Program B4 in the MTP
13. Write B3 in the system register
14. Program B3 in the MTP
15. Write B2 in the system register
16. Program B2 in the MTP
17. Write B1 in the system register
18. Program B1 in the MTP
19. Write B0 in the system register
20. Program B0 in the MTP
21. Write TMID in the system register
22. Program TMID

The detailed SPI commands are given in section 6.5. The detailed information about each coefficient is given in Table 8

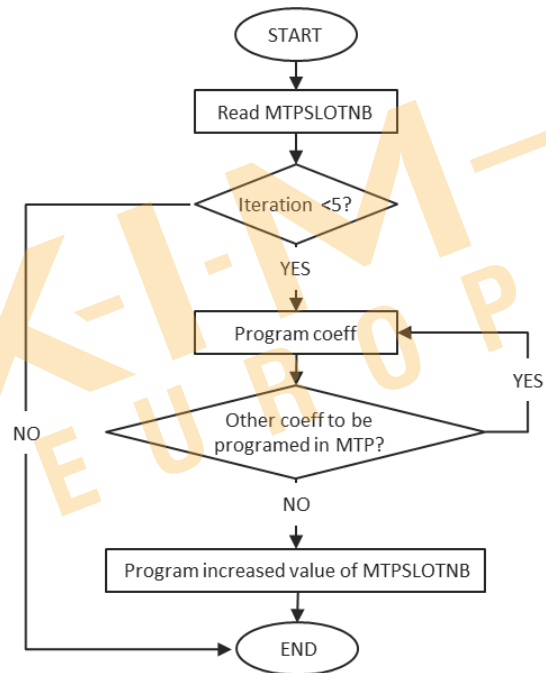

Figure 25: Procedure to program new calibration parameters

#### 7.2.3. Updating MTP slot status

This section describes the procedure for programming the updated status of the MTP slots.

**If this step is not performed properly, the new compensation coefficients will not be effective.**

1. Read the MTPSLOTNB as described in section 6.5.2
2. Increment MTPSLOTNB according to Table 10.
3. Write the updated MTPSLOTNB in the system register.
4. Program the updated MTPSLOTNB in the MTP.
5. After a reset, the new coefficients will be available.

### 7.3. Switch to uncompensated data output

To optimize the thermal compensation of the acceleration output, it is possible to disable the on-chip compensation and use the uncompensated (raw) output to perform an external thermal compensation.

**IMPORTANT NOTE:** This step is **non-reversible**. The previous values of the coefficients will not be accessible anymore.

To switch the acceleration output to uncompensated data, the procedure is exactly the same as described in section 7.2, but the coefficients given in Table 9 must be replaced by the coefficients given below in Table 11.

Parameter	Value (hexadecimal)
SF4	0x0
SF3	0x0
SF2	0x0
SF1	0x0
SF0	0x0800 0000
B4	0x0
B3	0x0
B2	0x0
B1	0x0
B0	0x0
TMID	0x0

Table 11: Acceleration compensation coefficients to obtain raw data

## 8. Temperature Sensor Calibration Procedure

The temperature output of AXO<sup>®</sup>301 sensors is *not* factory-calibrated, since only the raw temperature information is needed by the acceleration calibration blocks. However, it is possible to perform a first-order polynomial calibration of the temperature sensor, in order to output the absolute temperature information.

This section shows how to get and store temperature calibration parameters for the temperature output.

### 8.1. Temperature sensor calibration model

The formula below models the link between raw and calibrated acceleration outputs:

$$T[^{\circ}\text{C}] = \frac{T_{\text{COMP\_OUT}}[\text{LSB}]}{\text{GAIN}_{\text{setting}}[\text{LSB}/^{\circ}\text{C}]} = \frac{\text{GAIN} \cdot T_{\text{RAW}}[\text{LSB}] - \text{OFFSET}[\text{LSB}]}{\text{GAIN}_{\text{setting}}[\text{LSB}/^{\circ}\text{C}]}$$

where:

- **T** is the output temperature converted in  $^{\circ}\text{C}$ ;
- **T<sub>COMP\_OUT</sub>** is the calibrated temperature output;
- **GAIN<sub>setting</sub>** is the constant conversion factor from LSB to  $^{\circ}\text{C}$  for the calibrated temperature output. This gain is set to 85LSB/ $^{\circ}\text{C}$ ;
- **T<sub>RAW</sub>** is the raw data temperature output;
- **OFFSET** is a constant coefficient to tune the offset;
- **GAIN** is a constant coefficient to tune gain.

The **OFFSET** and **GAIN** parameters will be obtained and written in the IC through the following calibration procedure.

### 8.2. Recommended Procedure

1. Check that TOUT\_SEL = 0. If not, set it to 0 in the System Registers.
2. Measure the temperature output with at least 2 temperature points T<sub>1</sub> and T<sub>2</sub>.

3. Calculate the GAIN and OFFSET coefficients according to formula above

$$\text{GAIN} = \text{GAIN}_{\text{setting}} \cdot \frac{T1_{\text{ABS}}[^{\circ}\text{C}] - T2_{\text{ABS}}[^{\circ}\text{C}]}{T1_{\text{RAW}}[\text{LSB}] - T2_{\text{RAW}}[\text{LSB}]}$$

$$\text{OFFSET} = \text{GAIN}_{\text{setting}} \cdot T1_{\text{ABS}}[^{\circ}\text{C}] - \text{GAIN} \cdot T1_{\text{RAW}}[\text{LSB}]$$

where:

- T<sub>1ABS</sub> is the absolute temperature of T<sub>1</sub> in  $^{\circ}\text{C}$ ;
- T<sub>2ABS</sub> is the absolute temperature of T<sub>2</sub> in  $^{\circ}\text{C}$ ;
- T<sub>1RAW</sub> is the raw output temperature of T<sub>1</sub> in LSB;
- T<sub>2RAW</sub> is the raw output temperature of T<sub>2</sub> in LSB;

4. Convert GAIN and OFFSET to their binary values according to Table 12 below:

Parameter	Value (decimal)	Format
G	GAIN . 2 <sup>11</sup>	Unsigned
O	OFFSET	Unsigned

Table 12: Temperature calibration parameters

5. [Optional\_step: Write GAIN and OFFSET in the System Registers and repeat step 2. to check for the new calibration accuracy.]
6. Write GAIN and OFFSET in the MTP according to instructions of Section 6.5.2. Meanwhile, set TOUT\_SEL to 1 during this step, so that the new calibration parameters are effective after a RESET.

## 9. Device Identification

### 9.1. Device information

AXO®301 tracking information is accessible on the label, as shown in the next figure.

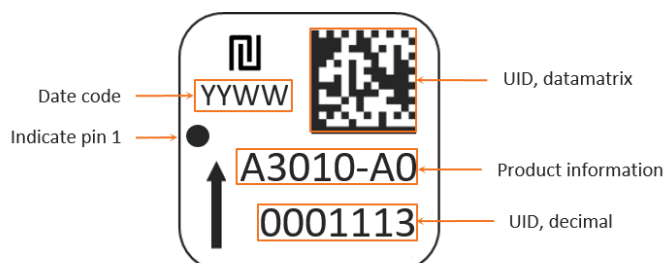

Figure 26: AXO®301 label

### 9.2. Ordering information

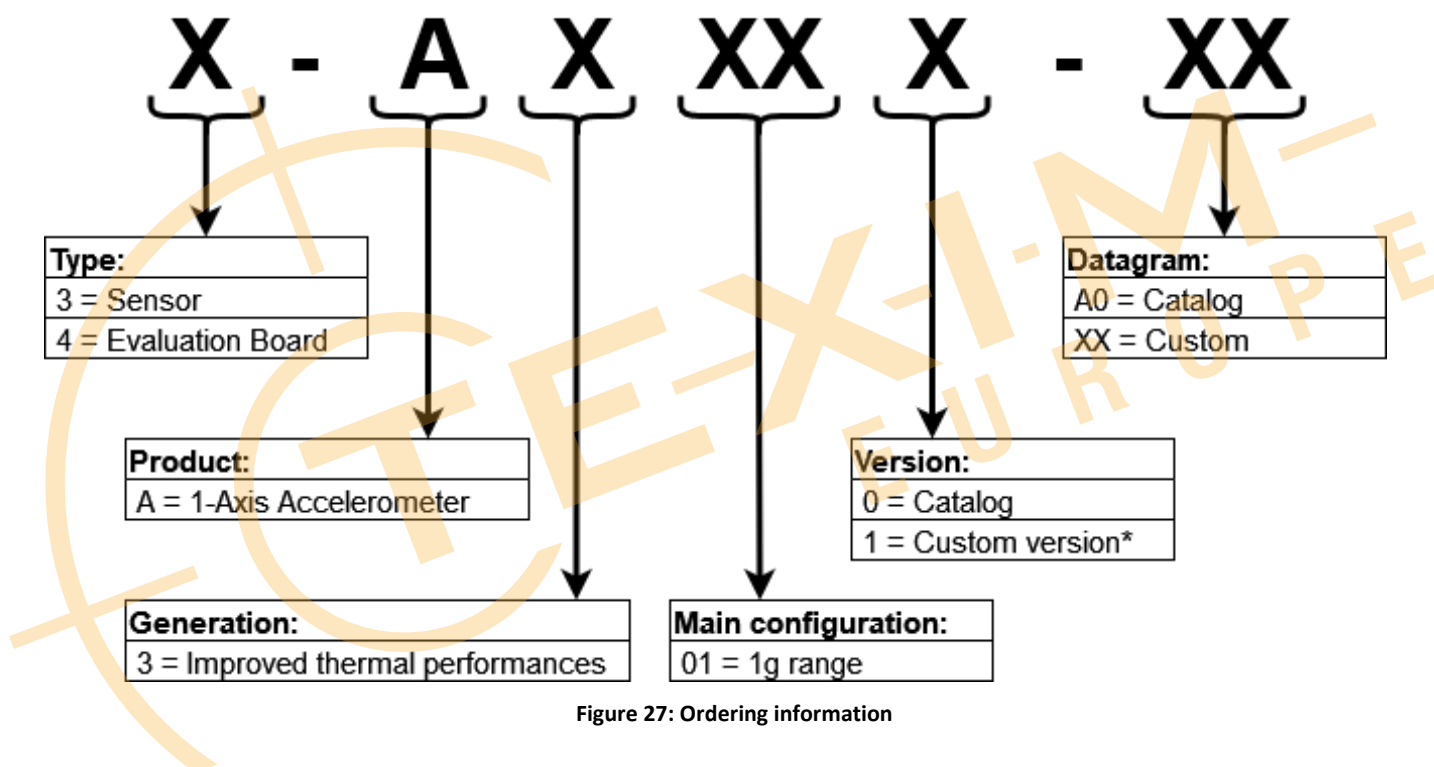

Figure 27: Ordering information

\* Custom version or specific requirement can be addressed upon request.

Product	Ordering code
AXO301	3-A3010-A0
AXO301-EVB3	4-A3010-A0

Table 13: Product ordering code

## 10. Internal construction and Theory of Operation

AXO301 sensor is using the dominant architecture for high performance MEMS accelerometers, namely the "In-plane Force-rebalance" design. A symmetric silicon proof mass is suspended by pairs of opposing spring flexures on either side of the proof mass. An applied acceleration acts on the proof mass. This in-plane motion is counterbalanced by applying voltages that generate electrostatic forces to rebalance the proof mass (closed-loop operation). The applied voltage is directly proportional to the input acceleration.

In details, each sensor consists in a MEMS transducer and an integrated circuit (IC) packaged in a 28-pins J-leaded Ceramic Package.

The MEMS transducer is manufactured using Tronic's hermetic wafer-level packaging technology where the microstructure is micro-machined thick single crystal silicon for its mechanical reliability.

The MEMS die is located on the left part of the block diagram. Differential detection and actuation are used for efficient common mode rejection. The sensor is factory calibrated and compensated for temperature effects to provide high-accuracy digital output over a broad temperature range.

Raw data output can be also chosen to enable customer-made compensations.

The IC is located on the right part of the block diagram. The IC is designed to interface the MEMS sensing element. It is fully hard-coded and includes no firmware or software. Its 24-bit digital SPI output suppresses the need for costly high resolution A/D converter at the systems level.

It includes ultra-low noise capacitive to voltage converters (C2V) followed by high resolution voltage digitization (ADC). Excitation voltage required for capacitance sensing circuits is generated on the common electrode node. 1-bit force feedbacks (DAC) are used for electrostatic actuation.

The digital part implements digital control loop and processes the acceleration output based on the on-chip temperature sensor output. The system controller manages the interface between the SPI registers, the system register and the non-volatile memory (OTP). The non-volatile memory provides the accelerometer settings, in particular the coefficients for acceleration temperature compensation. On power up, the settings are transferred from the OTP to the system registers and output data are available in the SPI registers. The acceleration output and the temperature sensor output are available in the SPI registers. The SPI registers are available through the SPI interface (SSB, SCK, MOSI, MISO). The self-test and the data ready are available respectively on the external pin ST and DRY.

The "References" block generates the required biasing currents and voltages for all blocks as well as the low-noise reference voltage for critical blocks.

The "Power Management" block manages the power supply of the sensor from a single 5V supply between the VDD and GND pins. It includes a power on reset as well as an external reset pin (RSTB) to start or restart operation using default configuration. An enable pin (EN) with power-down capability is also available.

The sensor is powered with a single 5V DC power supply through pins VDD and GND. Although the sensor contains three separate VDD pins, the sensor is supplied by a single 5V voltage source. It is recommended to supply the three VDD pins in a star connection with appropriate decoupling capacitors. Regarding the sensor grounds, all the GND pins are internally shorted. The GND pins redundancy is used for multiple bonds in order to reduce the total ground inductance. It is therefore recommended to connect all the GND pins to the ground.

## 11. Available Tools and Resources

The following tools and resources are available on the AXO® product page of our [website](#).









Item	Description
<b>Documentation &amp; technical notes</b>	
	<b>AXO301 - Datasheet</b>
<b>Mechanical tool</b>	
	<b>3D model</b>
<b>Evaluation kit</b>	
	<b>Tronics EVB3 – Evaluation board</b> <i>Evaluation board for AXO301, compatible with Arduino Leonardo</i>
	<b>Tronics Evaluation Tool – Software</b>
	<b>Tronics EVB3 – User manual</b>
	<b>Tronics Evaluation Kit – Quick Start Guide</b>
	<b>Tronics Evaluation Tool – Software User Manual</b>
	<b>Tronics Evaluation Tool – Arduino Firmware</b>

Table 14: Available tools and resources

## 12. Revision History

Item	Datasheet MCD034-C/MCD034-D
Product life cycle update	Product maturity from Serial Samples to Production
Bias Instability (Allan Variance)	Nominal value changed
Bias in-run (short term) stability	Max value changed
Bias long term stability	Nominal value changed
1 year composite scale factor repeatability	Nominal value changed
Residual scale factor temperature error	Nominal value changed
Scale factor long term stability	Nominal value changed
Noise density	Nominal value changed
Velocity Random Walk (VRW)	Nominal value changed

Item	Datasheet MCD034-B/MCD034-C
SPI timing diagram	Correction of SPI timing diagram (SPI mode 0)