

# UVLS-GM2-AR0822

- onsemi AR0822 8MP Rolling Shutter Sensor
- 4K HDR Imaging Capabilities
- Near Infra-Red Enhancement for Outdoor Applications
- Designed for Low Light Applications
- S-Mount for Interchangeable Lenses
- GMSL2™ (Gigabit Multimedia Serial Link) interface
- FAKRA Z-Code Automotive Connector
- Plug & Play with Linux OS & Yocto
- VizionViewer™ configuration utility
- VizionSDK for custom development

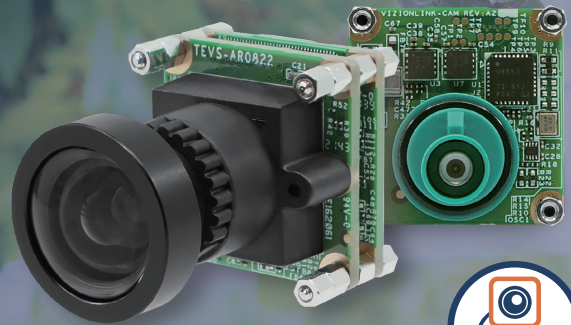

Distributed by:

[www.texim-europe.com](http://www.texim-europe.com)

## Camera Information

CMOS Sensor	onsemi AR0822
Active Pixels	3840 (H) x 2160 (V) = 8 MP
Pixel Size	2.0 µm x 2.0 µm
Illuminated Type	Back Side Illuminated (BSI)
Maximum S/N Ratio	40.5 dB
Optical Format	1/2" (Diagonal 8.81 mm)
Shutter Type	Rolling Shutter
Chromaticity	Color / Mono
HDR Support	Yes
Maximum Frame Rate (YUV422-UYYV)	3840 x 2160 @ 15 fps 2560 x 1440 @ 30 fps 1920 x 1080 @ 60 fps 1280 x 720 @ 60 fps 640 x 480 @ 60 fps
Output Format	YUV422-UYYV RGB888 / RGB565 RAW8 / RAW10 / RAW12

## Camera Interface

Serial Link	GMSL2
Serializer	MAX96717
Connector	FAKRA SMB Jack Z-Code

## Power

Power over Coax	10.8V - 26.4V
Power Consumption	3840 x 2160 @ 15 fps ≤ 1.3W
Standby Power	≤ 0.1W Standby

## Software Support

Platform Support	NVIDIA Jetson AGX Orin NVIDIA Jetson Orin Nano / NX NVIDIA Jetson Xavier NX NVIDIA Jetson Nano NXP i.MX95
Operation System	Linux Yocto
Software	VizionViewer™
Development SDK	VizionSDK



VizionSDK



VizionViewer™

## Environmental and Mechanical

Dimensions	24.5(W) x 24.5(H) x 34.4(D) mm
Weight	≤ 25 grams
Operating Temperature	-30°C to + 70°C

## Certification and Compliance

Certification	Compliant with CE / FCC / RoHS / REACH directives
---------------	---

## Spectral Characteristics

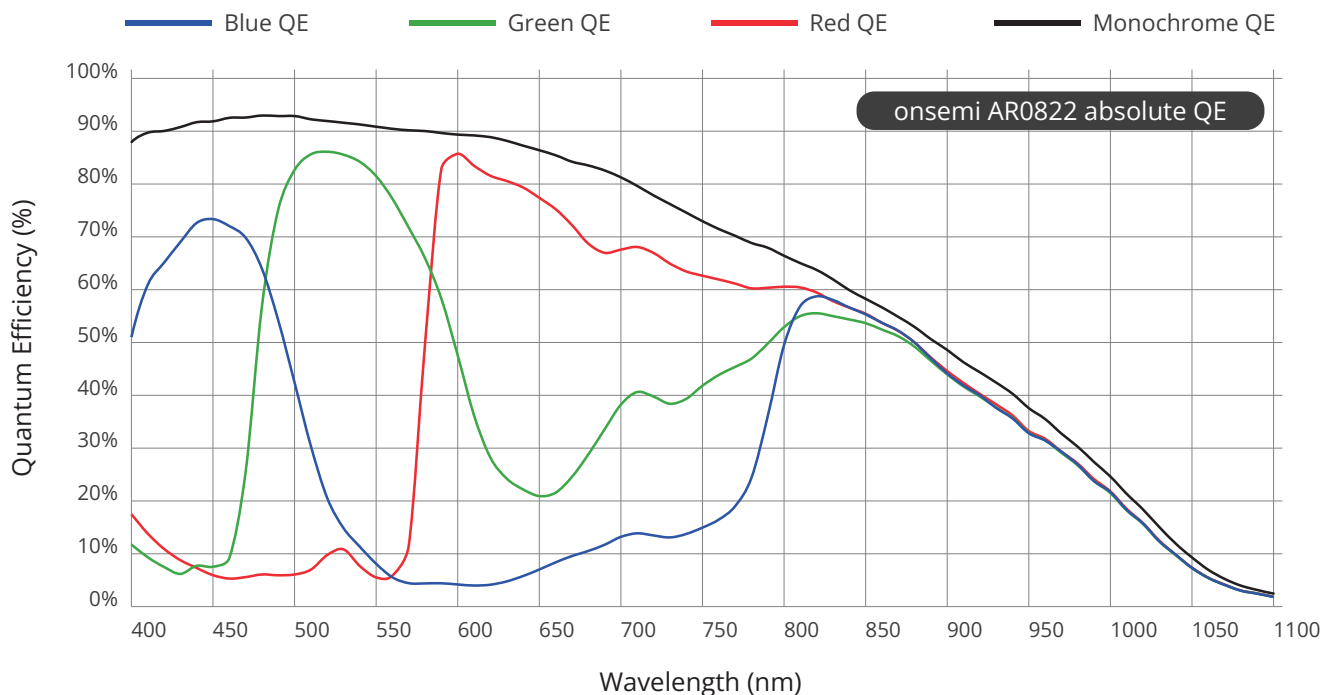

## Block Diagram

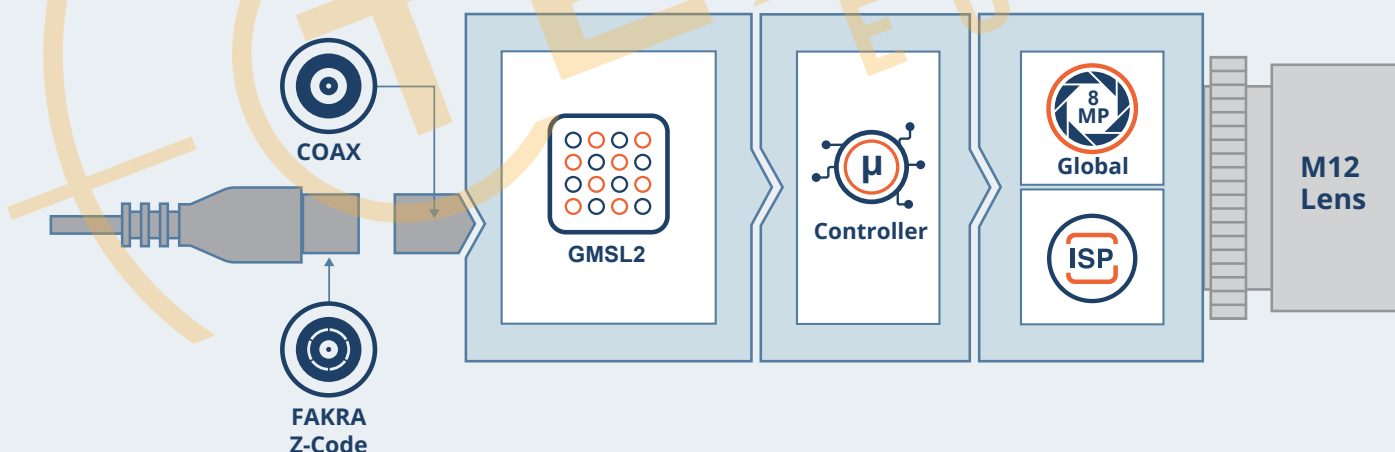

## Dimensions (units in mm)

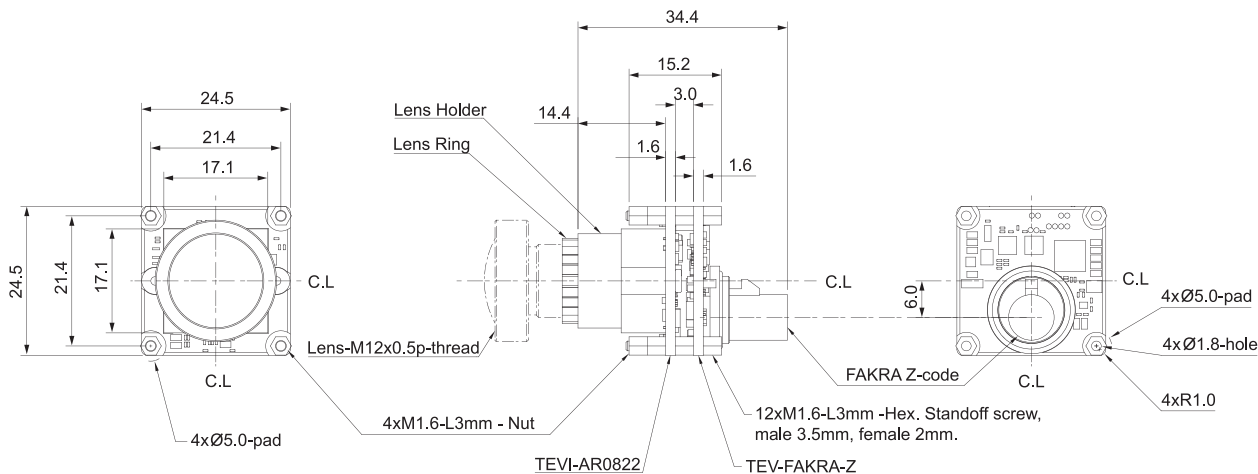

## Order Information

UVLS-GM2-AR0822-x-Sxx-xx-xxxx

Option	Code	Description
Chromaticity	C	Color
	M	Monochrome
Lens	S42	S-Mount Module D-FOV 42°
	S72	S-Mount Module D-FOV 72°
	S108	S-Mount Module D-FOV 108°
	S150	S-Mount Module D-FOV 150°
Filter	-	-
	IR	IR Cut Filter 650nm
Custom ID	xxxx	Custom Part number ID for customized Software loader and special component (BOM)

For customization, please contact your TechNexion sales representative.

## Optional Accessories

An easy to attach A-Mount bracket for TechNexion 30mm enclosed cameras.







245-MOUNT-BRACKET



245-MOUNT-BRACKET on tripod (tripod not included)

## Custom Lens Solutions

				
	UVLS-GM2-AR0822-C-S42-IR	UVLS-GM2-AR0822-C-S72-IR	UVLS-GM2-AR0822-C-S108-IR	UVLS-GM2-AR0822-C-S150-IR
Focus Type	Fixed Focus	Fixed Focus	Fixed Focus	Fixed Focus
Focal Length	12 mm	6 mm	3 mm	3.2 mm
Aperture	F2.0	F2.8	F2.0	F2.0
Module D-FOV	41.7° ± 5%	72.0° ± 5%	108.6° ± 5%	150.0° ± 5%
Module H-FOV	36.3° ± 5%	64.7° ± 5%	104.0° ± 5%	132.6° ± 5%
Module V-FOV	20.5° ± 5%	39.0° ± 5%	72.2° ± 5%	77.6° ± 5%
TTL	23.09 mm	28.6 mm	29.56 mm	44.98 mm
BFL	5.06 mm	8.8 mm	4.85 mm	6.14 mm
MOD	0.15 m	0.1 m	0.3 m	0.3 m
Distortion	<2%	<0.50%	<-5%	<-32%
IR-Filter	650 nm	650 nm	650 nm	650 nm

## GMSL2 Frame Grabbers

The ease of usage, benefits and integration of a GMSL camera in embedded systems is often made complex by the lack of GMSL ports and connectors on the system. For those scenarios TechNexion developed a range of framegrabbers that easily plug into a USB port and extend the system with 1 to 4 GMSL interconnects.



### 1-4 Port

Connect up-to 4 GMSL cameras to a single USB port on your x86 or Arm based system.



### UVC Compliant

Fully plug-n-play in Windows and Linux embedded systems.



### Autodetect

Zero configuration required to detect any specific TechNexion GMSL camera by the framegrabber.



### Software

Linux and Windows systems are supported.



### VizionViewer™

Easy to use software utility providing you with granular camera settings control.



### VizionSDK

Hardcode and control your cameras with C# and Python code.



## **Disclaimer**

ALL PRODUCTS, PRODUCT SPECIFICATIONS AND DATA ARE SUBJECT TO CHANGE WITHOUT NOTICE TO IMPROVE RELIABILITY, FUNCTION OR DESIGN OR OTHERWISE.

Texim Europe B.V. its affiliates, agents, and employees, and all persons acting on its or their behalf (collectively, "Texim"), disclaim any and all liability for any errors, inaccuracies or incompleteness contained in any datasheet or in any other disclosure relating to any product.

Texim makes no warranty, representation or guarantee regarding the suitability of the products for any particular purpose or the continuing production of any product.

It is the customer's responsibility to validate that a particular product with the properties described in the product specification is suitable for use in a particular application.

Parameters provided in datasheets and / or specifications may vary in different applications and performance may vary over time.

All operating parameters, including typical parameters, must be validated for each customer application by the customer's technical experts.

Please contact us if you have any questions about the contents of the datasheet.

This may not be the latest version of the datasheet. Please check with us if a later version is available.

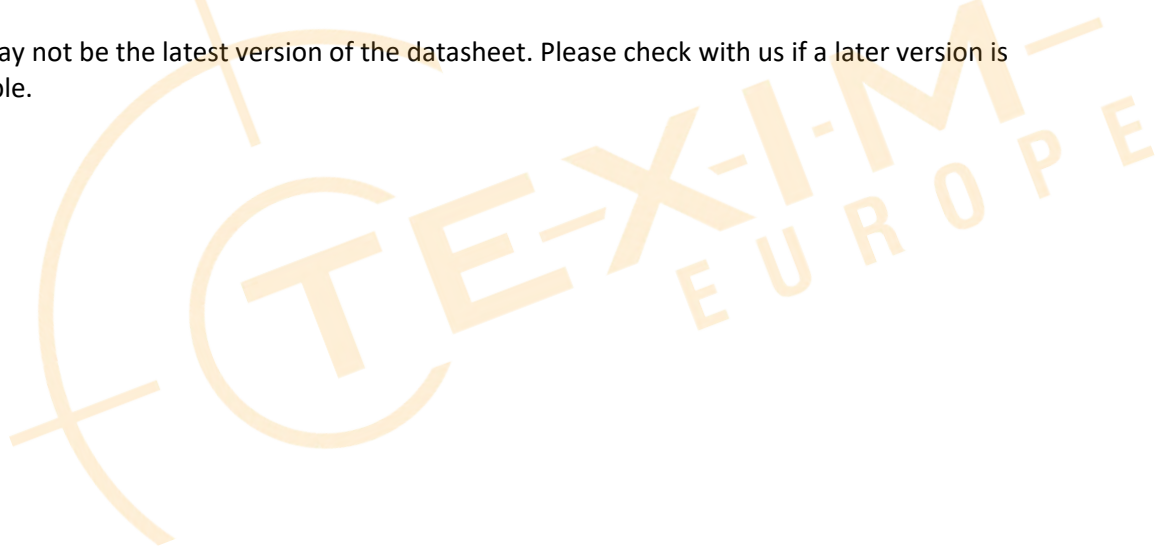



## Headquarters & Warehouse

Elektrostraat 17  
 NL-7483 PG Haaksbergen  
 The Netherlands

T: +31 (0)53 573 33 33  
 E: info@texim-europe.com  
 Homepage: www.texim-europe.com



### The Netherlands

Elektrostraat 17  
 NL-7483 PG Haaksbergen

T: +31 (0)53 573 33 33  
 E: nl@texim-europe.com



### Belgium

Zuiderlaan 14, box 10  
 B-1731 Zellik

T: +32 (0)2 462 01 00  
 E: belgium@texim-europe.com



### UK & Ireland

St Mary's House, Church Lane  
 Carlton Le Moorland  
 Lincoln LN5 9HS

T: +44 (0)1522 789 555  
 E: uk@texim-europe.com



### Germany

Bahnhofstrasse 92  
 D-25451 Quickborn

T: +49 (0)4106 627 07-0  
 E: germany@texim-europe.com



### Germany

Martin-Kollar-Strasse 9  
 D-81829 München

T: +49 (0)89 436 086-0  
 E: muenchen@texim-europe.com



### Austria

Warwitzstrasse 9  
 A-5020 Salzburg

T: +43 (0)662 216 026  
 E: austria@texim-europe.com



### Nordic

Stockholmsgade 45  
 2100 Copenhagen

T: +45 88 20 26 30  
 E: nordic@texim-europe.com



### Italy

Martin-Kollar-Strasse 9  
 D-81829 München

T: +49 (0)89 436 086-0  
 E: italy@texim-europe.com