

AXO®305 – High performance ± 5 g closed-loop MEMS accelerometer with digital interface.

Key Performances

- ± 5 g input range single-axis accelerometer
- Bandwidth: >120 Hz (configurable upon request)
- Scale factor nonlinearity: 50 ppm
- 1-year composite bias repeatability: 1 mg
- Composite scale factor repeatability: 1000 ppm
- Vibration rejection: 20 $\mu\text{g}/\text{g}^2$
- Noise density: 10 $\mu\text{g}/\sqrt{\text{Hz}}$
- Temperature range: -40°C to $+85^\circ\text{C}$



Key Features

- 24-bit digital SPI interface
- Initial and continuous self-test
- Factory-calibrated over temperature
- Hermetic ceramic SMD 28 pins J-LEAD package
- Non classified under dual-use export control
- REACH and RoHS compliant

Applications

- IMU and INS for GNSS-assisted navigation of manned and unmanned ground vehicles
- MRU for ship motion control and dynamic positioning
- Platform, antenna, and crane stabilization
- Motion control of underwater vehicles
- IMU and INS for navigation of AUV and ROV
- IMU / INS for GNSS-assisted train positioning and navigation
- IMU for precision robotics

General Description

AXO®305 is a single-axis, high performance and low noise, closed-loop MEMS accelerometer with ± 5 g input range that offers a digital and cost-effective alternative to quartz accelerometers at a fraction of their size, weight, and power consumption.

Its superior 1-year composite bias repeatability of 1 mg makes AXO®305 a perfect candidate for integration into IMU, INS and MRU for land, railway, marine and subsea applications.

The 24-bit digital SPI interface eases the integration of AXO®305 at system-level while the built-in self-test ensures initial verification of the sensor's integrity and continuous in-operation functionality test.

AXO®305 is free from dual-use export control, as well as REACH and RoHS compliant. AXO®305 sensors are factory calibrated and compensated for temperature effects to provide high-accuracy digital output. Raw data output can be also chosen to enable customer-made compensations.

Disclaimer

Information furnished by Tronics is believed to be accurate and reliable. However, no responsibility is assumed by Tronics for its use, nor for any infringements of patents or other rights of third parties that may result from its use.

Specification subject to change without notice.

No license is granted by implication or otherwise under any patent or patent rights of Tronics. Trademarks and registered trademarks are the property of their respective owner.

Contents

1. Specifications	4
2. Absolute Maximum Ratings	6
3. Typical Characteristics	7
4. Interface	9
4.1. Pinout, sensitive axis identification	9
4.2. Application circuit	9
4.3. Input/Output Pin Definitions	10
5. Soldering Recommendations	11
6. Digital SPI Interface	12
6.1. Electrical and Timing Characteristics	12
6.2. SPI frames description	13
6.3. Acceleration readings	13
6.3.1. Acceleration (ACC) output	13
6.3.2. Data Ready (DRY) bit	13
6.3.3. Self-Test (ST) bit	13
6.4. Temperature readings	13
6.5. Advanced use of SPI registers	14
6.5.1. R/W access to the System Registers	14
6.5.2. R/W access to the MTP	14
6.5.3. Useful Sensor Parameters	15
6.6. Modification of the data rate	16
7. Acceleration calibration procedure	17
7.1. Algorithm overview	17
7.1.1. Acceleration calibration model	17
7.1.2. Recommended procedure	17
7.2. Programming of the new coefficients	18
7.2.1. Checking the MTP slot status	18
7.2.2. Programming the coefficients	18
7.2.3. Updating MTP slot status	18
7.3. Switch to uncompensated data output	19
8. Temperature Sensor Calibration Procedure	20
8.1. Temperature sensor calibration model	20
8.2. Recommended Procedure	20
9. Device Identification / Ordering information	21
9.1. Device identification	21
9.2. Ordering information	21
10. Internal construction and Theory of Operation	22
11. Available Tools and Resources	23
12. Revision History	24

Block diagram

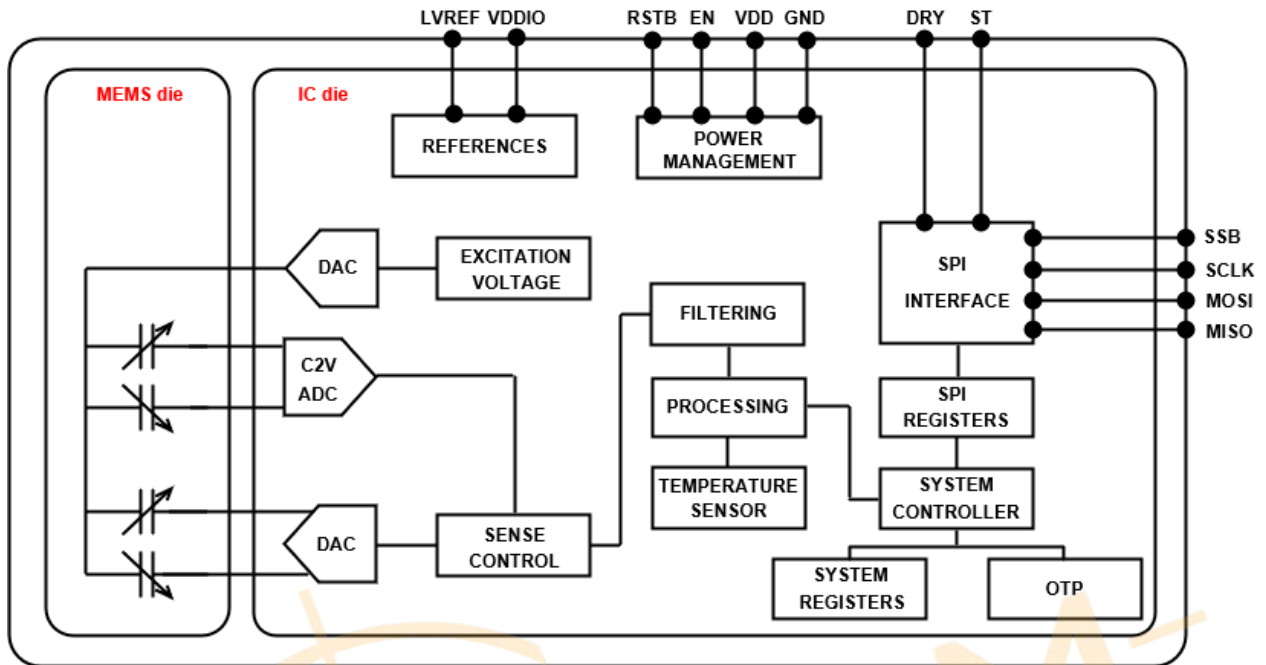

Figure 1 : Block Diagram

Overall Dimensions (with MEMS transducer gravity center in blue)

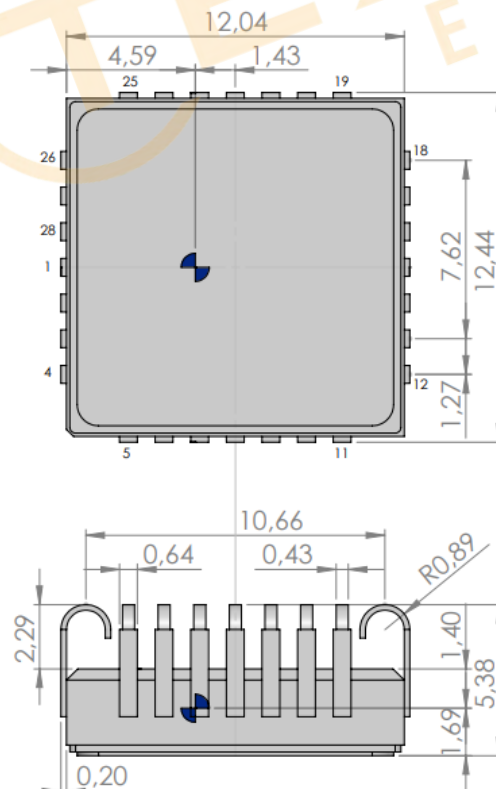

Figure 2 : Overall dimensions

1. Specifications

Parameter	Unit	Min	Nom	Max ⁽²⁾	Notes
Measurement Ranges					
Input range ⁽¹⁾	g		±5		Clamping is applied, sensors will saturate before ±7g
Temperature range ⁽¹⁾	°C	-40		+85	
Bias					
1 year composite bias repeatability	mg		1		Total bias drift per year, quadratic sum of all bias errors
Bias instability ⁽¹⁾	µg		3	15	Lowest point of Allan variance curve at room temperature
Bias in-run (short term) stability	µg		15	45	Standard deviation of the 1 second filtered output over 1 hour at room temperature, after 30 min of stabilization
Residual Bias Temperature Error (1σ), calibrated ⁽¹⁾⁽³⁾⁽⁵⁾	mg		0.5	1.5	Maximum variation of the bias over the specified temperature range after 4 th order calibration
Bias repeatability	µg		220		See note ⁽⁴⁾
Bias long term stability	mg		0.14		Drift per year, based on Allan variance extrapolation
Warm-up bias drift	µg		50		Bias drift during initial sensor self-heating after power on at 0g
Vibration Rectification Error (VRE)	µg/g ²		20		Bias rectification under operating vibrations; root mean square of all axis
Scale Factor					
Scale factor ⁽¹⁾	LSB/g		1 000 000		Nominal scale factor
1 year composite scale factor repeatability	ppm		1000		Total scale factor drift per year, quadratic sum of all scale factor errors
Residual scale factor temperature error, calibrated ⁽¹⁾⁽³⁾	ppm		500	1000	Maximum variation of the scale factor over the specified temperature range after 4 th order calibration
Scale factor repeatability	ppm		280		See note ⁽⁴⁾
Scale factor long term stability	ppm		700		Drift per year, based on Allan variance extrapolation
Linearity, Noise					
Non linearity ⁽¹⁾	ppm		50	350	Maximum deviation of the output from the expected value using a best fit straight line over the [0g ; 5g] range, at room temperature
Noise density ⁽¹⁾	µg/√Hz		10		Over the full bandwidth, at room temp.
Velocity Random Walk (VRW)	m/s/√h		0.005		-1/2 slope tangent, based on Allan Variance at 1s
Frequency response					
Bandwidth	Hz		150		Defined as the frequency for which attenuation is equal to -3dB
Data Rate (DR)	Hz		2500		Refresh rate of the output data at room temperature
Latency	ms		2		Time delay between the physical acceleration (input) and the output signal
Start-up time ⁽⁶⁾	ms		400		Time interval between application of power on and the availability of an output signal (at least 90% of the input rate), at room temperature

Parameter	Unit	Min	Nom	Max(2)	Notes
Axis alignment					
Axis misalignment	mrad			20	By design
Environmental					
Device Weight	gram		1.5		
Storage temperature range	°C	-55		+125	
Component shelf life	Years		5		
Humidity at 45°C	%			98	
Moisture Sensitivity Level (MSL)	--		1		Unlimited floor life out of the bag (hermetic package)
Shock (operating)	g ms		50 6		Half sine
Shock (survival)	g ms		2000 0.3		
Vibrations (operating)	g _{rms}		4.12		DO-160G standard, curve C
Vibrations (survival)	g _{rms}		20		
Electrical					
Power Supply Voltage	V	4.75	5.00	5.25	
Current consumption (normal mode)	mA		25		
Current consumption (power down mode)	µA		1	5	Power down mode is activated by switching EN pin to GND
Power supply rejection ratio	µg /V		130		
Temperature sensor					
Scale Factor (raw data)	LSB/°C		85		Temperature sensor is not factory-calibrated
25°C typical output (raw data)	LSB		8000		Temperature sensor is not factory-calibrated
Refresh rate	Hz		6		
Reliability					
MTBF	hours		≥ 1000 000		Predictive elapsed time between inherent failures of the sensor during normal system operation for 50°C use temperature

Table 1: Specifications

⁽¹⁾ 100% tested in production

⁽²⁾ Unless otherwise specified, max values are ±3 sigma variation limits from validation test population

⁽³⁾ Temperature range of -40°C to +85°C

⁽⁴⁾ Bias and scale factor repeatabilities include the following parameters:

- Turn On to Turn Off repeatability at constant temperature and constant accelerations
- Repeatability over temperature, at constant acceleration
- Repeatability over acceleration, at constant temperature
- Day to day repeatability, over ten days

⁽⁵⁾ Due to the sigma delta architecture, there is a dead band of 200µg around zero input level.

⁽⁶⁾ Startup guaranteed at -20°C. Applications requiring start at temperature below -20°C require dedicated integration constraints and/or specific product configuration. Please contact us for more information

IMPORTANT NOTE: Achieving optimal performance is dependent on following the prescribed integration guidelines, specifically soldering method and mechanical integration. Please contact our support team at support.tronics@tdk.com to obtain our application note.

2. Absolute Maximum Ratings

Stresses at or exceeding the maximum ratings listed below may cause permanent damage to the device or affect its reliability. Exposure to maximum ratings conditions for extended periods may also affect device reliability.

Functional operation is not guaranteed once stresses exceeding the maximum ratings have been applied.

Parameter	Unit	Min	Max
Supply Voltage	V	-0.5	+7
Electrostatic Discharge (ESD) protection, any pin, Human Body Model	kV	--	±2
Storage temperature range	°C	-55	+125
Shock survival	g	--	2000
Vibrations survival, 20-2000Hz	g _{rms}	--	20
Ultrasonic cleaning		Not allowed	

Table 2: Absolute Maximum ratings

Caution!



The product may be damaged by ESD, which can cause performance degradation or device failure! We recommend handling the device only on a static safe workstation. Precaution for the storage should also be taken.



The sensor **MUST** be powered-on *before* any SPI operation, as shown in Figure 3 below. Having the SPI pins, VDDIO or EN at a high level while VDD is at a low level could damage the sensor, due to ESD protection diodes and buffers.



Sensor product stresses at or above those listed under Table 2 Maximum ratings, may cause permanent damage and may affect product reliability.

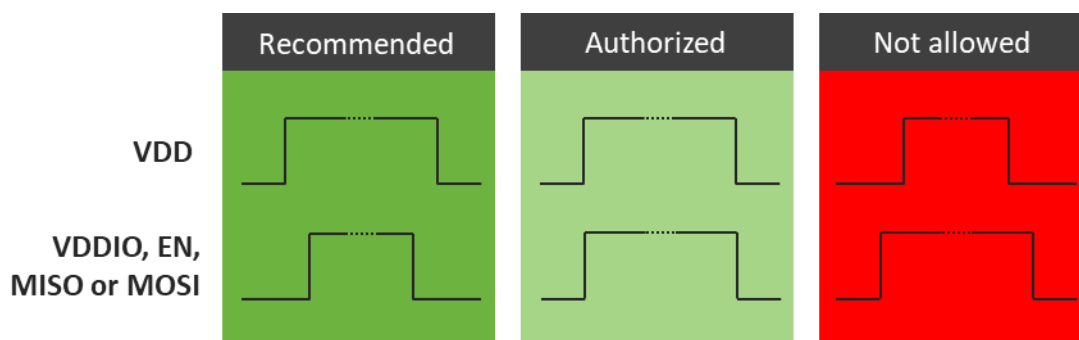

Figure 3: Recommended voltage sequence

3. Typical Characteristics

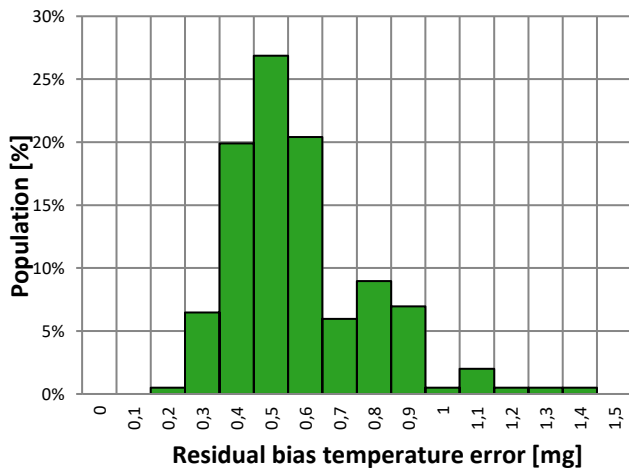

Figure 4: Distribution of bias over temperature

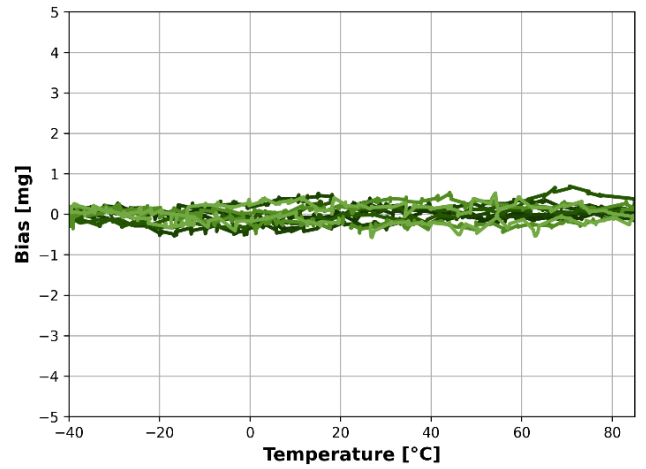

Figure 7 : Residual bias temperature error (5 samples)

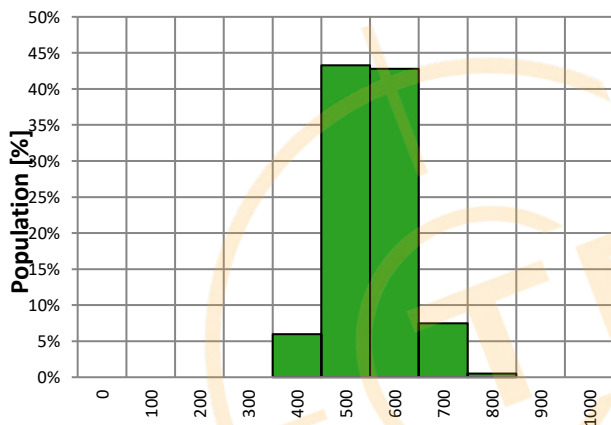

Figure 5: Distribution of scale factor over temperature

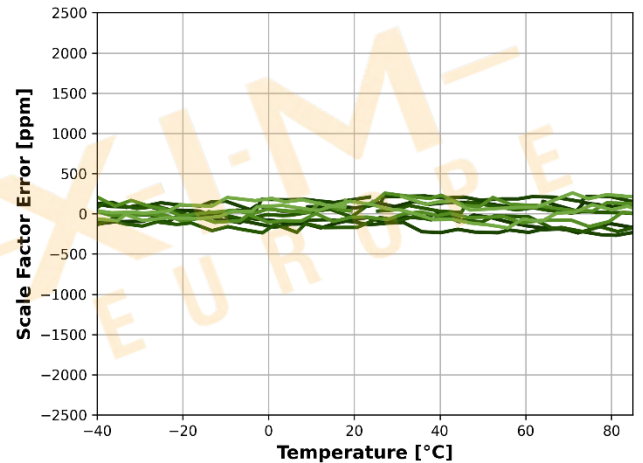

Figure 8: Residual scale factor error (5 samples)

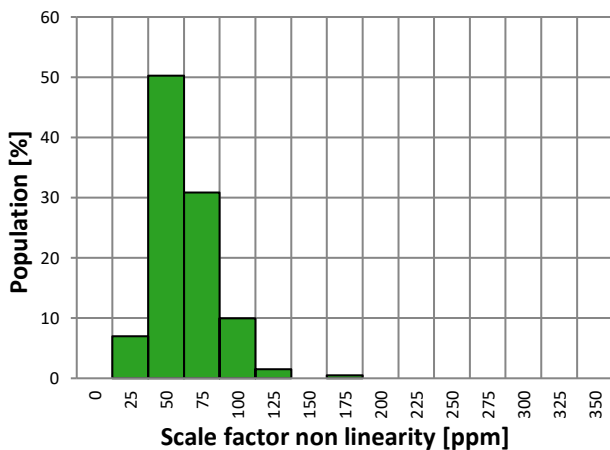

Figure 6: Scale Factor non linearity distribution (room temperature)

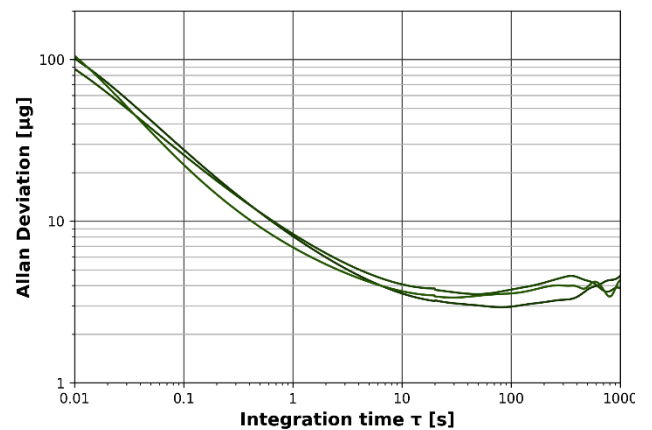

Figure 9: Allan variance (5 samples at 35°C)

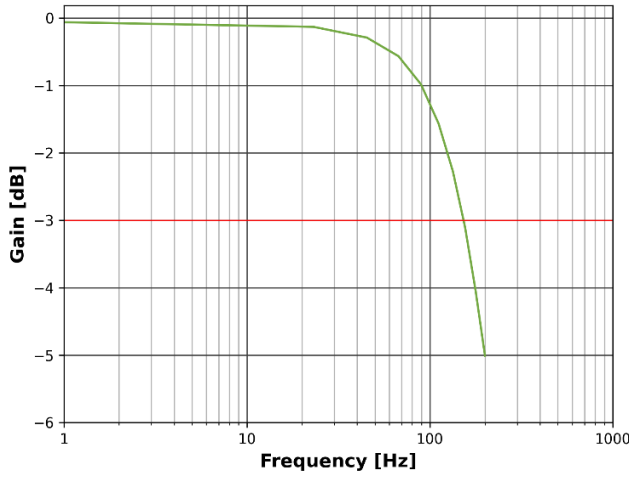

Figure 11: Frequency response

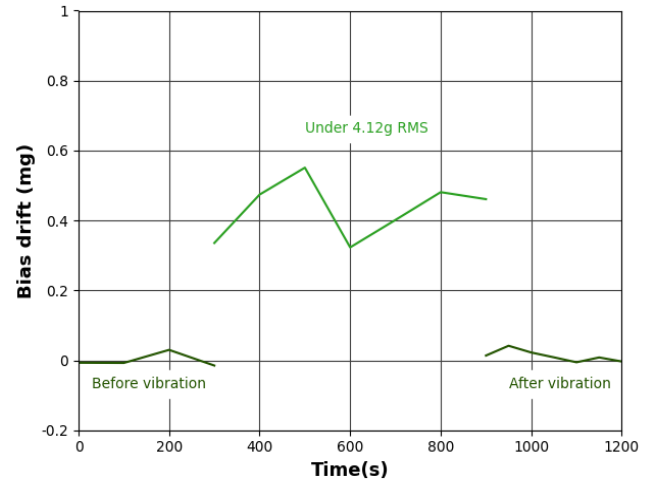

Figure 10: Bias drift under vibration

(4.12 g RMS profile, root mean square of all axes)

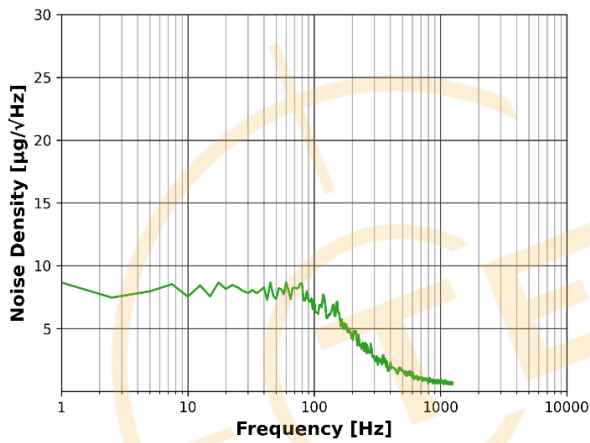

Figure 12: Noise density (room temperature)

4. Interface

4.1. Pinout, sensitive axis identification

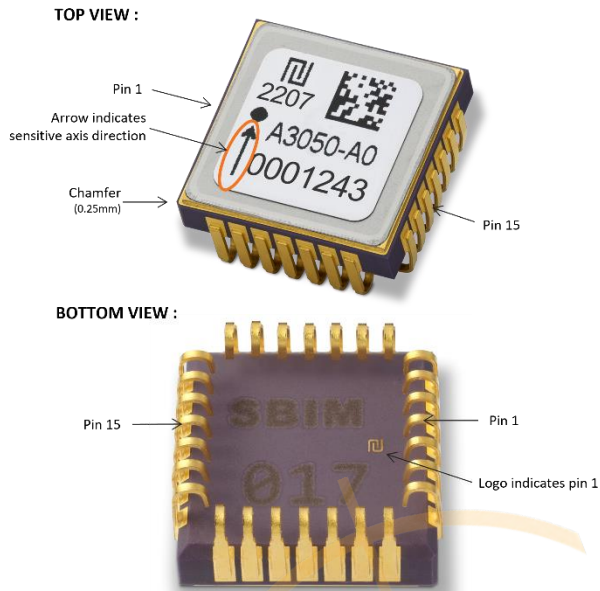

Figure 13: How to locate Pin 1 and Sensitive Axis

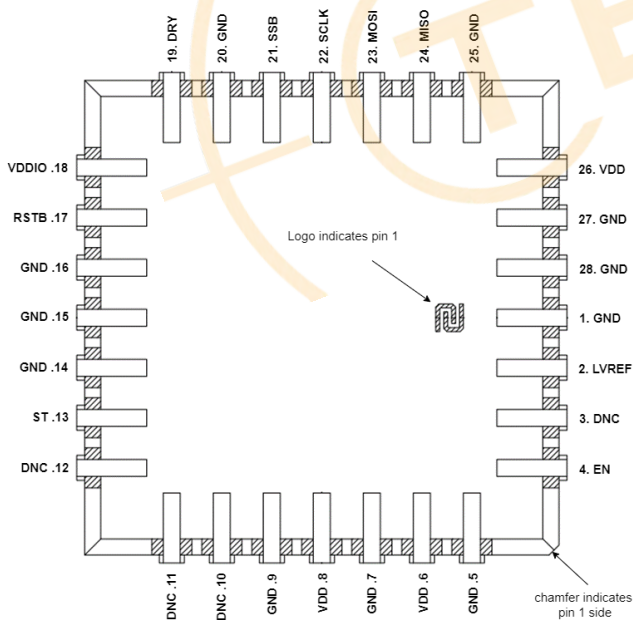

Figure 14: AXO305 Sensors Pinout (bottom view)

4.2. Application circuit

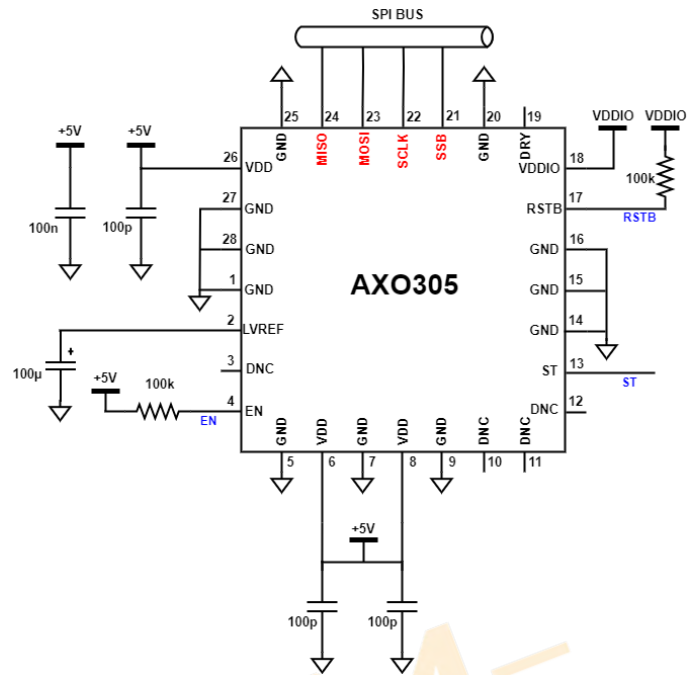

Figure 15: Recommended Application Schematic

Notes:

- All capacitances of Figure 15 should be placed as close as possible to their corresponding pins, except the 100nF capacitance between VDD and GND, which should be as close as possible to the board's supply input.
- The 100µF filtering capacitance between LVREF and GND should have low Equivalent Series Resistance (ESR < 1Ω) and low leakage current (< 6µA). A tantalum capacitor is recommended.
- The digital pins maximum ratings are GND-0.3V and VDD+0.3V.

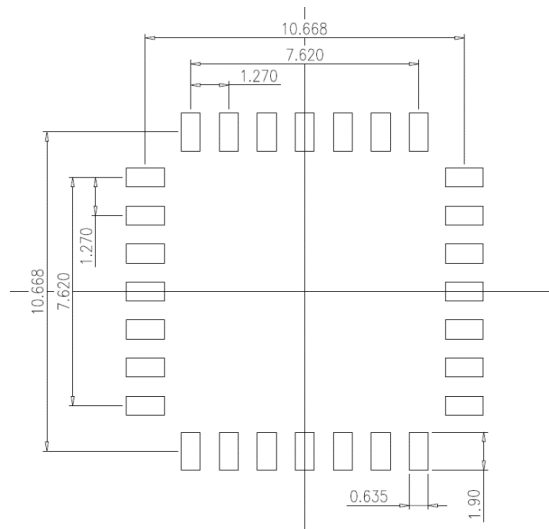

Figure 16: Recommended Pad Layout in mm (dimensions in mm)

4.3. Input/Output Pin Definitions

Pin name	Pin number	Pin type	Pin direction	Pin levels	Function
GND	1, 5, 7, 9, 14, 15, 16, 20, 25, 27,28	Supply	n/a	0V	Power Ground
VDD	6, 8, 26	Supply	n/a	+5V	Power Supply
MISO	24	Digital	Output	VDDIO	Master Input Slave Output signal
MOSI	23	Digital	Input	VDDIO	Master Output Slave Input signal
SCLK	22	Digital	Input	VDDIO	SPI clock signal
SSB	21	Digital	Input	VDDIO	Slave Selection signal. SPI Setup at falling Edges
DRY	19	Digital	Output	VDDIO	Data Ready flag. Generates a pulse when a new acceleration data is available
VDDIO	18	Supply	n/a	+1.8V to +5V	Reference voltage for the SPI signals and DRY, RSTB wires
RSTB	17	Digital	Input	VDDIO with 100kΩ pull-up	Reset. Reloads the internal calibration data.
ST	13	Digital	Output	+5V	Self-test status. Logic "1" when the sensor is OK
EN	4	Digital	Input	+5V with 100kΩ pull-up	Enable command. Active high
LVREF	2	Analog	n/a	4.4V	External decoupling pin. MUST be connected to the board's GND through a 100μF external capacitor, in order to ensure low noise
DNC	3, 10, 11, 12	--	--	--	Do Not electrically Connect. These pins provide additional mechanical fixing to the board and should be soldered to an unconnected pin

Table 3: Pin Functions

5. Soldering Recommendations

IMPORTANT NOTE: Manual soldering is prohibited as it would irreversibly degrade the sensor.

Please note that the reflow profile to be used does not depend only on the sensor. The whole populated board characteristics shall be considered.

MEMS components are sensitive to mechanical stress as a result of the soldering reflow. To ensure optimal performance, on-board recalibration of the sensor is recommended post-soldering. Please refer to section 7 for further details.

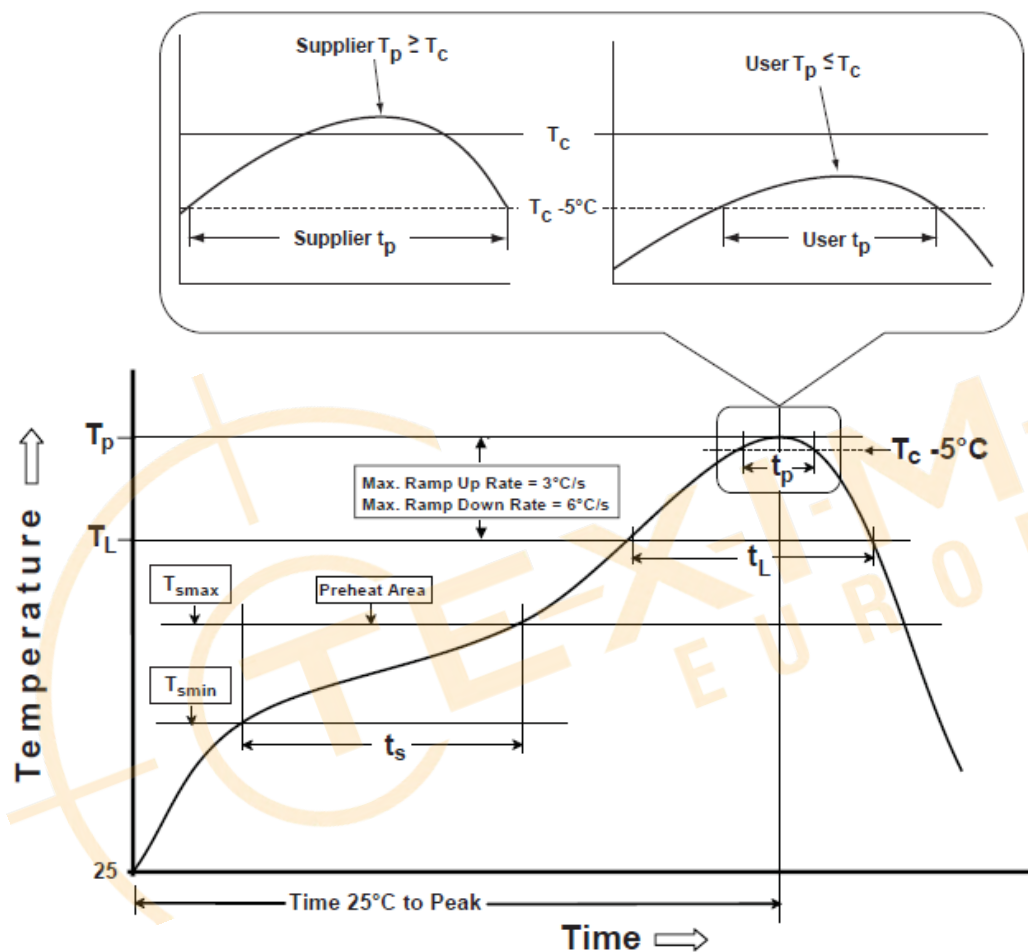

Figure 17: Recommended Reflow Profile, according to IPC/JEDEC J-STD-020D.1

Profile Feature	Pb-Free_Assembly
Time maintained above Temperature (T_L)	217°C
Time (t_L)	60-150 sec
Peak Temperature (T_p)	240°C (+/-5°C)
Time within 5°C of Actual Peak Temperature (t_p)	10-30 sec

Table 4: Recommended Reflow Profile Details, according to IPC/JEDEC J-STD-020D.1

6. Digital SPI Interface

6.1. Electrical and Timing Characteristics

The device acts as a slave supporting only SPI “mode 0” (clock polarity CPOL=0, clock phase CPHA=0).

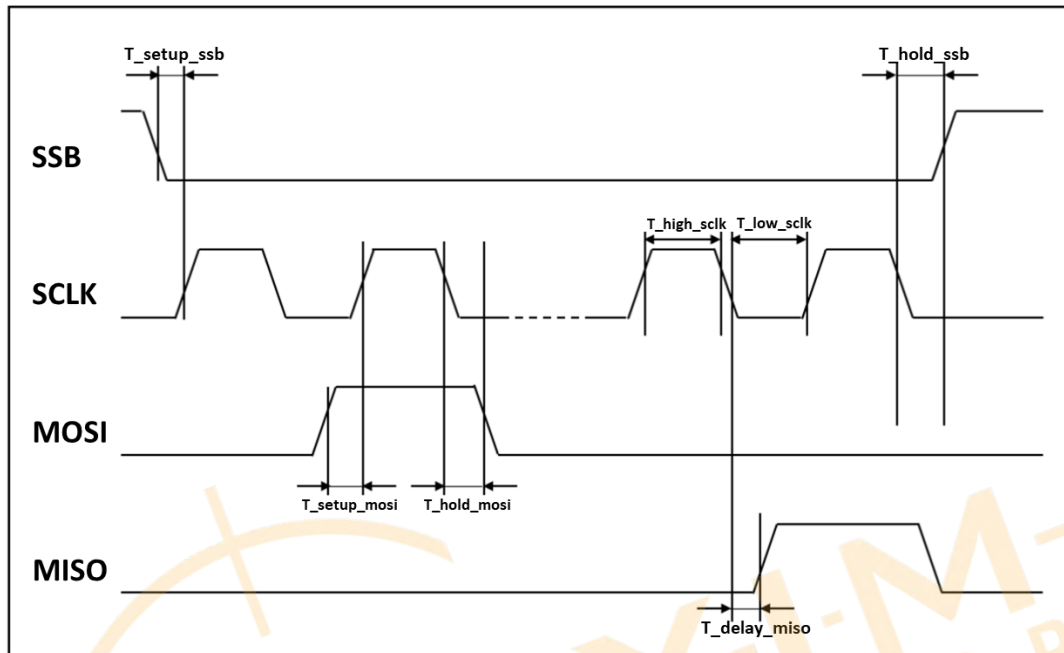

Figure 18: SPI timing diagram

Symbol	Parameter	Condition	Unit	Min	Typ	Max
Electrical characteristics						
VIL	Low level input voltage		VDDIO	0		0.1
VIH	High level input voltage		VDDIO	0.8		1
VOL	Low level output voltage	ioL=0mA (Capacitive Load)	V		GND	
VOH	High level output voltage	ioH=0mA (Capacitive Load)	V		VDDIO	
Rpull_up	Pull-up resistor	Internal pull-up resistance to VDD	kΩ		100	
Rpull_down	Pull-down resistor	Internal pull-down resistance to GND	kΩ		-	
Timing parameters						
Fspi	SPI clock input frequency	Maximal load 25pF on MOSI or MISO	MHz		0.2	8
T_low_sclk	SCLK low pulse		ns	62.5		
T_high_sclk	SCLK high pulse		ns	62.5		
T_setup_mosi	MOSI setup time		ns	10		
T_hold_mosi	MOSI hold time		ns	5		
T_delay_miso	MISO output delay	Load 25pF	ns			40
T_setup_ssb	SSB setup time		Tsclk	1		
T_hold_ssb	SSB hold time		Tsclk	1		

Table 5: SPI timing parameters

The MISO pin is kept in high impedance when the SSB level is high, which allows sharing the SPI bus with other components.

IMPORTANT NOTE: It is forbidden to keep SPI pins at a high level while VDD is at 0V due to ESD protection diodes and buffers.

6.2. SPI frames description

The SPI frames used for the communication through the SPI Register are composed of an instruction followed by arguments. The SPI instruction is composed of 1 byte, and the arguments are composed of 2, 4 or 8 bytes, depending on the cases, as can be seen in Table 6 below.



Figure 19: SPI Message Structure

Instruction	Argument	Meaning
0x50	0x00000000 (n=4)	Read Acceleration
0x54	0x0000 (n=2)	Read Temperature
0x50	0x000000000000 (n=6)	Read Acceleration and Temperature

Table 6: Authorized Basic SPI commands

6.3. Acceleration readings

From the 32-bits (4 bytes) frame obtained after the “Read acceleration” command, the 24-bits word of acceleration data (ACC) must be extracted as shown below in Figure 20.

DRY and ST are respectively the “data ready” and “self-test” bits, also directly available on Pins 19 and 13.

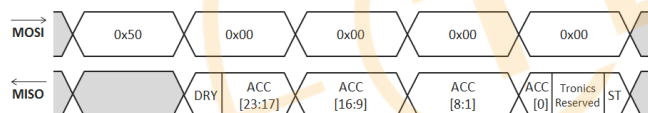

Figure 20: Acceleration reading frames and data organization

6.3.1. Acceleration (ACC) output

The 24-bit accelerometer output is coded in two's complement (Table 7).

- If the temperature compensation is not enabled (A_COMP_ON=0), then the user should perform scale factor measurements.
- If the temperature compensation of the acceleration output is enabled (default case), dividing the 24-bit value by a factor **1 000 000** results in the acceleration in g, as shown in Table 7.

-7.0000	g	↔	1001 0101 0011 0000 0100 0000
..			..
-1.0000	g	↔	1111 0000 1011 1101 1100 0000
..			..
-0.000001	g	↔	1111 1111 1111 1111 1111 1111
0.000000	g	↔	0000 0000 0000 0000 0000 0000
+0.000001	g	↔	0000 0000 0000 0000 0000 0001
..			..
+1.0000	g	↔	0000 1111 0100 0010 0100 0000
..			..
+7.0000	g	↔	0110 1010 1100 1111 1100 0000

Table 7: Conversion table for calibrated acceleration output

6.3.2. Data Ready (DRY) bit

The Data Ready bit is a flag which is raised when a new acceleration data is available. The flag stays raised until the data is read.

Similarly to the Data Ready pin, the Data Ready bit signal can be used as an interrupt signal to optimize the delays between newly available data and their readings.

6.3.3. Self-Test (ST) bit

AXO® sensor provides both an initial self-test, done during the sensor start-up to check the ASIC digital blocks integrity, and a continuous self-test in operation. The continuous self-test checks the integrity of the SPI communication as well as the closed-loop operation: the MEMS mobile mass is at its equilibrium position and the force feedback is operating nominally.

The self-test procedure is running in parallel with the main functions of the sensor. The self-test status is available at the same time as the sensor output.

The ST bit contains the same information as the ST pin. It is updated at the sensor data rate. The ST pin can be connected to an interrupt input.

6.4. Temperature readings

The temperature data is an unsigned integer, 14-bits word (TEMP). It must be extracted from the 2 bytes of read data, as shown below in Figure 21.

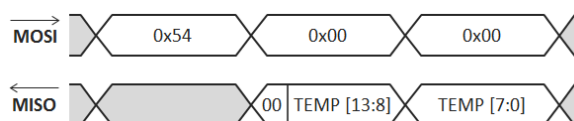

Figure 21: Temperature reading frames and data organization

By default the temperature sensor is *not* factory-calibrated (TOUT_SEL=0).

6.5. Advanced use of SPI registers

SPI registers can also be used to access the System register or the MTP (Multi-Time-Programmable memory) by writing the corresponding SPI command. The following subsections describe the detailed processes to access them by read and write command.

6.5.1. R/W access to the System Registers

IMPORTANT NOTE: Modifications to the system registers are **reversible**. Modified registers will *not* be restored after a RESET. There is no limitation to the number of times the system registers can be modified.

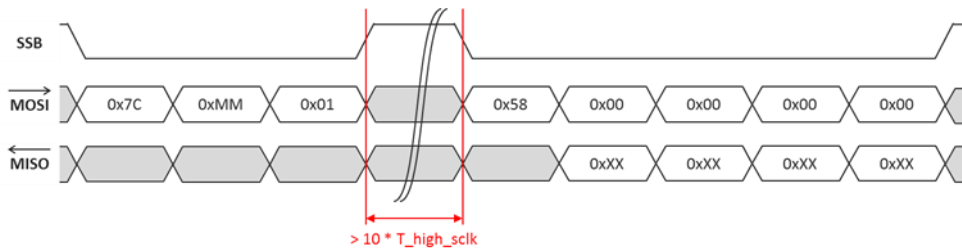

Figure 22: Sequence of instructions to READ address 0xMM of the system registers

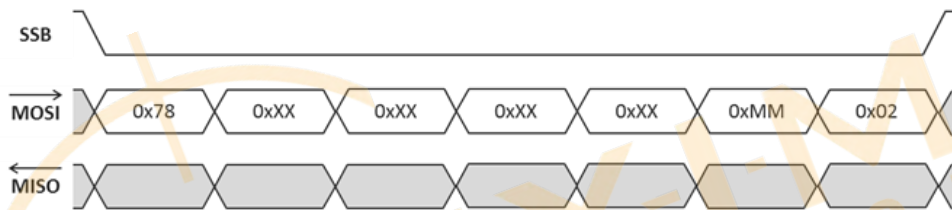

Figure 23: Sequence of instructions to WRITE '0XXXXXXXX' to address '0xMM' of the system registers

6.5.2. R/W access to the MTP

IMPORTANT NOTE: Modifications to the MTP are **non-reversible**. Modified parameters will be restored, even after a RESET, and previous values of the MTP cannot be accessed anymore. The maximum number of times the MTP can be written depends on the address:

- 5 times for the acceleration calibration coefficients (see Section 7 for more details)
- Only 1 time for all the other coefficients, including the temperature sensor calibration coefficients.

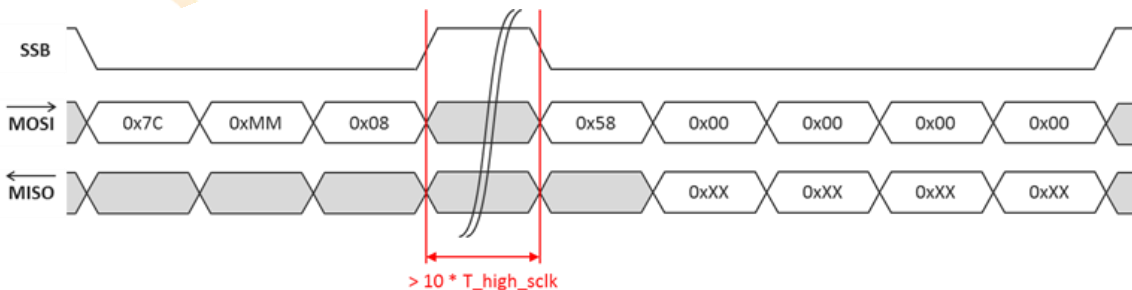

Figure 24: Sequence of instructions to READ address 0xMM of the MTP

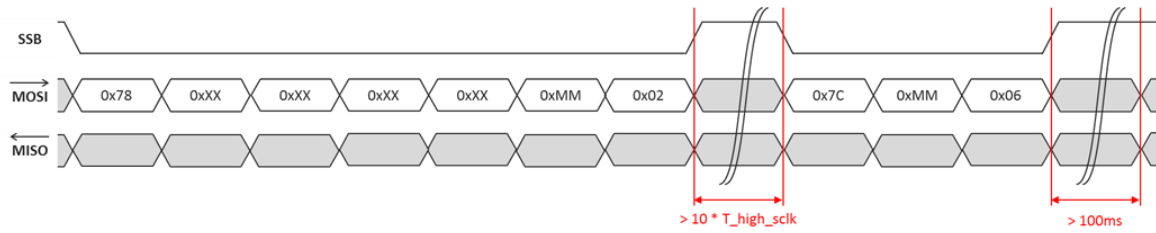

Figure 25: Sequence of instructions to WRITE data '0xXXXXXXXX' to address '0xMM' of the MTP

6.5.3. Useful Sensor Parameters

The instructions given in Sections 6.5.1 and 6.5.2 can be used to read and/or to modify the sensor's useful parameters given in Table 8 below.

Parameter	Address MM ⁽¹⁾ (System Register & MTP)	Bits	Encoding	Meaning
Sensor Identification				
UID	0x03	[31:0]	Tronics reserved	Sensor 'Unique Identification' number
Modification of data rate				
ODRSEL	0x3D	[7:2]	Binary 0b001111**	From minimum value of 0 [0b000000] to maximum value of 49 [0b110001] - See section 6.6
Temperature output compensation				
TOUT_SEL	0x04	3 ⁽²⁾	0 ⁽³⁾ 1	Disable the calibrated temperature output Enable the calibrated temperature output
O	0x04	[31:18] ⁽²⁾	0x0000 ⁽³⁾ See section 8	Offset calibration of temperature sensor
G	0x04	[17:4] ⁽²⁾	0x0800 ⁽³⁾ See section 8	Gain calibration of temperature sensor
Acceleration output compensation				
GOUT_SEL	0x3D	31 ⁽²⁾	0 1 ⁽³⁾	Disable the calibrated acceleration output Enable the calibrated acceleration output
MTPSLOTNB	0x3D	[12:8] ⁽²⁾	0b00000 0b00001 ⁽³⁾ 0b00011 0b00111 0b01111 0b11111	Unprogrammed part Programmed once, 4 slots remaining Programmed twice, 3 slots remaining Programmed 3 times, 2 slots remaining Programmed 4 times, 1 slot remaining Programmed 5 times, no slot remaining
SF4	0x48	[18:0] ⁽²⁾	See Table 9	Scale Factor 4th order coefficient (calibrated acceleration)
SF3	0x46	[19:0] ⁽²⁾	See Table 9	Scale Factor 3rd order coefficient (calibrated acceleration)
SF2	0x44	[20:0] ⁽²⁾	See Table 9 Table 9	Scale Factor 2nd order coefficient (calibrated acceleration)
SF1	0x42	[29:0] ⁽²⁾	See Table 9	Scale Factor 1st order coefficient (calibrated acceleration)
SF0	0x3F	[30:0] ⁽²⁾	See Table 9	Scale Factor constant coefficient (calibrated acceleration)
B4	0x47	[18:0] ⁽²⁾	See Table 9	Bias 4th order coefficient (calibrated acceleration)
B3	0x45	[19:0] ⁽²⁾	See Table 9	Bias 3rd order coefficient (calibrated acceleration)
B2	0x43	[19:0] ⁽²⁾	See Table 9	Bias 2nd order coefficient (calibrated acceleration)
B1	0x41	[29:0] ⁽²⁾	See Table 9	Bias 1st order coefficient (calibrated acceleration)
B0	0x3E	[23:0] ⁽²⁾	See Table 9	Bias constant coefficient (calibrated acceleration)
TMID	0x40	[19:0] ⁽²⁾	See Table 9	Mid-temperature calibration point

Table 8: Useful parameters information

⁽¹⁾ Only addresses on Table 8 can be modified without damaging the behavior of the sensor.

⁽²⁾ The other bits at those addresses shall remain unchanged. Please make sure that you write them without modification!

⁽³⁾ Default Value

6.6. Modification of the data rate

AXO305 can be used in a wide variety of inertial systems (IMU, INS, AHRS, stabilization platform...) having different data processing capabilities depending on the target application. In order to make sure the output data from the sensors is properly processed at system-level (eg: avoid data overflow on the microcontroller data bus), Tronics provides the capability to increase or decrease the output data rate of AXO305 product.

The formula below gives the data rate:

$$Data\ rate[Hz] = \frac{15\ 000}{ODRSEL + 1}$$

The default decimal value for ODRSEL is 5 [0b000101] but it can be tuned from 0 (corresponding to a data rate of 15 kHz) to 49 (data rate of 300 Hz). To tune this parameter, please refer to section 6.5.3.

In order to avoid data aliasing and to ensure a reliable vibration rectification error (VRE), we recommend keeping the data rate above 600 Hz, corresponding to ODRSEL =24.

IMPORTANT NOTE: As the default ODRSEL value is already programmed in the OTP and cannot be rewritten, the custom value needs to be loaded in the System Register each time the sensor is powered on.



7. Acceleration calibration procedure

7.1. Algorithm overview

After the filtering stage, the raw acceleration sensor output is temperature compensated based on the on-chip temperature sensor output and the stored temperature compensation parameters.

7.1.1. Acceleration calibration model

The formula below models the link between raw and compensated acceleration outputs:

$$ACC[g] = \frac{ACC_{COMP}[LSB]}{SF_{setting}[LSB/g]} = \frac{ACC_{RAW}[LSB] - BIAS[LSB]}{SF[LSB/g]}$$

where:

- ACC is the acceleration output converted in g;
- ACC_{COMP} is the calibrated acceleration output;
- SF_{setting} is the constant conversion factor from LSB to g for the calibrated acceleration output. Default value for this parameter is SF_{setting} = 1 000 000;
- ACC_{RAW} is the raw data acceleration output;
- **BIAS** is a polynomial (4th degree) temperature-varying coefficient to model the sensor's bias temperature variations;
- **SF** is a polynomial (4th degree) temperature-varying coefficient to model the sensor's Scale Factor temperature variations.

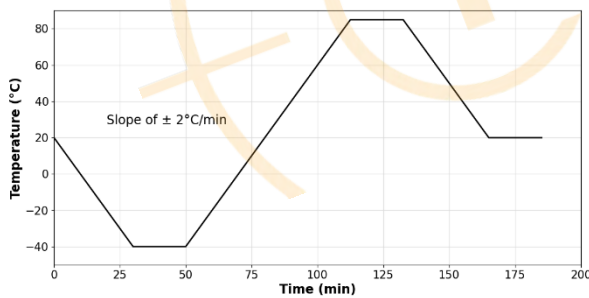

Figure 26: Recommended Temperature profile for calibration

¹ Temperature profile can be adapted to be in line with customer applications.

² Rate applied can be adapted to be in line with customer applications.

7.1.2. Recommended procedure

1. Set GOUT_SEL to 0 in the System Registers (disable the calibration)
2. Place the sensor on a rate table in a thermal chamber and implement temperature profile according to Figure 26¹
3. Perform continuous acquisition of the acceleration output with the following pattern:
 - Rest position (0g input) to evaluate the BIAS parameter
 - + 1g input then -1g input to evaluate the SF parameter²
4. Calculate the coefficients of BIAS and SF polynomials (for example using mean square method):

$$BIAS = \sum_{i=0}^4 b_i (T_{RAW} - T_{MID})^i$$

$$SF = \sum_{i=0}^4 sf_i (T_{RAW} - T_{MID})^i$$

where

- T_{RAW} is the raw output of the temperature sensor **multiplied by 64**;
 - T_{MID} is the mid-value of T_{RAW};
 - b₀ to b₄ are the 5 coefficients of BIAS polynomial;
 - sf₀ to sf₄ are the 5 coefficients of SF polynomial.
5. Convert T_{MID}, b_i and sf_i parameters to their binary values according to Table 9 below:

Parameter	Value (decimal)	Format
SF4	sf ₄ · 2 ⁹² / SF _{setting}	signed 2's comp
SF3	sf ₃ · 2 ⁷² / SF _{setting}	signed 2's comp
SF2	sf ₂ · 2 ⁵⁵ / SF _{setting}	signed 2's comp
SF1	sf ₁ · 2 ⁴⁶ / SF _{setting}	signed 2's comp
SF0	sf ₀ · 2 ²⁷ / SF _{setting}	signed 2's comp
B4	b ₄ · 2 ⁷³	signed 2's comp
B3	b ₃ · 2 ⁵³	signed 2's comp
B2	b ₂ · 2 ³²	signed 2's comp
B1	b ₁ · 2 ²⁰	signed 2's comp
B0	b ₀	signed 2's comp
TMID	T _{MID}	unsigned

Table 9: Acceleration calibration parameters

7.2. Programming of the new coefficients

IMPORTANT NOTE: The following steps are **non-reversible**. The previous values of the coefficients will not be accessible anymore. The temperature compensation coefficients can be re-programmed up to 4 additional times on the IC.

The programming procedure consists in three major steps:

- Checking the available MTP slot status
- Programming the coefficients
- Updating the available MTP slot status

An overview of the procedure is given in Figure 27.

7.2.1. Checking the MTP slot status

The first step is to check the number of remaining MTP slots (MTPSLOTNB), in other words, checking how many times the chip has been programmed before.

The detailed information of MTPSLOTNB register content is given in Table 8. The sequence of instructions to read the register is given in section 6.5.

The MTP slot number (MTPSLOTNB) re-programming iteration is given in the following Table 10:

Iteration	Correspondence	MTP number	
		Value	Binary
0	Unprogrammed part	0	00000
1	Programmed once	1*	00001
2	Programmed twice	3	00011
3	...	7	00111
4		15	01111
5	Cannot be further programmed	31	11111

Table 10: MTPSLOTNB iterations

* Default value

7.2.2. Programming the coefficients

This step describes the procedure for programming the calculated coefficients (temperature compensation of acceleration output). The programming procedure is:

1. Write SF4 in the system register
2. Program SF4 in the MTP
3. Write SF3 in the system register
4. Program SF3 in the MTP
5. Write SF2 in the system register
6. Program SF2 in the MTP
7. Write SF1 in the system register
8. Program SF1 in the MTP
9. Write SF0 in the system register
10. Program SF0 in the MTP
11. Write B4 in the system register
12. Program B4 in the MTP

13. Write B3 in the system register
14. Program B3 in the MTP
15. Write B2 in the system register
16. Program B2 in the MTP
17. Write B1 in the system register
18. Program B1 in the MTP
19. Write B0 in the system register
20. Program B0 in the MTP
21. Write TMID in the system register
22. Program TMID

The detailed SPI commands are given in section 6.5. The detailed information about each coefficient is given in Table 8.

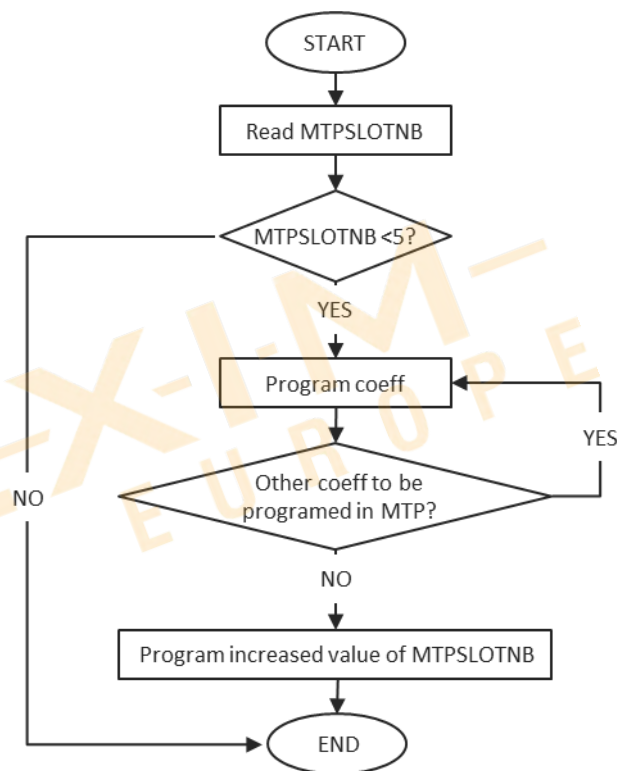

Figure 27: Procedure to program new calibration parameters

7.2.3. Updating MTP slot status

This section describes the procedure for programming the updated status of the MTP slots.

If this step is not performed properly, the new compensation coefficients will not be effective.

1. Read the MTPSLOTNB as described in section 6.5.2
2. Increment MTPSLOTNB according Table 9.
3. Write the updated MTPSLOTNB in the system register.
4. Program the updated MTPSLOTNB in the MTP.
5. After a reset, the new coefficients will be available.

7.3. Switch to uncompensated data output

To optimize the thermal compensation of the acceleration output, it is possible to disable the on-chip compensation and use the uncompensated (raw) output to perform an external thermal compensation.

IMPORTANT NOTE: This step is **non-reversible**. The previous values of the coefficients will not be accessible anymore.

To switch the acceleration output to uncompensated data, the procedure is exactly the same as described in section 7.2, but the coefficients given in Table 9 must be replaced by the coefficients given below in Table 11.

Parameter	Value (hexadecimal)
SF4	0x0
SF3	0x0
SF2	0x0
SF1	0x0
SF0	0x0800 0000
B4	0x0
B3	0x0
B2	0x0
B1	0x0
B0	0x0
TMID	0x0

Table 11: Acceleration compensation coefficients to obtain raw data

8. Temperature Sensor Calibration Procedure

The temperature output of AXO305 sensors is not factory-calibrated, since only the relative temperature output is needed to perform temperature compensation of the acceleration output. However, it is possible to perform a first-order polynomial calibration of the temperature sensor, in order to output the absolute temperature information.

This section shows how to get and store temperature calibration parameters for the temperature output.

8.1. Temperature sensor calibration model

The formula below models the link between raw and calibrated temperature output:

$$T[^\circ\text{C}] = \frac{T_{\text{COMP_OUT}}[\text{LSB}]}{\text{GAIN}_{\text{setting}}[\text{LSB}/^\circ\text{C}]} = \frac{\text{GAIN} \cdot T_{\text{RAW}}[\text{LSB}] - \text{OFFSET}[\text{LSB}]}{\text{GAIN}_{\text{setting}}[\text{LSB}/^\circ\text{C}]}$$

where:

- **T** is the output temperature converted in °C;
- **T_{COMP_OUT}** is the calibrated temperature output;
- **GAIN_{setting}** is the constant conversion factor from LSB to °C for the calibrated temperature output. This gain is set to 85LSB/°C;
- **T_{RAW}** is the raw data temperature output;
- **OFFSET** is a constant coefficient to tune the offset;
- **GAIN** is a constant coefficient to tune gain.

The **OFFSET** and **GAIN** parameters will be computed and written in the ASIC as per the following calibration procedure.

8.2. Recommended Procedure

1. Check that TOUT_SEL = 0. If not, set it to 0 in the System Registers.
2. Measure the temperature output with at least 2 temperature points T₁ and T₂.

3. Calculate the GAIN and OFFSET coefficients according to formula above

$$\text{GAIN} = \text{GAIN}_{\text{setting}} \cdot \frac{T1_{\text{ABS}}[^\circ\text{C}] - T2_{\text{ABS}}[^\circ\text{C}]}{T1_{\text{RAW}}[\text{LSB}] - T2_{\text{RAW}}[\text{LSB}]}$$

$$\text{OFFSET} = \text{GAIN}_{\text{setting}} \cdot T1_{\text{ABS}}[^\circ\text{C}] - \text{GAIN} \cdot T1_{\text{RAW}}[\text{LSB}]$$

where:

- T_{1ABS} is the absolute temperature of T₁ in °C;
 - T_{2ABS} is the absolute temperature of T₂ in °C;
 - T_{1RAW} is the raw output temperature of T₁ in LSB;
 - T_{2RAW} is the raw output temperature of T₂ in LSB;
4. Convert GAIN and OFFSET to their binary values according to Table 12 below:

Parameter	Value (decimal)	Format
G	GAIN · 2 ¹¹	Unsigned
O	OFFSET	Unsigned

Table 12: Temperature calibration parameters

5. [Optional step: Write GAIN and OFFSET into the System Registers and repeat step 2. to check the accuracy of the new calibration.]
6. Write GAIN and OFFSET into the MTP according to instructions of Section 6.5.2. Meanwhile, set TOUT_SEL to 1 during this step, so that the new calibration parameters are effective after a RESET.

9. Device Identification / Ordering information

9.1. Device identification

AXO305 tracking information is accessible on the label, as shown in the Figure 28.

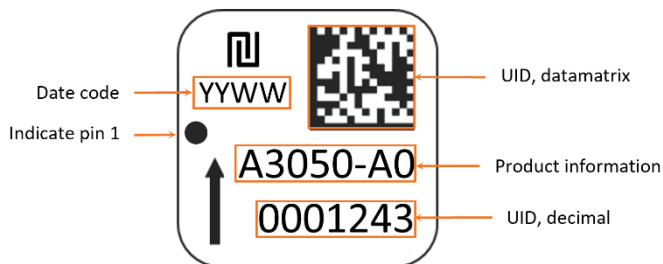

Figure 28: AXO305 label

9.2. Ordering information

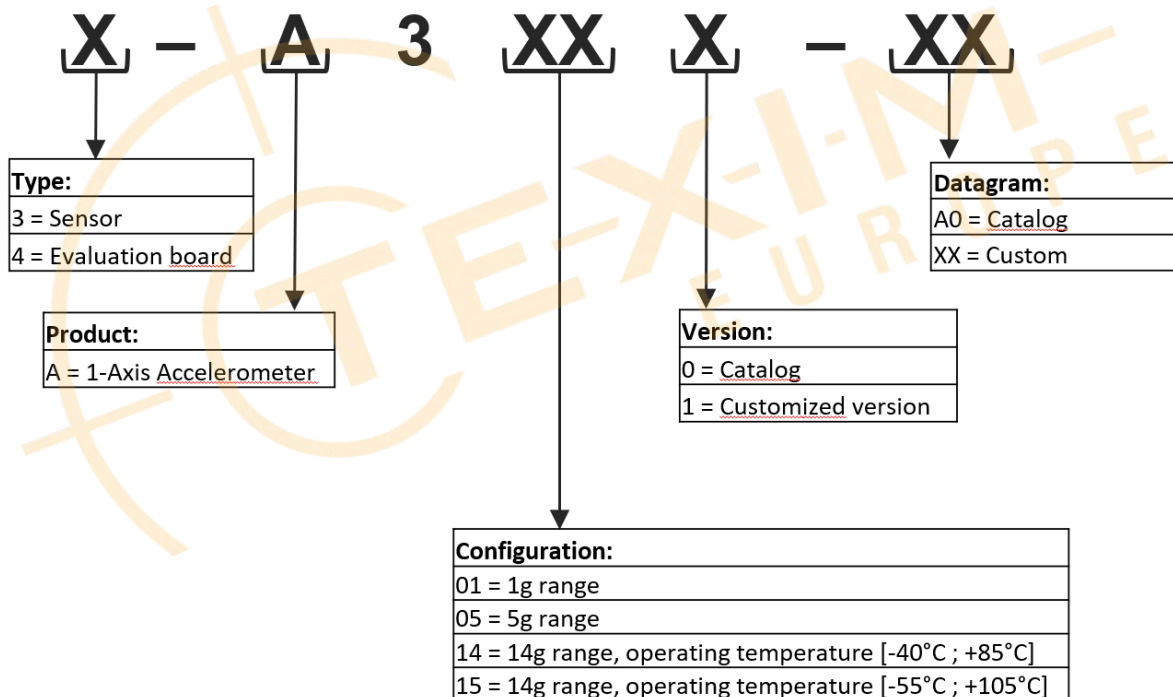

Figure 29: Ordering information

Product	Ordering code
AXO305	3-A3050-A0
AXO305-EVB3	4-A3050-A0

Table 13: Product ordering code

10. Internal construction and Theory of Operation

AXO305 sensor is using the dominant architecture for high performance MEMS accelerometers, namely the “In-plane Force-rebalance” design. A symmetric silicon proof mass is suspended by pairs of opposing spring flexures on either side of the proof mass. An applied acceleration acts on the proof mass. This in-plane motion is counterbalanced by applying voltages that generate electrostatic forces to rebalance the proof mass (closed-loop operation). The applied voltage is directly proportional to the input acceleration.

In details, each sensor consists in a MEMS transducer and an integrated circuit (IC) packaged in a 28-pins J-leaded Ceramic Package.

The MEMS transducer is manufactured using Tronics' hermetic wafer-level packaging technology where the microstructure is micro-machined thick single crystal silicon for its mechanical reliability.

The MEMS die is located on the left part of the block diagram. Differential detection and actuation are used for efficient common mode rejection. The sensor is factory calibrated and compensated for temperature effects to provide high-accuracy digital output over a broad temperature range.

Raw data output can be also chosen to enable customer-made compensations.

The IC is located on the right part of the block diagram. The IC is designed to interface the MEMS sensing element. It is fully hard-coded and includes no firmware or software. Its 24-bit digital SPI output suppresses the need for costly high resolution A/D converter at the systems level.

It includes ultra-low noise capacitive to voltage converters (C2V) followed by high resolution voltage digitization (ADC). Excitation voltage required for capacitance sensing circuits is generated on the common electrode node. 1-bit force feedbacks (DAC) are used for electrostatic actuation.

The digital part implements digital control loop and processes the acceleration output based on the on-chip temperature sensor output. The system controller manages the interface between the SPI registers, the system register and the non-volatile memory (OTP). The non-volatile memory provides the accelerometer settings, in particular the coefficients for acceleration temperature compensation. On power up, the settings are transferred from the OTP to the system registers and output data are available in the SPI registers. The acceleration output and the temperature sensor output are available in the SPI registers. The SPI registers are available through the SPI interface (SSB, SCK, MOSI, MISO). The self-test and the data ready are available respectively on the external pin ST and DRY.

The “References” block generates the required biasing currents and voltages for all blocks as well as the low-noise reference voltage for critical blocks.

The “Power Management” block manages the power supply of the sensor from a single 5V supply between the VDD and GND pins. It includes a power on reset as well as an external reset pin (RSTB) to start or restart operation using default configuration. An enable pin (EN) with power-down capability is also available.

The sensor is powered with a single 5V DC power supply through pins VDD and GND. Although the sensor contains three separate VDD pins, the sensor is supplied by a single 5V voltage source. It is recommended to supply the three VDD pins in a star connection with appropriate decoupling capacitors. Regarding the sensor grounds, all the GND pins are internally shorted. The GND pins redundancy is used for multiple bonds in order to reduce the total ground inductance. It is therefore recommended to connect all the GND pins to the ground.

11. Available Tools and Resources

The following tools and resources are available on our [website](#) or upon request.









Description	
Item	
Documentation & technical notes	
	AXO305 - Datasheet
Mechanical tool	
	AXO305 - 3D model
Evaluation kit	
	Tronics EVB3 – Evaluation board <i>Evaluation board for AXO305, compatible with Arduino Leonardo</i>
	Tronics Evaluation Tool – Software
	Tronics EVB3 – User manual
	Tronics Evaluation Kit – Quick Start Guide
	Tronics Evaluation Tool – Software User Manual
	Tronics Evaluation Tool – Arduino Firmware

Table 14: Available tools and resources

12. Revision History

Item	Datasheet Version
MCD035-F	
Application circuit	Update schematic on Figure 15
Soldering recommendation	Update recommendation on section 5
Soldering reflow profile	Update Tab 4 T _L value
SPI command	Update Tab 6
MCD035-E	
ODRSEL register address	Correction of ODRSEL parameter register address
MCD035-D	
Product life cycle update	Product maturity from Serial Samples to Production
Bias Instability (Allan Variance)	Nominal value changed
Bias long term stability	Nominal value changed
1 year composite scale factor repeatability	Nominal value changed
Residual scale factor temperature error	Nominal value changed
Scale factor long term stability	Nominal value changed
Noise density	Nominal value changed
Velocity Random Walk (VRW)	Nominal value changed
MCD035-C	
SPI timing diagram	Correction of SPI timing diagram (SPI mode 0)

Disclaimer

ALL PRODUCTS, PRODUCT SPECIFICATIONS AND DATA ARE SUBJECT TO CHANGE WITHOUT NOTICE TO IMPROVE RELIABILITY, FUNCTION OR DESIGN OR OTHERWISE.

Texim Europe B.V. its affiliates, agents, and employees, and all persons acting on its or their behalf (collectively, "Texim"), disclaim any and all liability for any errors, inaccuracies or incompleteness contained in any datasheet or in any other disclosure relating to any product.

Texim makes no warranty, representation or guarantee regarding the suitability of the products for any particular purpose or the continuing production of any product.

It is the customer's responsibility to validate that a particular product with the properties described in the product specification is suitable for use in a particular application.

Parameters provided in datasheets and / or specifications may vary in different applications and performance may vary over time.

All operating parameters, including typical parameters, must be validated for each customer application by the customer's technical experts.

Please contact us if you have any questions about the contents of the datasheet.

This may not be the latest version of the datasheet. Please check with us if a later version is available.

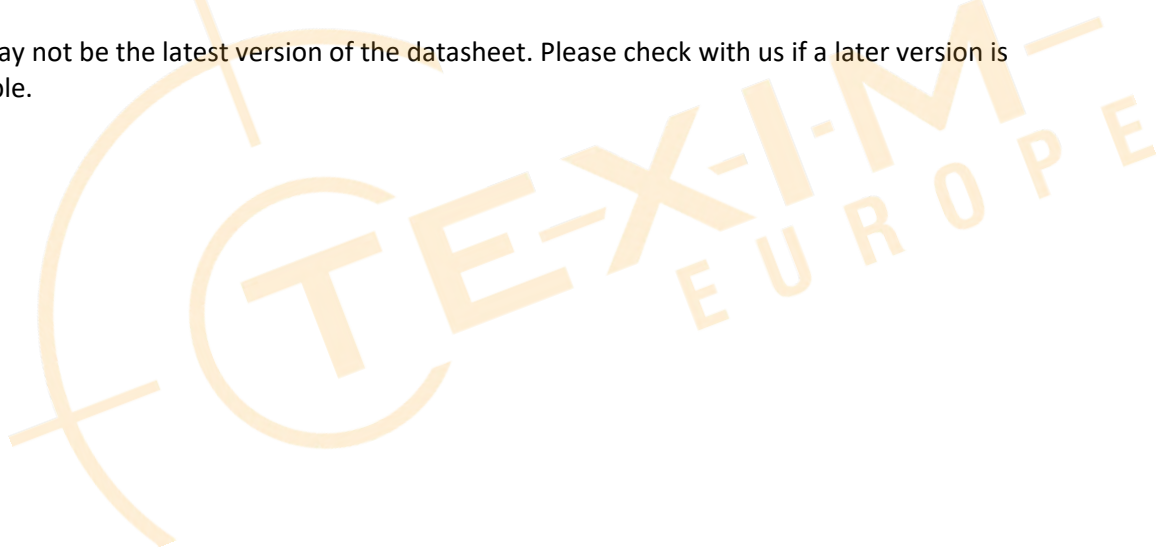



Headquarters & Warehouse

Elektrostraat 17
 NL-7483 PG Haaksbergen
 The Netherlands

T: +31 (0)53 573 33 33
 E: info@texim-europe.com
 Homepage: www.texim-europe.com



The Netherlands

Elektrostraat 17
 NL-7483 PG Haaksbergen

T: +31 (0)53 573 33 33
 E: nl@texim-europe.com



Belgium

Zuiderlaan 14, box 10
 B-1731 Zellik

T: +32 (0)2 462 01 00
 E: belgium@texim-europe.com



UK & Ireland

St Mary's House, Church Lane
 Carlton Le Moorland
 Lincoln LN5 9HS

T: +44 (0)1522 789 555
 E: uk@texim-europe.com



Germany

Bahnhofstrasse 92
 D-25451 Quickborn

T: +49 (0)4106 627 07-0
 E: germany@texim-europe.com



Germany

Martin-Kollar-Strasse 9
 D-81829 München

T: +49 (0)89 436 086-0
 E: muenchen@texim-europe.com



Austria

Warwitzstrasse 9
 A-5020 Salzburg

T: +43 (0)662 216 026
 E: austria@texim-europe.com



Nordic

Stockholmsgade 45
 2100 Copenhagen

T: +45 88 20 26 30
 E: nordic@texim-europe.com



Italy

Martin-Kollar-Strasse 9
 D-81829 München

T: +49 (0)89 436 086-0
 E: italy@texim-europe.com