

Distributed by:



www.texim-europe.com

PenMount Touchscreen 6000 Control Board Installation Guide

Revision 1.7
2/November/12



Preface

Disclaimer

The information in this document is subject to change without notice. The manufacturer makes no representations or warranties regarding the contents of this manual and specifically disclaims any implied warranties of merchantability or fitness for any particular purpose. Furthermore, the manufacturer reserves the right to revise this publication or make changes in the specifications of the product described within it at any time without notice and without obligation to notify any person of such revision.

Trademarks

PenMount, Microsoft, Windows and other trademarks and product names used in this manual are the properties of their respective owners and are acknowledged.

Copyright

This publication, including all photographs, illustrations and software, is protected under international copyright laws, with all rights reserved. Neither this manual, nor any of the material contained herein, may be reproduced without the express written consent of the manufacturer.

©Copyright 2010

Revision Table

Date	Revision	Changes
29/Dec/'08	1.0	Initial
21/Jul/'09	1.1	<u>Chapter 5. PenMount Gesture AP</u> is added.
04/Sep/'09	1.2	Sections updated are: <ul style="list-style-type: none"> ● <u>3.2.1. Install PenMount Windows Universal Driver (for 2000/XP/2003/VISTA/7)</u> ● <u>3.2.2. > 3.2.2.1. > Setting: Pen Input Emulation & Click on Release</u> are added to <u>Operation Mode</u>.
06/Oct/'09	1.3	● Refinement of Installation Diagrams in section <u>2.2</u> .
21/Oct/'09	1.4	<ul style="list-style-type: none"> ● <u>Chapter 2 > 2.3 > 2.3.1. Install PenMount 6200D Control Board:</u> The picture of PenMount 6200x Control Board Upside is updated. ● <u>Chapter 2 > 2.3 > 2.3.2. Install A PenMount 6202B Control Board:</u> The picture of PenMount 6202x Control Boards Upside are updated. ● PenMount 6202 is changed to “6202x” in this manual. ● To each PenMount 6200x, 6202x, 6300 and 6500 Control Boards, mechanical diagrams are added. See sections <u>2.3.1</u>, <u>2.3.2</u>, <u>2.3.3</u>, and <u>2.3.4</u>.
09/Dec/'09	1.5	● <u>Chapter 2 > 2.2 Installation Diagrams:</u> The installation diagrams are revised for 6200x, 6202x, 6300, and 6500 boards.
01/Mar/'10	1.6	<ul style="list-style-type: none"> ● PM6202X is changed to PM6202B on page <u>1</u> and <u>3</u>. ● PM6200X is changed to PM6200A on page <u>4</u> and to PM6200C on page <u>錯誤! 尚未定義書籤。</u> ● PM6200X is changed to PM6200A or PM6200C and the pictures and mechanical diagrams are updated for PM6200A and 6200C on page <u>9</u>, <u>錯誤! 尚未定義書籤。</u>, and <u>10</u>. ● PM6202X is changed to PM6202B and graphics are rearranged on page <u>11</u>, <u>11</u>, and <u>12</u>. ● PM6300 graphics are changed on page <u>26</u>. ● PM6500 graphics are changed on page <u>錯誤! 尚未定義書籤。</u> ● PM6202X is changed to PM6202B on page <u>15</u>. ● Refinement of section <u>3.2 Install PenMount Windows Universal Driver (for 2000/XP/XPT/XPE/2003/VISTA/7/WES7/2008/8)</u> starting from page <u>21</u>. ● Graphic of <u>Windows XP 64bit tools</u> is changed on page <u>28</u>. ● The original <u>3.2.5. PenMount Rotating Function</u> is advanced <u>3.2.3.3 PenMount Rotating Function</u> on page <u>28</u>. And “Vista 32/64bit” is deleted from the description. ● PM6202X is changed to PM6202B on page <u>錯誤! 尚未定義書籤。</u> ● <u>PenMount Linux X Window RS-232 and USB Drivers support table</u> is updated on page <u>33</u>. ● To the software function table in <u>Chapter 4 Driver Software Functions</u> on page <u>35</u>, VISTA/7 column and an additional remark are added. In the same table, Stream/Point Mode is changed to Operation Mode. ● The screenshots of <u>PenMount Control Panel</u> are updated on page <u>35</u>.

		<ul style="list-style-type: none"> ● <u>Gesture Enable</u> is added to PenMount Control Panel functions on page <u>36</u>. ● 4 points calibration is deleted from Advanced Calibration on page <u>36</u>. ● “Vista 32/64bit” and “Windows 7 32/64bit” are deleted from the description of <u>4.3 Multiple Monitors</u> on page <u>36</u>. ● All screenshots in section <u>4.3 Multiple Monitors</u> are updated starting from page <u>36</u>. ● Screenshot of PenMount Control Panel’s Tools tab is updated on page <u>42</u>. ● Section 4.7 is replaced by <u>Mouse Operation Mode</u> on page <u>44</u>. ● The screenshots of AP are updated on page <u>45</u>. ● The screenshots of <u>PenMount Control Panel</u> and <u>Gestture Setting</u> are updated on page <u>48</u>. ● The screenshots of PenMount Gestures under Windows XP/Vista/7 are updated on page <u>49</u>. ● Screenshots of <u>Gesture Setting</u> and the description of <u>General Setting Box</u> are updated on page <u>50</u>. ● Icons of PenMount gestures are updated on page <u>51</u>.
10/Sep/’12	1.7	<ul style="list-style-type: none"> ● PM6200A and PM6200C are changed into PM6200D. PM6300 is changed to PM6300A. PM6500 is changed to PM6500A. The correspondent pictures and mechanical diagrams are updated on chapter <u>2.2</u> and <u>2.3</u>. ● The updated drivers on chapter <u>1.3</u> and <u>3.3</u> support Windows 8, WinCE 7.0 and new Linux system. ● The updated installation guide of PenMount Windows universal driver is on chapter <u>3.2</u>.

Table of Contents

Preface	ii
Disclaimer	ii
Trademarks	ii
Copyright	ii
Revision Table	iii
Chapter 1. Introduction	1
1.1. About this Manual.....	1
1.2. PenMount 6000 Control Boards.....	1
1.3. Drivers & Utilities	2
1.4. After Sales Service	2
Chapter 2. Install PenMount 6000 Control Boards	3
2.1. Installation Requirements.....	3
2.1.1. Computer	3
2.1.2. Touchscreen.....	3
2.1.3. Control Board.....	3
2.2. Installation Diagrams.....	4
2.2.1. The connection of 6200D Control Board (for both RS-232 & USB Interfaces).....	4
2.2.2. The connection of 6202B Control Board (for both RS-232 & USB Interfaces).....	5
2.2.3. The connection of 6300A Control Board (for USB Interface Only)	7
2.2.4. The connection of 6500A Control Board (for both RS-232 & USB Interfaces).....	8
2.3. RS-232 & USB Boards (6000 Series)	9
2.3.1. Install PenMount 6200D Control Board	9
2.3.2. Install A PenMount 6202B Control Board	11
2.3.3. Install A PenMount 6300A Control Board.....	13
2.3.4. Install A PenMount 6500A Control Board.....	14
Chapter 3. Install Drivers for 6000 Boards	15
3.1. Install PenMount DOS Driver	15
3.1.1. Install PenMount DOS Driver.....	15
3.1.2. PenMount DOS Driver Functions.....	16
3.2. Install PenMount Windows Universal Driver	21
3.2.1. Install PenMount Mouse Driver in Win 2000/XP/XPT/XPE/2003/VISTA/7/WES7/2008/8	22
3.2.2. Install PenMount Digitizer Driver in Win XPT/VISTA/7/ WES7/2008/8	23
3.2.3. Configure Touchscreen In PenMount mouse driver.....	23
3.2.3.1 PenMount Control Panel.....	24
3.2.3.2 PenMount Monitor Menu Icon.....	28
3.2.3.3 PenMount Rotating Function	28
3.2.4. The Touchscreen Configure of PenMount Digitizer Driver.....	29
3.2.5. Uninstall PenMount Windows Universal Driver	33
3.3. Install PenMount Linux X Window RS-232/USB Driver	33
3.3.1. Install PenMount Linux X Window RS-232 Driver and USB Driver	34
3.3.2. Calibration Utilities	34
3.4. Install PenMount WinCE Driver.....	34
3.4.1. Install PenMount WinCE Driver	34
Chapter 4. Driver Software Functions	35
4.1. Standard Calibration.....	36
4.2. Advanced Calibration	36
4.3. Multiple Monitors	36
4.3.1. Requirements.....	37
4.3.2. An Example for 2 Units of Touch Monitor.....	38
4.4. Multiple Devices	40
4.4.1. Compare Functions.....	41
4.4.2. Requirements.....	41
4.5. Rotation	42

Table of Contents

4.6.	Draw	42
4.7.	Mouse Operation Mode.....	44
4.8.	Beep Sound.....	44
4.9.	Beep Sound Adjustable	44
4.10.	Wake Up Function.....	44
4.11.	Plot Calibration Data	44
4.12.	Right Button.....	45
4.13.	Hide Cursor	45
4.14.	Cursor Offset.....	45
4.15.	Double Click Area and Speed	45
4.16.	About.....	45
4.17.	Edge Compensation.....	46
4.18.	Refresh.....	46
Chapter 5.	PenMount Gesture AP for Windows 2000/XP/VISTA/7	47
5.1.	Invoke PenMount Gesture AP	47
5.2.	Configure PenMount Gesture AP	48
5.3.	PenMount Gestures' Default Values in Windows XP	51

Chapter 1. Introduction

PenMount Touchscreen Control Board is the most popular touchscreen control board on the market. PenMount control boards, chipsets, and software support a wide range of configurations, applications, and operating systems. Designed for easy configuration and superior touchscreen performance, the PenMount 6000 control boards are offered for both RS-232 and USB interfaces except 6300, which only supports USB interface.

PenMount Touchscreen Control Board is a circuit board that you install between a touchscreen and a host computer. The control board converts touch input into digital data, which is then converted by software into data that emulates the input from a computer's mouse device.

The control boards are comprised of an interface board for mounting on a host computer, a controller chip, other supporting components, and software drivers. The bundled software drivers offer unique functions and support the most popular hardware platforms and operating systems.

PenMount control boards are designed not only to be user-friendly, but also to support engineers. All PenMount control boards provide a diagnostic LED that allows both users and engineers to check the touchscreen and the control board functions.

1.1. About this Manual

This manual describes the features of the PenMount Touchscreen Control Board series, how to connect a control board, and how to install and use the software drivers and utilities with your operating system.

This manual is for users who are using the PenMount Touchscreen Control Board and software, as well as for engineers who are integrating and customizing the control board for use with other products.

1.2. PenMount 6000 Control Boards

PenMount 6000 control boards are configured for the use with both RS-232 and USB interfaces (except 6300 only supporting USB interface). Depending on design or product requirements, PenMount also provides controller ICs. A 6000 control board connects to a touchscreen, a power supply (when using RS-232 interface) and a computer system's RS-232 or USB port. PenMount 6000 offers four control boards:

Model	Interface	Touchscreen Wire Support
PenMount 6200D	RS-232 & USB	4, 5, 8
PenMount 6202B	RS-232 & USB	4, 5
PenMount 6300A	USB	4, 5, 8
PenMount 6500A	RS-232 & USB	4, 5, 8

1.3. Drivers & Utilities

All of the 6000 control boards come bundled with software drivers and utilities that support the most popular hardware platforms and operating systems. Once you install the drivers and utilities, you can use this software to configure and calibrate your touchscreen. Drivers for PenMount 6000 boards support the following operating systems:

O.S. that PenMount 6000 Boards Drivers Supports

O.S.	PenMount	6200D		6202B		6300A	6500A	
		USB	RS-232	USB	RS-232	USB	USB	RS-232
DOS			•		•			•
2000/XP/2003/VISTA/7/8		•	•	•	•	•	•	•
Linux (Kernel 2.6 & X-Windows Mode)		•	•	•	•	•	•	•
WinCE 4.2/5.0/6.0/7.0		•	•	•	•	•	•	•

1.4. After Sales Service

PenMount 6000 control boards and software are modified and updated on a regular basis. For more latest updated information, downloads, and technical support, please refer to our website at: <http://www.penmount.com/>

Chapter 2. Install PenMount 6000 Control Boards

The procedures that follow describe how to install and configure the hardware for each of the PenMount 6000 Control Boards.

2.1. Installation Requirements

You need the following to install a touchscreen using a PenMount 6000 Touchscreen Control Board:

2.1.1. Computer

1. An IBM-compatible host computer
2. A communications port, either RS-232 or USB (For 6300, only USB)
3. A Compact Disc drive
4. Operating systems required: See table "**O.S. that PenMount 6000 Boards Drivers Supports**" on page 2 for details.

2.1.2. Touchscreen

1. A 4-wire tail analog resistive touchscreen (for all 6000 boards)
2. A 5-wire tail analog resistive touchscreen (for all 6000 boards)
3. A 8-wire tail analog resistive touchscreen (for all 6000 boards except 6202B)

2.1.3. Control Board

1. A PenMount 6000 Touchscreen Control Board
2. Cables to connect the control board to the touchscreen and the computer's communications port.
3. The PenMount Drivers & Utilities disk.
4. A cable to connect the power supply. (This is only required when connecting with RS-232 port).

2.2. Installation Diagrams

2.2.1. The connection of 6200D Control Board (for both RS-232 & USB Interfaces)

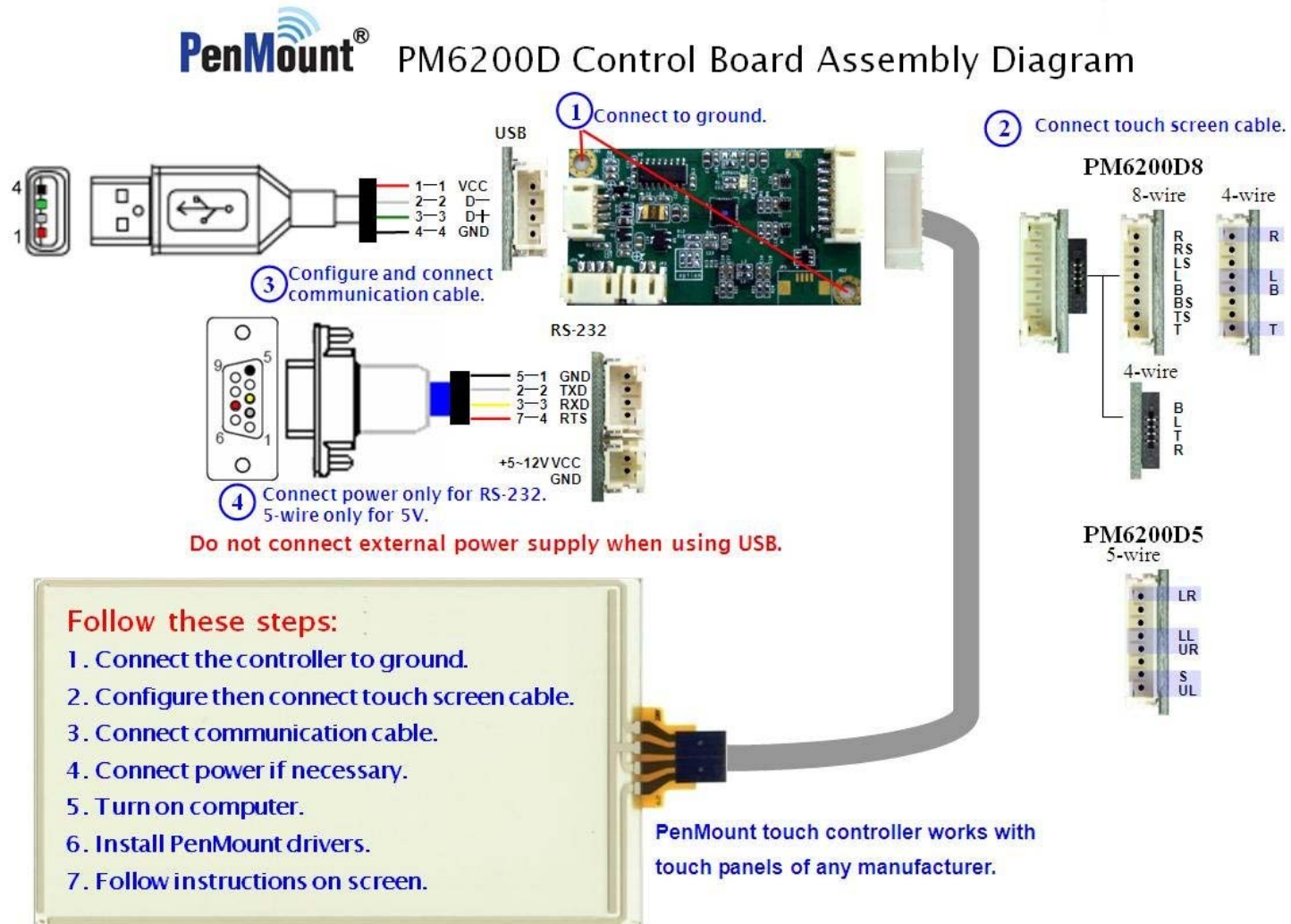

2.2.2. The connection of 6202B Control Board (for both RS-232 & USB Interfaces)

PenMount® PM6202B Control Board Assembly Diagram

P.1

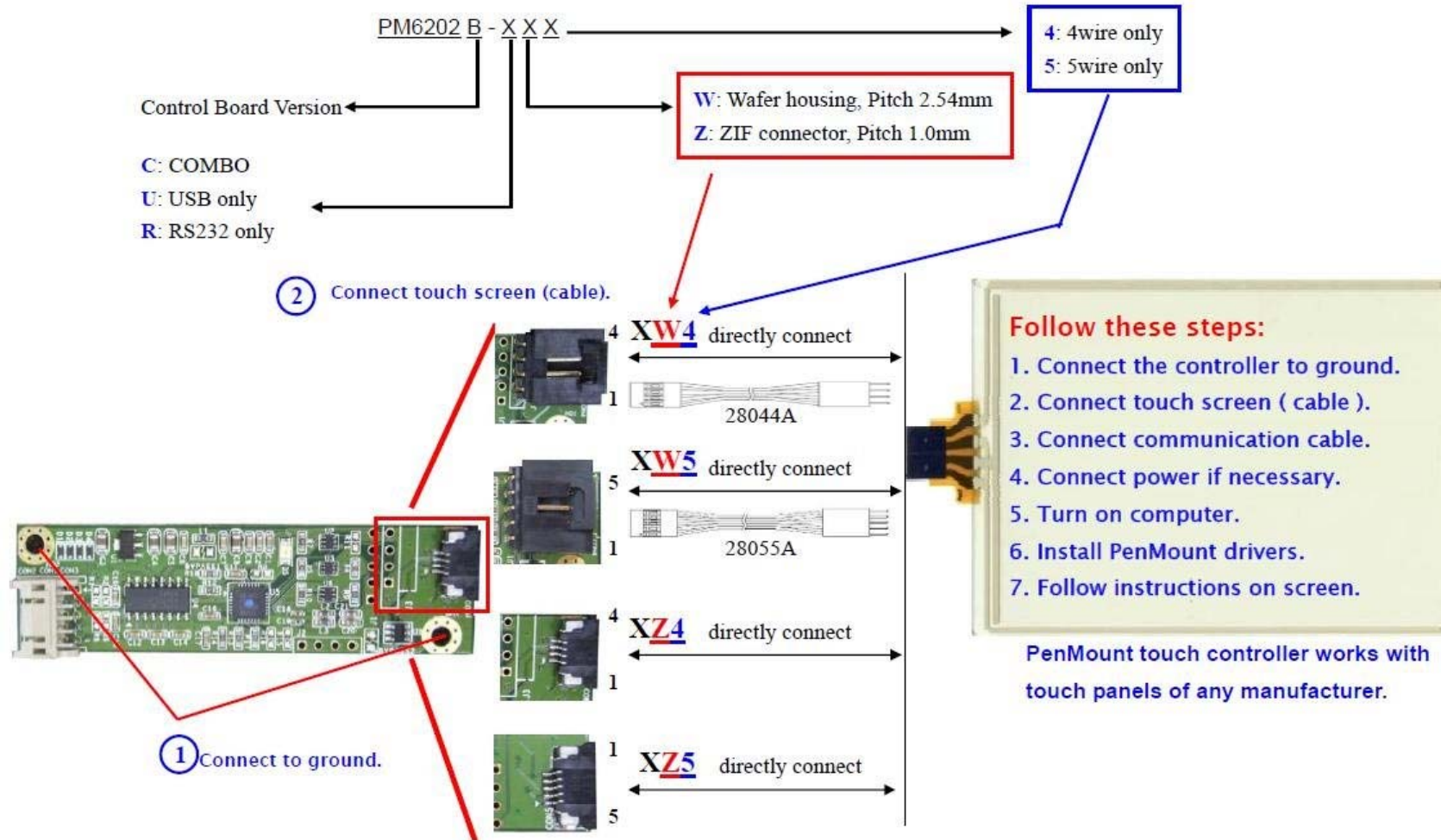

PenMount[®] PM6202B Control Board Assembly Diagram

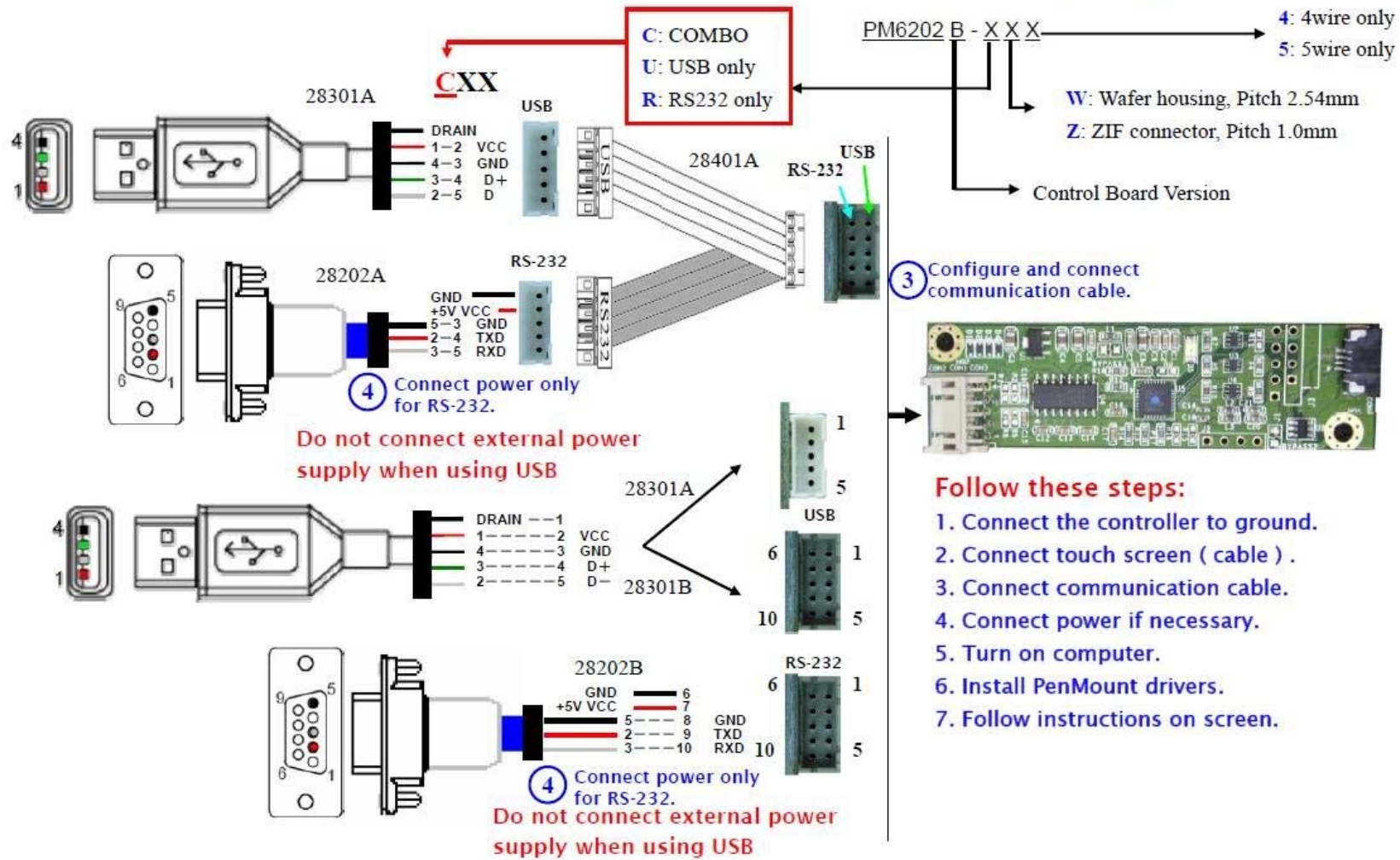

2.2.3. The connection of 6300A Control Board (for USB Interface Only)

PenMount[®] PM6300A Control Board Assembly Diagram

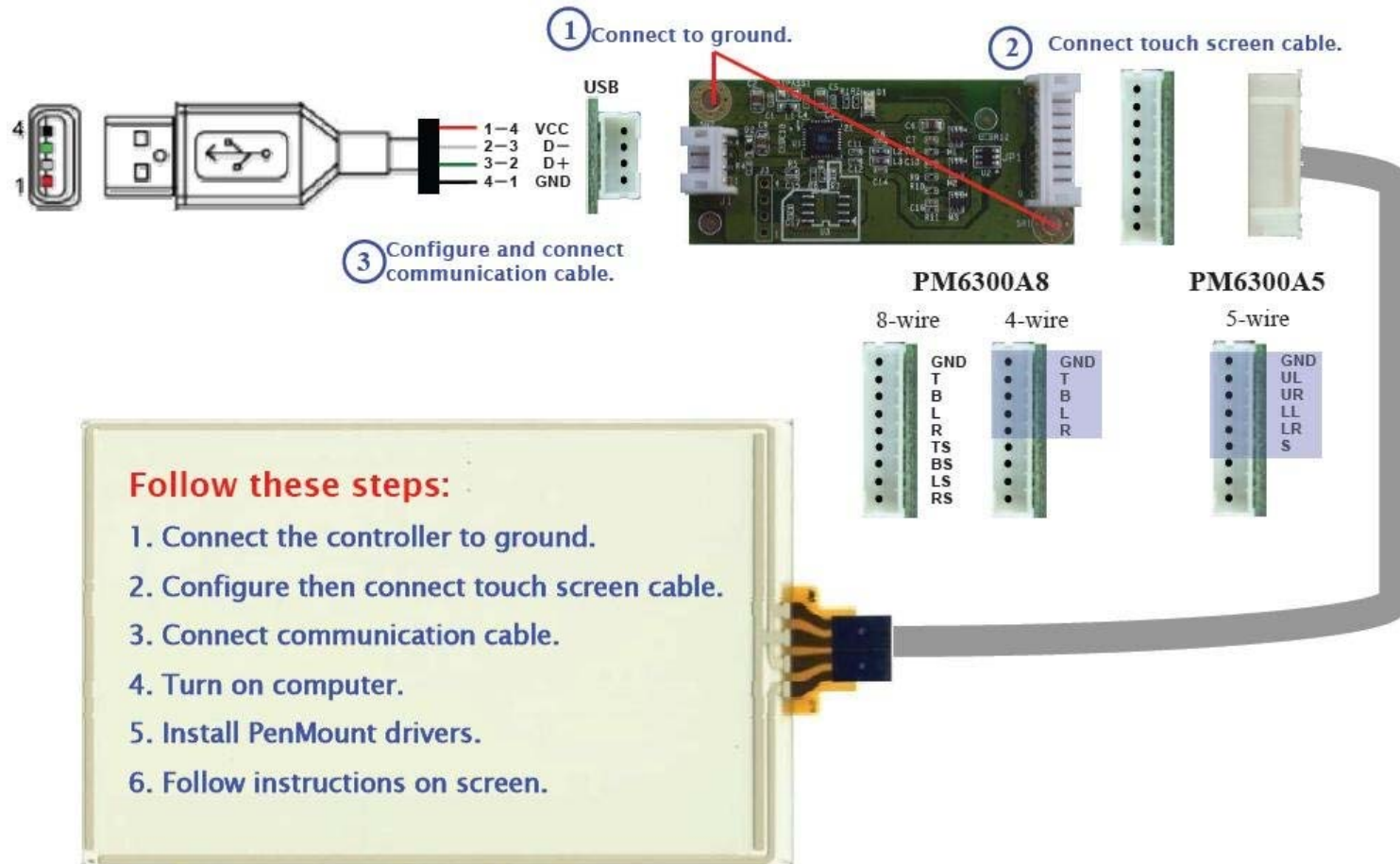

Follow these steps:

1. Connect the controller to ground.
2. Configure then connect touch screen cable.
3. Connect communication cable.
4. Turn on computer.
5. Install PenMount drivers.
6. Follow instructions on screen.

PenMount touch controller works with touch panels of any manufacturer.

Chapter 2 Installing PenMount 6000 Control Boards

2.2.4. The connection of 6500A Control Board (for both RS-232 & USB Interfaces)

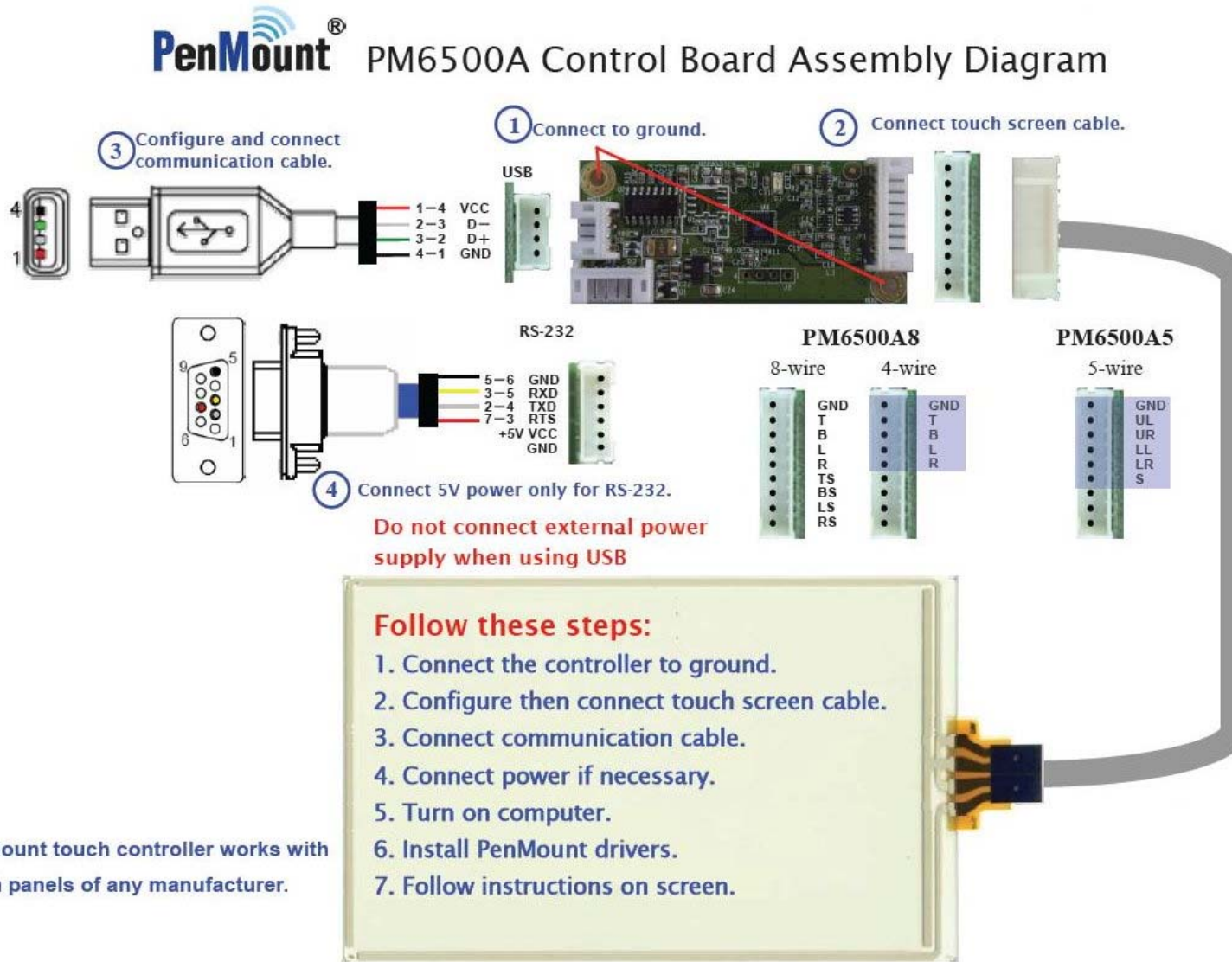

2.3. RS-232 & USB Boards (6000 Series)

All PenMount 6000 control boards use both RS-232 serial interface and USB interface except 6300 which only supports USB connection. There are currently four models in the 6000 Series. The general procedure for board installation is similar, though hardware connection and configuration varies for each board.

2.3.1. Install PenMount 6200D Control Board

PenMount 6200D control boards are touchscreen control boards that use both RS-232 and USB interfaces and supports 4-wire, 5-wire, and 8-wire touchscreens. The size of the board is 62.0 x 33.0 mm and it has five connectors and four dipswitches on-board. Follow the steps below to install the 6200D control board.

1. Cut off the power of your computer and display, then open the case of the display or the system. Find space on your system and attach the control board to your system with screws. The control board has industry standard 3φ screw holes.
2. For the other installation details, see 2.2.1 on page 4: **The connection of 6200D Control Board (for both RS-232 & USB Interfaces)**.

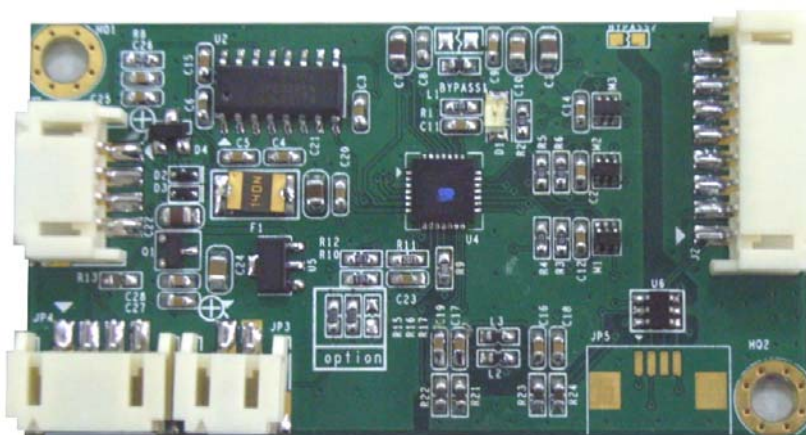

PenMount 6200D Touchscreen Control Board Upside

3. Turn on the computer and the display. Install the software drivers and utilities and calibrate the touchscreen. See **Chapter 3. Install Drivers for 6000 Boards** for details.

Chapter 2 Installing PenMount 6000 Control Boards

4. The mechanical diagrams of PenMount 6200D Control Boards:

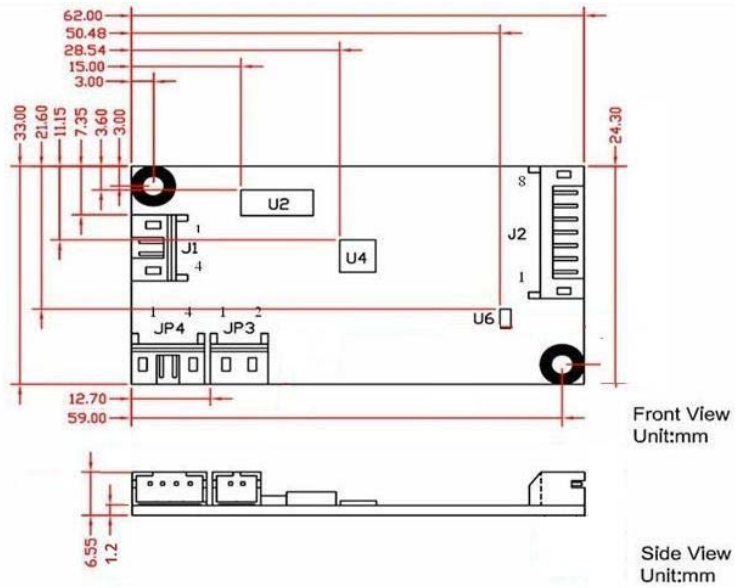

PenMount 6200D5 Touchscreen Control Board Mechanical Diagram

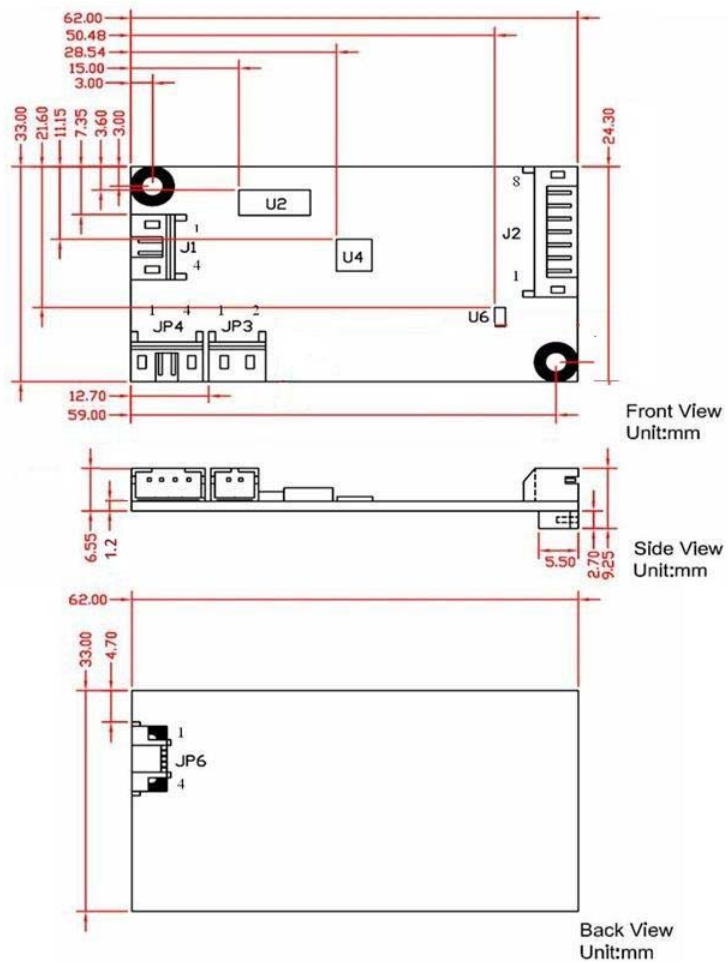

PenMount 6200D8 Touchscreen Control Board Mechanical Diagram

Installing PenMount 6000 Control Boards

2.3.2. Install A PenMount 6202B Control Board

PenMount 6202B control boards are touchscreen control boards that use both RS-232 and USB interfaces and supports 4-wire and 5-wire touchscreens. The size of the board is 70.0 x 20.0 mm and it was designed-in with two kinds of connector. One is connected with touchscreen directly for 4-wire or 5-wire selective while the other is supported by both of RS-232 and USB interfaces.

Follow the steps below to install PM6202B control boards.

1. Cut off the power of your computer and display, then open the case of the display or the system. Find space on your system and attach the control board to your system with screws. The control board has industry standard 3φ screw holes.
2. For other installation details, see 2.2.2 on page 5: The connection of 6202B Control Board (for both RS-232 & USB Interfaces).

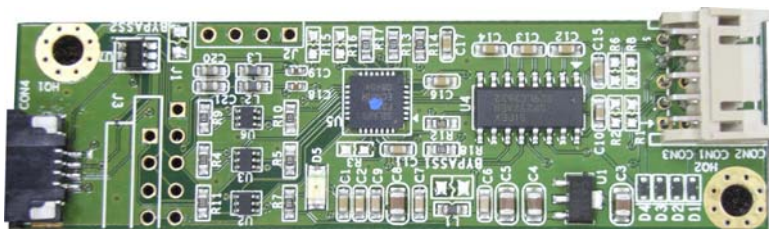

PenMount 6202B CZ4 Touchscreen Control Boards Upside

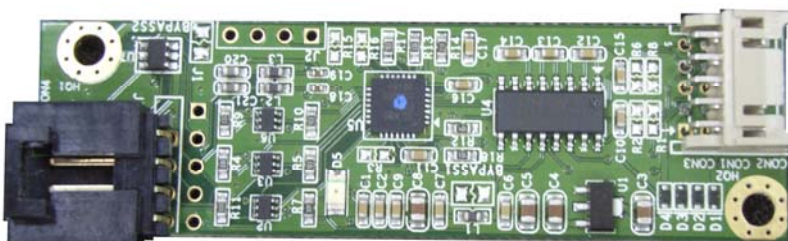

PenMount 6202B CW4 Touchscreen Control Boards Upside

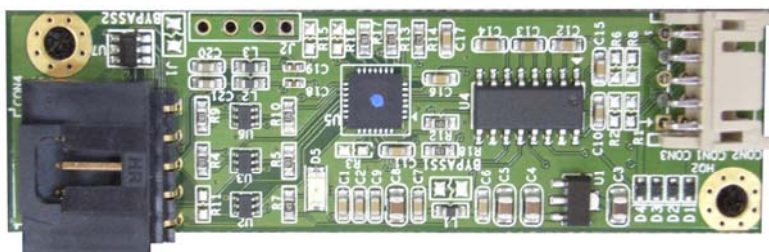

PenMount 6202B CW5 Touchscreen Control Boards Upside

3. Power on the computer and the display. Install the software drivers and utilities and calibrate the touchscreen. See **Chapter 3. Install Drivers for 6000 Boards** for details.

Chapter 2 Installing PenMount 6000 Control Boards

4. The mechanical diagrams of PenMount 6202B Control Boards

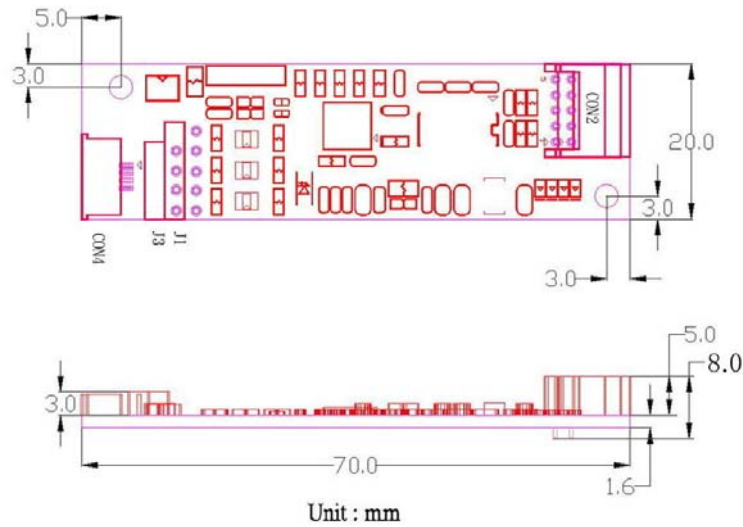

PenMount 6202B CZ4 Control Board Mechanical Diagram

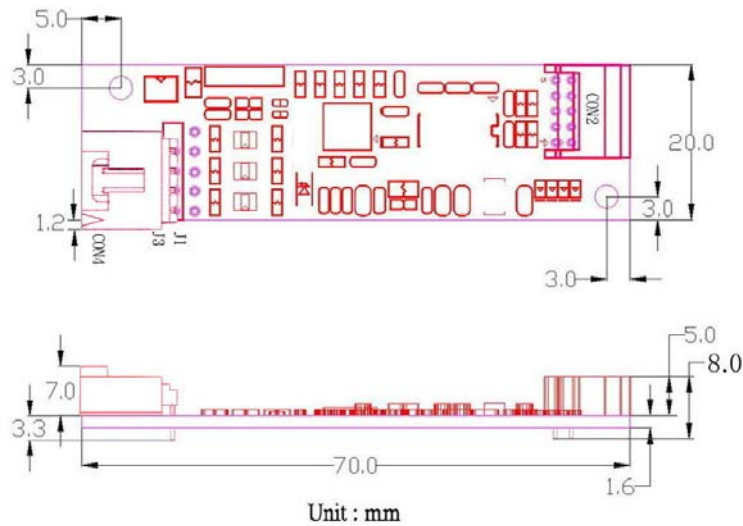

PenMount 6202B CW4 Control Board Mechanical Diagram

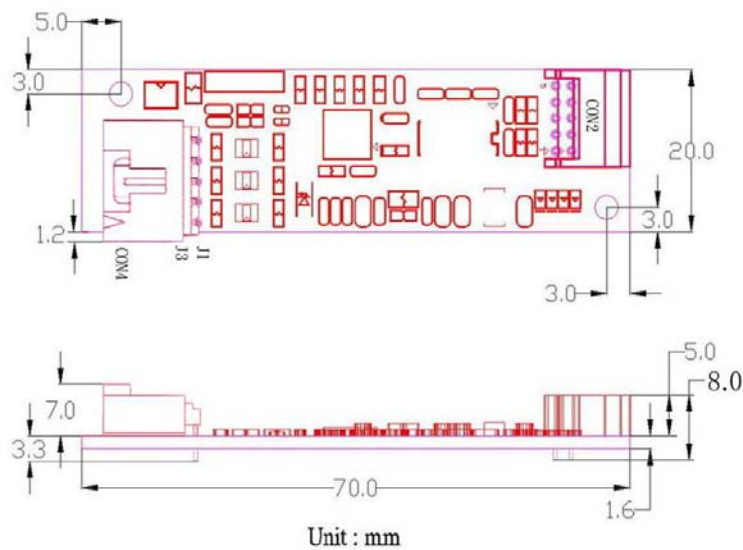

PenMount 6202B CW5 Control Board Mechanical Diagram

Installing PenMount 6000 Control Boards

2.3.3. Install A PenMount 6300A Control Board

The PenMount 6300A control board is a touchscreen control board that uses USB interface only. It supports 4-wire, 5-wire and 8-wire touchscreens. The size of the board is 26 x 60mm and it has two connectors and two dipswitches on-board. Follow the steps below to install the 6300A control board.

1. Cut off the power of your computer and display, then open the case of the display or the system. Find space on your system and attach the control board to your system with screws. The control board has industry standard 3φ screw holes.
2. For other installation details, see 2.2.3 on page 7: The connection of 6300A Control Board (for USB Interface Only).

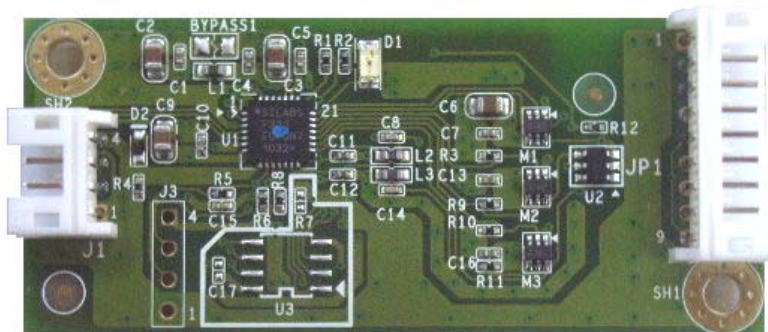

PenMount 6300A Touchscreen Control Board Upside

3. Power on the computer and the display. Install the software drivers and utilities and calibrate the touchscreen. See **Chapter 3. Install Drivers for 6000 Boards** for details.
4. The mechanical diagram of PenMount 6300A Control Board:

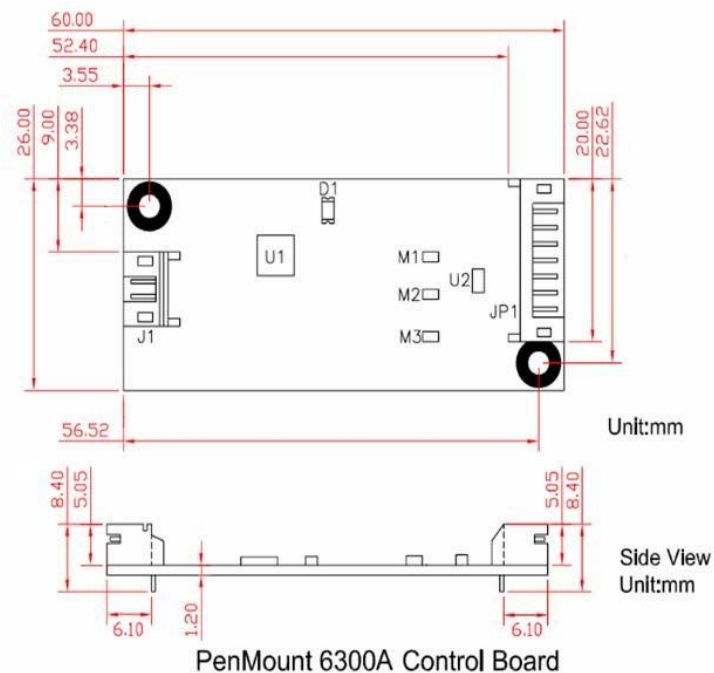

PenMount 6300A Touchscreen Control Board Mechanical Diagram

2.3.4. Install A PenMount 6500A Control Board

The PenMount 6500A control board is a touchscreen control board that uses both RS-232 and USB interfaces and supports 4-wire, 5-wire, and 8-wire touchscreens. The size of the board is 26 x 60 mm and it has two connectors and four dipswitches on-board. Follow the steps below to install the 6500A control board.

1. Cut off the power of your computer and display, then open the case of the display or the system. Find space on your system and attach the control board to your system with screws. The control board has industry standard 3φ screw holes.
2. For other installation details, see 2.2.4 on page 8: The connection of 6500A Control Board (for both RS-232 & USB Interfaces).

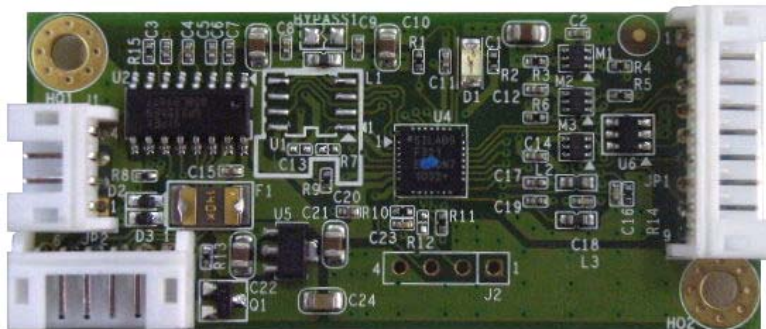

PenMount 6500A Touchscreen Control Board Upside

3. Power on the computer and the display. Install the software drivers and utilities and calibrate the touchscreen. See **Chapter 3. Install Drivers for 6000 Boards** for details.
4. The mechanical diagram of PenMount 6500A Control Board:

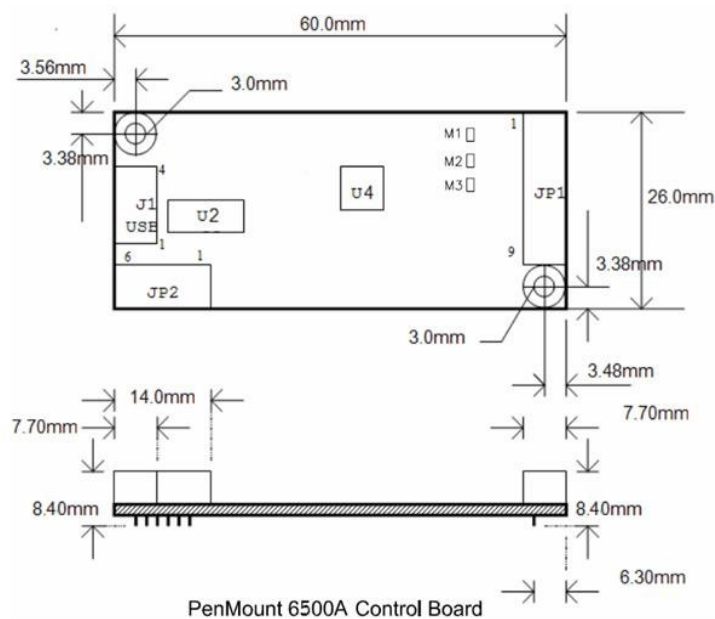

PenMount 6500A Control Board Mechanical Diagram

Chapter 3. Install Drivers for 6000 Boards

This chapter describes how to install drivers and other software that enables your PenMount 6000 control boards to work with various operating systems.

PenMount 6000 boards support the following connections:

Interface \ PenMount	6200D	6202B	6300A	6500A
RS-232	▪	▪		▪
USB	▪	▪	▪	▪

RS-232 driver and USB driver for PenMount 6000 boards support the following operating systems:

Driver \ O.S.	DOS	2000/XP/2003/ VISTA/7/8	Linux (Kernel 2.6 & X-Windows Mode)	Win CE (4.2/5.0/6.0/7.0)
RS-232 Driver	▪	▪	▪	▪
USB Driver		▪	▪	▪

3.1. Install PenMount DOS Driver

Before installing DOS driver, you must have DOS system installed and running on your computer. You must also have PenMount Serial Interface either 6200x, 6202x or 6500 control boards installed.

3.1.1. Install PenMount DOS Driver

PenMount DOS Driver version 2.10 diskette contains the following files:

- INSTALL.EXE** -- PenMount installation program
- PM2.EXE** -- PenMount Utility, to configure or test the PenMount touchscreen
- PMOUSE.EXE** -- Driver loader, to load or unload driver.
- PMTSR.COM** -- PenMount DOS Driver
- PMOUSE.CFG** -- The configuration file for PenMount DOS driver
- README.TXT** -- The file you're reading now.
- PMINIT.BAT** -- Reload DOS driver batch file
- PMUNLOAD.BAT** -- Unload DOS driver batch file
- PMTEST.EXE** -- PenMount driver test utility to verify PenMount driver working.
- MOUSETST.COM** -- Mouse Test utility

If you have an older version of **PenMount DOS Driver** installed in your system, remove it first. PenMount 6000 control board has an optional cable for 9-pin D-sub connector. And whenever RS-232 port is used, be sure to plug the control board into the COM port of PC (e.g. COM1, COM2, COM3 or COM4) before installing driver.

Installing Drivers for 6000 Boards

Follow the steps below to install **PenMount DOS Driver**.

Step 1: Decompress the driver package. (e.g. C:\TEMP)

Step 2: Go to the working directory. (e.g. cd \TEMP)

Step 3: Run the installation program "install.exe" at DOS prompt.

Step 4: The install.exe will lead you to complete the installation.

Step 5: Restart computer (Recommended)

or

press 'ESC' key and issue 'SET
PENMOUNT=<penmount_installation_path>' at DOS prompt.

Step 6: Driver will be loaded after restarting computer.

Note:

1. Environment Variable – PENMOUNT

The environment variable, PENMOUNT, is needed for PenMount driver v2.10.

The installation program will put the command line 'SET
PENMOUNT=<penmount_install_path>' into the AUTOEXEC.BAT, like:

```
SET PENMOUNT=C:\PM2    (e.g. PenMount installation path is  
C:\PM2)
```

The driver can't be loaded, if the environment variable is not configured properly and the utility can't be run. Issue the command 'set' at DOS prompt to check the environment variable.

● **Environment Variable - PATH**

The installation program will put the installation path into the environment PATH. You can run program in any working directory at DOS prompt regardless of where the working directory is.

3.1.2. PenMount DOS Driver Functions

PenMount DOS driver offers several functions. You can change the settings with the following utilities:

1. PM2 Panel

Run the batch file 'PM2.EXE'. Type the command at DOS prompt:

```
PM2
```

Before running PM2, you must remove PenMount driver or another mouse driver, if you have installed one.

Chapter 3 *Installing Drivers for 6000 Boards*

There are several functions to select, and the launch key is in brackets. (e.g. press '2' key to do calibration)

Use <arrow key> (up/down) to select, and <Enter> to launch the following functions:

- (1) Draw
- (2) Calibrate
- (3) Detect
- (4) Configure
- (5) Packet
- (6) Help
- (7) Exit

2. Draw

Run the '**Draw**' in PM2 Panel, and use the arrow keys or hot keys (A~Y) to choose one of 25 video modes.

Video modes:

mode	width	height	colors
0Dh	320	200	16
13h	320	200	256
10Dh	320	200	32K
10Eh	320	200	64K
10Fh	320	200	16M
0Eh	640	200	16
10h	640	350	16
100h	640	400	256
12h	640	480	16
101h	640	480	256
110h	640	480	32K
111h	640	480	64K
112h	640	480	16M
103h	800	600	256
113h	800	600	32K
114h	800	600	64K
115h	800	600	16M
105h	800	768	256
116h	1024	768	32K
117h	1024	768	64K
118h	1024	768	16M
107h	1280	1024	256
119h	1280	1024	32K
11Ah	1280	1024	64K
11Bh	1280	1024	16M

There are several function keys in the drawing screen:

- [ESC]** - exit
- [Space]** - clear screen and information
- [F1]** - help, list the function keys
- [F2]** - style, toggle line or dot.

Installing Drivers for 6000 Boards

Line mode is default.

Dot mode is not to draw line between dot and next dot.

[F3] - frame, show / hide the frame

[F4] - dock, show / dock the status bar at bottom of screen

[F5] - pen color

There are 16 colors of pen color:

rainbow, blue, green, cyan, red, magenta, brown, lightgray, darkgray, lightblue, lightgreen, lightcyan, lightred, lightmagenta, yellow and white.

[F6] - highlight, highlight the dot in the line mode.

[F9] - camera, you can get the snapshot, and store it in bitmap file.

The filename is 'PM<HHMMSS>.BMP', <HHMMSS> is hour, minute and second. The resolution of bitmap file is the same as video mode, and the color depth is 4 bits. (16colors)

Status bar:

640x480 - screen resolution (320x200, 640x480....etc)

S: - number of dots were received per second.

Pen - pen color

P: - the counter of received dots

D: - the counter of pen down

U: - the counter of pen up

(x,y) - current coordinate of dot

x:y: - minimum value of coordinate

X:Y: - maximum value of coordinate

3. Calibrate

Run the 'Calibrate' in PM2 Panel, and choose one of the 25 video modes.

The purpose of calibration is to adjust the touchscreen mapping to properly meet the display screen.

You will be asked to select a video mode number. Select your display mode by using keyboard to start calibration.

Touch the upper point, then touch the right point, bottom point and left point, and press **<Enter>** key to pass the point. After calibration, the calibrated data will be showed in the screen.

After calibration, we recommend you to do drawing test to verify the touchscreen and monitor mapped properly.

Function Keys:

[Enter] - pass current point

[F9] - camera, see above.

4. Detect

Detect PenMount automatically. You can press any key to interrupt the

detection.

Use the following list to detect PenMount:

COM1 (Base 03F8) (Baud 19200): IRQ 3, 4
COM2 (Base 03F8) (Baud 19200): IRQ 3, 4
COM3 (Base 03F8) (Baud 19200): IRQ 3, 4, 5, 6, 7, 8, 9, 10, 11, 12, 13, 14, 15
COM4 (Base 03F8) (Baud 19200): IRQ 3, 4, 5, 6, 7, 8, 9, 10, 11, 12, 13, 14, 15
COM1 (Base 03F8) (Baud 9600): IRQ 3, 4
COM2 (Base 03F8) (Baud 9600): IRQ 3, 4
COM3 (Base 03F8) (Baud 9600): IRQ 3, 4, 5, 6, 7, 8, 9, 10, 11, 12, 13, 14, 15
COM4 (Base 03F8) (Baud 9600): IRQ 3, 4, 5, 6, 7, 8, 9, 10, 11, 12, 13, 14, 15

If you cannot find the PenMount, come 'configure' to set your COM port.

5. Configure

COM Port: COM5~COM9 is for setting customization.
IRQ no.: IRQ3~IRQ15
I/O base: COM1~COM4 are fixed while COM5~COM9 are for customization.
Baud: 19200 / 9600
Calibrate: left, right, top, and bottom point.
POMODE: the relationship between touch panel and monitor.
Beep Duration: beep duration time (0ms~5500ms), 0ms = turn off the beep
Beep Freq: beep frequency (20Hz ~10000 Hz)

Other configurations for customization in PenMount 6000:

. jitter threshold
. SSD threshold
. Z threshold
. pen-up threshold
. digital filter

Function Key:

[ESC] - exit
[Tab] - toggle the fields
[up] - increase value
[down] - decrease value
[right] - increase value by 100 (Beep Freq)
[left] - decrease value by 100 (Beep Freq)
[Enter] - save configuration and exit

6. Packet

By using this function, you can get the touch data. Simply touch the screen and you will see the data gotten.

Installing Drivers for 6000 Boards

The output format is as follows:

<counter> : counter of raw data
* : current dot
<raw data> : the raw data of touch
<coordinate>: the X, Y of A/D
<offset> : the offset between last dot

Function Key:

[ESC] - exit

7. Help

See 'README.TXT' file

8. Test

Before test, make sure the driver is loaded.

<1> The test program is named 'MOUSETST.EXE'. You can run it with parameter:

MOUSETST 18

The parameter is video mode number:

mode 18 (12h) : 640x480x16color

mode 19 (13h) : 320x240x256color

....

or run:

MOUSETST

to see what the parameters are

<2> run pctest.exe

<3> edit

You can also run 'EDIT', the editor bundle in MS-DOS.

3.2. Install PenMount Windows Universal Driver (for 2000/XP/XPT/XPE/2003/VISTA/7/WES7/2008/8)

Before installing **PenMount Windows Universal Driver**, you must have had installed one of the operating systems from Windows 2000/XP/XPT/XPE/2003/VISTA/7/WES7/2008/8 in your computer, and one of PenMount control boards from 6200x, 6202B, 6300x, or 6500x must have been installed.

Before installing PenMount Windows Universal driver V2.4.0.306, you may modify the default options from \PenMount Universal Driver V2.4.0.306\Driver\Install.ini:

Install	USB	1. Install PenMount USB driver. 0. Uninstall PenMount USB driver.
	COM	1. Install PenMount RS232 driver. 0. Uninstall PenMount RS232 driver.
	MMonitor	1. Install PenMount driver for multi- device recognition. 0. Uninstall PenMount driver for multi- device recognition.
	ENUM	1. Install PenMount driver for Non- pnp device recognition. 0. Uninstall PenMount driver for Non- pnp device recognition.
Option	TouchReport	1. The default setting of Windows 2k/XP/Vista/7 is mouse mode. 2. The default setting of Windows 2k/XP is mouse mode; the default setting of Windows 7/ Vista is digitizer mode.
	EdgeOffset	0,5,10,15,20,25,30 are the default values for edge compensation.
	Smoothing	1. Turn on the smoothing function. 0. Turn off the smoothing function.
	Operation	The default settings of operating mode: 0. Pen Input Emulation 2. Mouse Emulation 1. Click on Touch 3. Click on Release
	CalibOffset	This function is unable to be modified.
	RBtnPressN Hold	0. Turn on long- pressed right key function. 1. Turn off long- pressed right key function.
Serial	ScanAllPorts	1. Turn on "Scan All Ports" to confirm PenMount RS232 device. 0. Turn off "Scan All Ports" for the confirmation of PenMount RS232 device.
	COM3=xxxx ,yyyy	To set up the permanent system COM port for PenMount RS232 driver. COM3- to correct it to be correspondent with the actual COM PORT. xxxx- the supporting item number: 9000/ 6000 or PCI. yyyy- the baud rate 19200 or 9600 of item 6000 or item 9000; baud rate 38400 is only for PCI items. # Please note that the information above must be correct, so that the device can just work normally, and ENUM must be set as 1. Example: COM1= PCI, 38400 # Permanently install PCI RS232 38400bps at COM1 COM3= 6000,19200 #Permanently install PM6000 RS-232 19200bps at COM3 COM4=9000,9600 #Permanently install PM9000 RS-232 9600bps at COM4
PS. Set the symbol";" in front of the parameter, which means not to perform the parameter. Example: ; TouchReport =2 , it will not be installed as Digitizer mode directly in Windows 7, the user can select Digitizer or mouse mode during the installation procedure. ; COM1=PCI,38400 , it will not install the driver at COM1 permanently.		

3.2.1. Install PenMount Mouse Driver in Windows 2000/XP/XPT/XPE/2003/VISTA/7/WES7/2008/8

If you have an older PenMount driver installed on your system, uninstall it first and follow the steps below to install **PenMount Windows Universal Driver**:

Plug in your PenMount 6000 control board and install **PenMount Windows Universal Driver**. Make sure the driver is installed before control board is plugged. Then the driver will have the assigned COM port or USB port detect PenMount device.



To install the driver:

1. In folder **PenMount Universal Driver**, find **“Setup.exe”** and run it.
2. A **License Agreement** window appears. Click **“I Agree”** and **“Next”**.
3. When ready to install the program, click **“Install”**.
4. Installation takes some time.
5. When the warning message screen appears, please click **“Continue Anyway”** to continue.

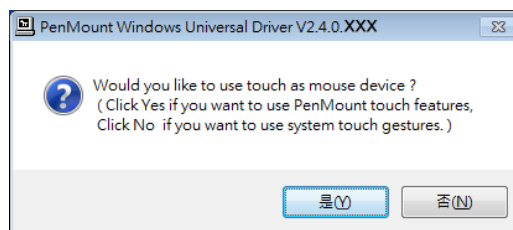

6. When the window below shows up, please select “yes” for installing PenMount as mouse mode; select “no” for digitizer mode. If your operating system doesn’t support Windows tablet input, digitizer device can’t be used, therefore you have to select “yes” here, otherwise after the installation the touch doesn’t work after re-booting.



7. A window notifying of installation completion appears. Click **“Finish”**.
NOTE: If you are installing the driver with Microsoft WHQL, you will see the screen in step 6 directly instead of step 5.
8. Then restart operating system.
As soon as driver installation finishes, both the icons of **PenMount Monitor**  and **Gesture AP**  show up in the notification area.



3.2.2. Install PenMount Digitizer Driver in Windows XPT/VISTA/7/ WES7/2008/8

The installation steps of the default settings are consistent with XP. When you select “no” for step 6, PenMount will be installed as a digitizer device; If your operating system doesn’t support Windows tablet input, digitizer device can’t be used, therefore you have to select “yes” here, otherwise after the installation the touch doesn’t work after re-booting.

After the installation, you will see the difference that a **PenMount Control Panel** icon shows up on the desktop without a  icon in the notification area. See the screenshot below:

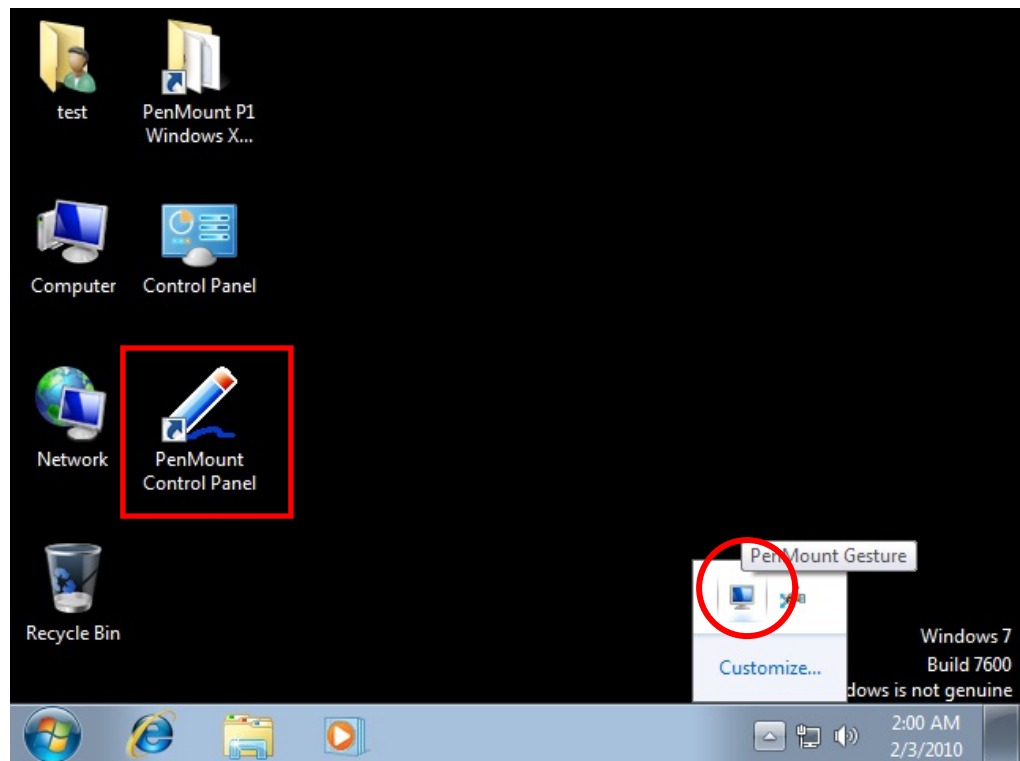

3.2.3. Configure Touchscreen In PenMount mouse driver

Click on the **PenMount Monitor** icon  in the notification area and select **Control Panel** from the menu.



On **PenMount Control Panel** you are able to see the device of PenMount 6000 USB/RS-232 detected by your system under **Device** tab. Select a device and click the **Configure** button.

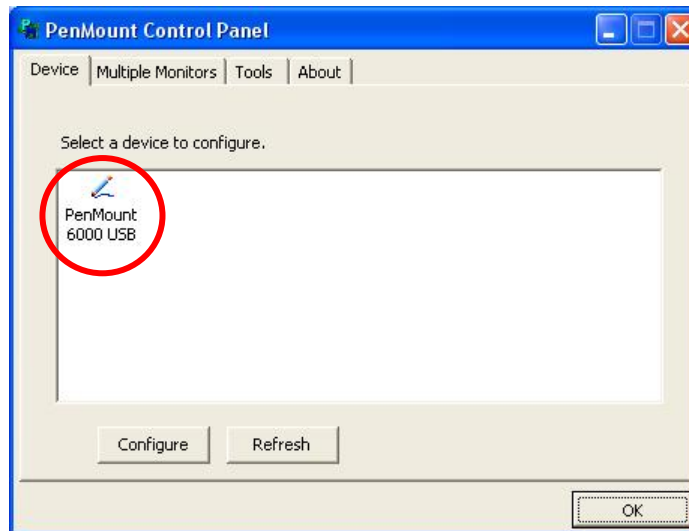

3.2.3.1 PenMount Control Panel

The functions under **PenMount Control Panel** are:

Device

In this window, you can find out how many devices are detected by your system.

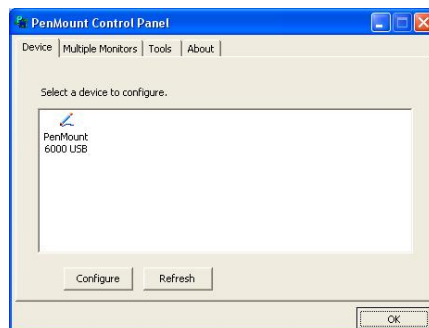

Calibrate

This function offers two ways to calibrate your touchscreen. '**Standard Calibration**' adjusts most touchscreens while '**Advanced Calibration**' adjusts aging touchscreens.

Standard Calibration

Click this button and arrows appear pointing to red squares. Use your finger or stylus to touch the red squares in sequence. After the fifth red point calibration is complete. To skip, press '**ESC**'.

Advanced Calibration

Advanced Calibration uses 9, 16 or 25 points to effectively calibrate touch panel linearity of aged touchscreens. Click this button and touch the red squares in sequence with a stylus. To skip, press '**ESC**'.

Chapter 3 Installing Drivers for 6000 Boards

Command Calibration

Command call calibration function. Use command mode call calibration function, this can uses 4, 9, 16 or 25 points to calibrate.

E.g. Please run ms-dos prompt or command prompt.
c:\Program Files\PenMount Universal Driver\DMCCtrl.exe
-calibration 4 (Standard Calibration)

DMCCtrl.exe - calibration (\$)
4= Standard Calibration 4
9= Advanced Calibration 9
16= Advanced Calibration 16
25= Advanced Calibration 25

To calibrate your touchscreen:

1. Please select a device then click **“Configure”**. You can also double click the device too.

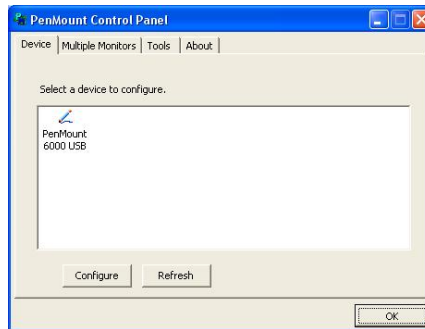

2. Click **“Standard Calibration”** to start standard calibration or **“Advanced Calibration”** to start Advanced Calibration.

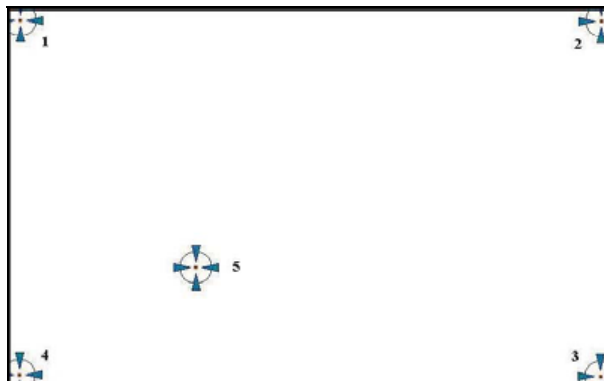
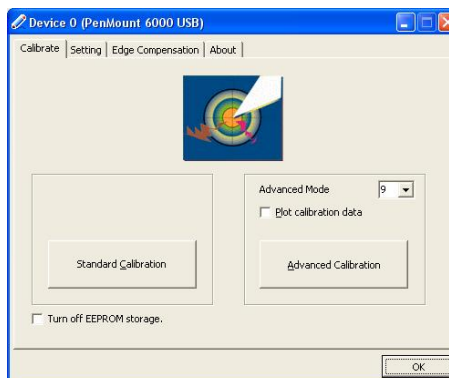

Installing Drivers for 6000 Boards

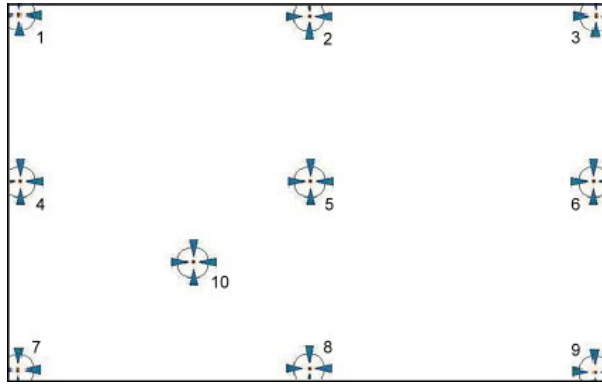

NOTE : The older a touchscreen is, the more calibration points of the **Advanced Mode** it needs. For an optimal accuracy we suggest to use a stylus to make the advanced calibration.

Plot Calibration Data

Check this function to have touch panel linearity comparison graph appear when you finish **Advanced Calibration**. The black lines reflect the ideal linearity assumed by PenMount's application program while the blue lines show the approximate linearity calculated by PenMount's application program as the result of user's execution of **Advance Calibration**.

Turn off EEPROM storage

This function disables the write-in of calibration data in **Controller**. This function is enabled by default.

Setting

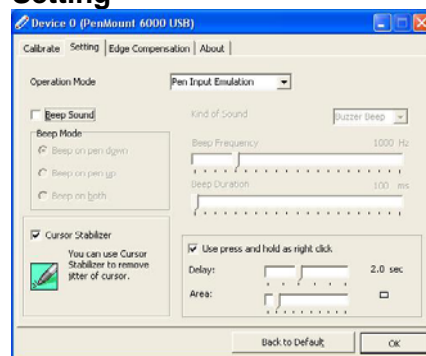

Operation Mode

This mode enables and disables mouse's ability of dragging on-screen icons—useful for configuring POS terminals.

Pen Input Emulation

Select this mode and mouse will emulate Windows Vista pen input device operation, by which no mouse event will be sent until the touch is dragged out of range or released from the screen.

Mouse Emulation

Select this mode and mouse functions as normal and allows dragging of icons.

Chapter 3 Installing Drivers for 6000 Boards

Click on Touch Select this mode and mouse only provides a click function, and dragging is disabled.

Click on Release Select this mode and mouse only provides a click function when the touch is released.

Beep Sound **Enable Beep Sound** – turns beep function on and off.

Beep on Pen Down – beep occurs when pen comes down.

Beep on Pen Up – beep occurs when pen is lifted up.

Beep on both – beep occurs when comes down and is lifted up.

Beep Frequency – modifies sound frequency.

Beep Duration – modifies sound duration.

Cursor Stabilizer Enable the function support to prevent cursor shake.

Use press and hold as right click You can set the time out and area for you need

Edge Compensation

This page is the edge compensation settings. You can adjust the settings from 0 to 30 for accommodating the difference of each touch panel.

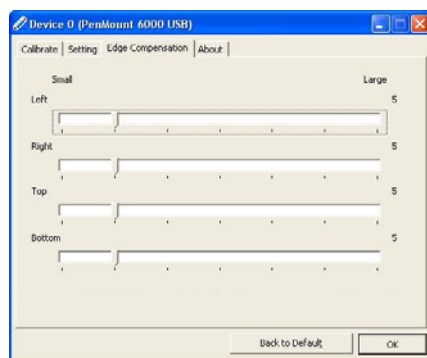

About

This panel displays information about the PenMount controller and driver version

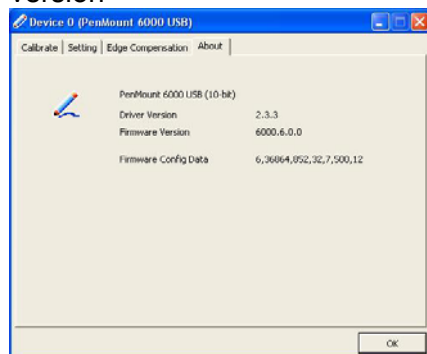

3.2.3.2 PenMount Monitor Menu Icon

PenMount Monitor icon (PM) appears in the notification area of Windows system when you turn on **PenMount Monitor** in **PenMount** utility.



PenMount Monitor has the following functions:



Control Panel Open PenMount **Control Panel**.

Beep Setting **Beep** function for each device.

Right Button When you select this function, a mouse icon appears in the right-bottom of the screen. Click this icon to switch between **Right** and **Left Button** functions.

Exit Exits the **PenMount Monitor** function.

3.2.3.3 PenMount Rotating Function

PenMount Windows Universal Driver supports several display rotating software packages and auto-detects rotate function (0°, 90°, 180°, 270°). The display rotating software package supported in Windows 2000, XP 32bit, Vista 32/64bit are:

1. Intel Display Driver Rotate Function.
2. ATI Display Driver Rotate Function.
3. nVidia Display Driver Rotate Function.
4. SMI Display Driver Rotate Function.
5. Portrait's Pivot Screen Rotation Software.

Configure Rotate Function in Windows XP 64bit

1. There is a "**Screen Rotation Monitor**" button that appears only in the PenMount driver utilities for Windows XP 64bit system.

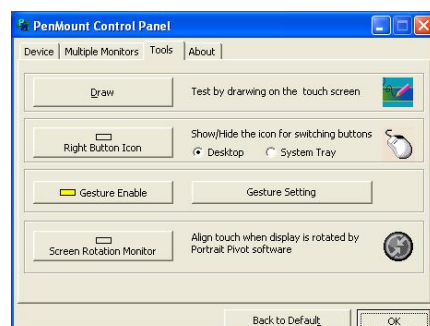

2. On enabling “**Screen Rotation Monitor**”, you will see a screen like below:

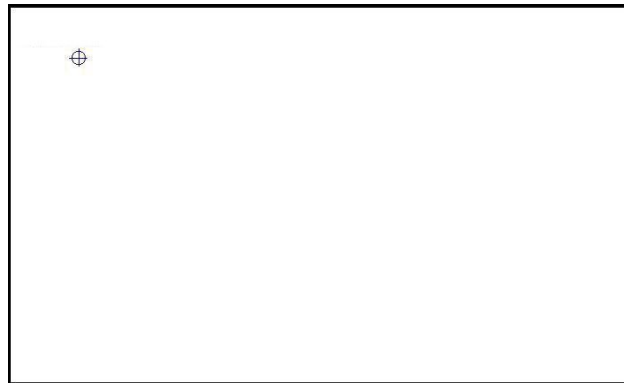

3. Choose rotate function (0°, 90°, 180°, 270°) in the 3rd party software. The calibration screen will appear automatically. Touch this point and rotation is mapped.

NOTE: Rotate function is disabled if you use **Monitor Mapping**.

3.2.4. The Touchscreen Configure of PenMount Digitizer Driver

With PenMount Windows Universal V2.2.0.283 and the later versions, since the touchscreen is automatically installed as a digitizer device in Windows Vista/7, the functions built in Windows Vista / 7 such as rotation, multi-monitor, flicks, and context menu function (which launches a context menu by user’s long-pressing on touchscreen rather than clicking the right mouse button or pressing the application key on the keyboard) will be supported.

To configure touchscreen in PenMount Digitizer driver:

Double-click on the **PenMount Control Panel** icon on the Desktop.



On **PenMount Control Panel** you are able to see the device of PenMount 6000 USB/RS-232 detected by your system under **Device** tab. Select a device and click the **Configure** button.

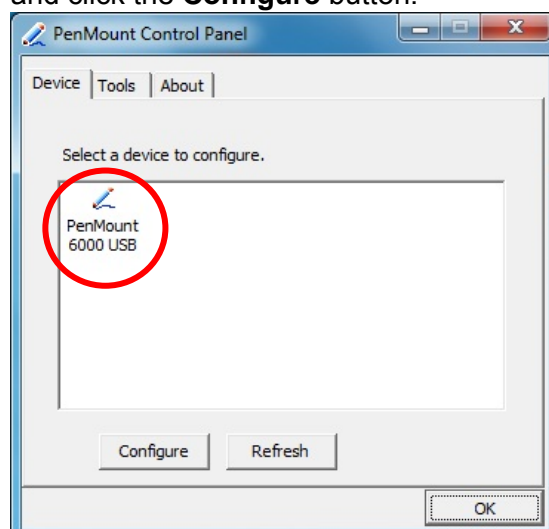

3.2.4.1. PenMount Control Panel

The functions under **PenMount Control Panel** are:

Device

In this window, you can find out how many devices are detected on your system.

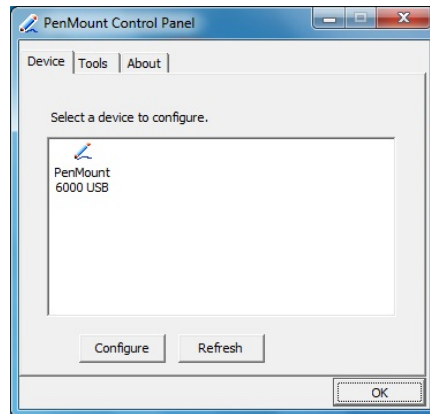

Calibrate

This function offers two ways to calibrate your touchscreen. '**Standard Calibration**' adjusts most touchscreens while '**Advanced Calibration**' adjusts aging touchscreens.

Standard Calibration

Click this button and arrows appear pointing to red squares. Use your finger or stylus to touch the red squares in sequence. After the fifth red point calibration is complete. To skip, press '**ESC**'.

Advanced Calibration

Advanced Calibration uses 9, 16 or 25 points to effectively calibrate touch panel linearity of aged touchscreens. Click this button and touch the red squares in sequence with a stylus. To skip, press '**ESC**'.

Command Calibration

Command call calibration function. Use command mode call calibration function, this can uses 4, 9, 16 or 25 points to calibrate.

E.g. Please run ms-dos prompt or command prompt.
c:\Program Files\PenMount Universal Driver\DMCCtrl.exe
-calibration 4 (Standard Calibration)

DMCCtrl.exe - calibration (\$)
4= Standard Calibration 4
9= Advanced Calibration 9
16= Advanced Calibration 16
25= Advanced Calibration 25

Chapter 3 Installing Drivers for 6000 Boards

To calibrate your touchscreen:

1. Please select a device then click “**Configure**”. You can also double click the device too.

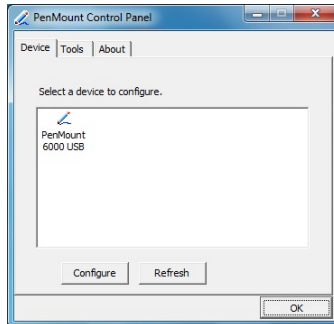

2. Click “**Standard Calibration**” to start standard calibration or “**Advanced Calibration**” to start Advanced Calibration.

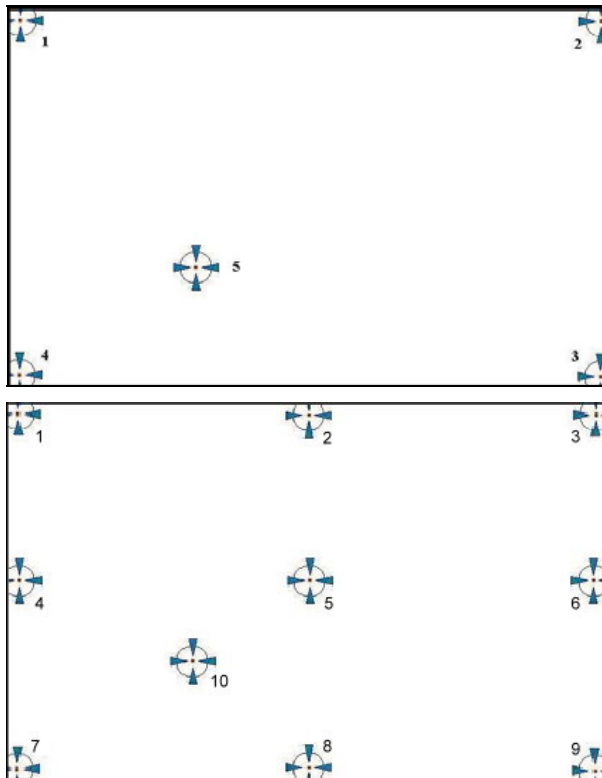
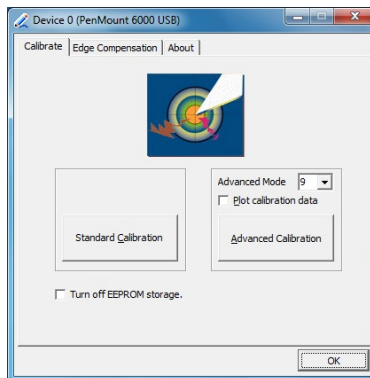

NOTE : The older a touchscreen is, the more calibration points of the **Advanced Mode** it needs. For an optimal accuracy we suggest to use a stylus to make the advanced calibration.

Installing Drivers for 6000 Boards

Plot Calibration Data

Check this function to have touch panel linearity comparison graph appear when you finish **Advanced Calibration**. The black lines reflect the ideal linearity assumed by PenMount's application program while the blue lines show the approximate linearity calculated by PenMount's application program as the result of user's execution of **Advance Calibration**.

Turn off EEPROM storage

This function disables the write-in of calibration data in **Controller**. This function is enabled by default.

Edge Compensation

This page is the edge compensation settings. You can adjust the settings from 0 to 30 for accommodating the difference of each touch panel.

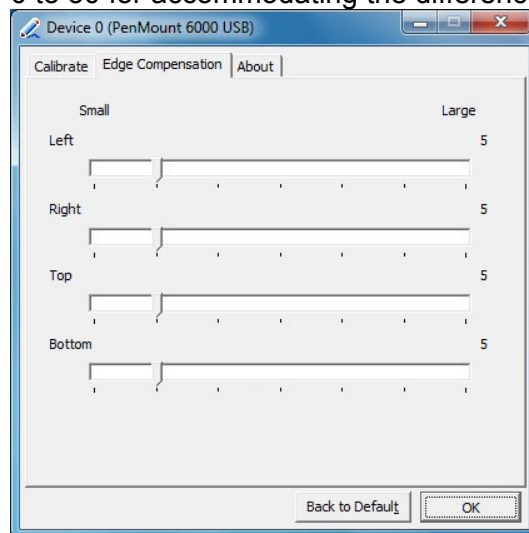

About

This panel displays information about the PenMount controller and driver version

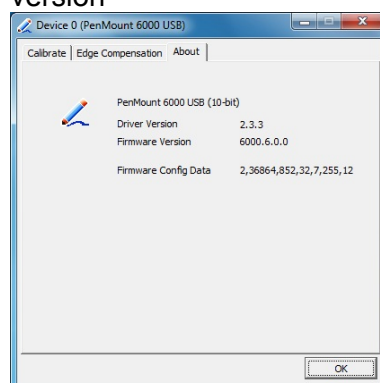

3.2.5. Uninstall PenMount Windows Universal Driver

1. Go to **Control Panel**. Click **"Add/Remove program"**. Select **"PenMount Universal Driver"**. Click **"Change/Remove"** button.

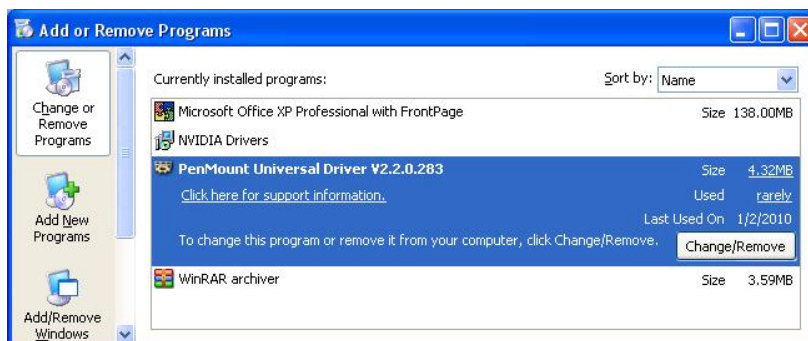

2. Select **'Uninstall'** to remove **PenMount Windows Universal Driver**.

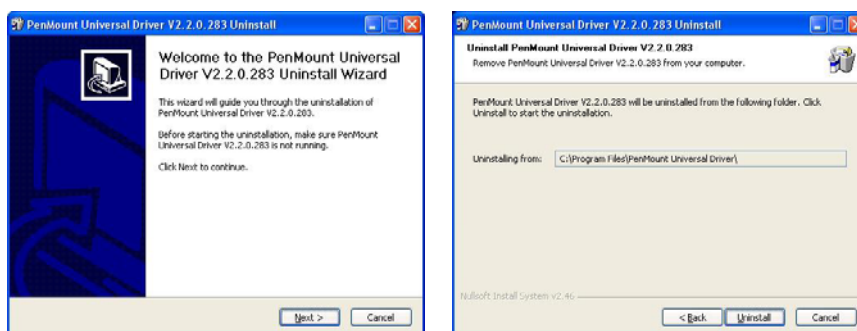

3.3. Install PenMount Linux X Window RS-232/USB Driver

Before installing **PenMount Linux X Window RS-232/USB Driver** for PenMount 6000 boards, you must have had Linux X Window installed and running on your computer. **You must also have installed one of PenMount 6200D, 6202B, 6300A or 6500A control boards.**

PenMount Linux X Window RS-232 and USB Drivers for 6000 boards support the following operating systems:

	RS232	USB
Ubuntu 6.06/ 6.10/ 7.04/ 7.10/ 8.04/ 8.10/ 9.04/ 9.10/ 10.04/ 10.10/ 11.04/ 11.10/12.04 32_64bit	•	•
Debian 4.0/ 5.0 32_64bit/ 6.0	•	•
Debian 3.1		
Fedora 4/5/6/7/8/9/10/11/12/13 /14/15/16/17 32_64bit	•	•
Fedora Core4_64bit		
Fedora Core3	•	
Fedora Core2	•	
Slackware12.0/12.1	•	•
Slackware10.0		

Installing Drivers for 6000 Boards

Red Hat 9.0	•	
Red Hat 7.3/8.0	•	•
OpenSuse 10.1/ 10.2/ 10.3/ 11/ 11.1/ 11.2/ 11.3/ 11.4/ 12.1 32_64bit	•	•
Suse 10.0	•	
Suse 9.2/9.3		
Suse 8.0/9.0/9.1		
Cent OS 5.2/ 5.3/ 5.4/ 5.5/ 6.0/ 6.2 32_64bit	•	•
Linux XFree86 4.x.x		
Linux XFree86 3.3.6		
Linux For GPM	•	•
QNX 6.4.1/ 6.5	•	•
QNX 6.3.2		
QNX 6.2	•	
Android	•	•

3.3.1. Install PenMount Linux X Window RS-232 Driver and USB Driver

See the readme file included in the driver folder.

3.3.2. Calibration Utilities

See the readme file included in the driver folder.

3.4. Install PenMount WinCE Driver

Before installing **PenMount WinCE Driver**, you must have WinCE system installed and running in your device. You must also have had either PenMount USB control boards 6200D, 6202B, 6300A or 6500A installed.

NOTE: Make sure you can move the WinCE cursor with a serial mouse attached to the target COM port (e.g. COM2) before connecting the 6000 control board by RS-232 port.

3.4.1. Install PenMount WinCE Driver

Please see the readme file included in the driver folder.

Chapter 4. Driver Software Functions

This chapter will guide you to the special software functions that configure and adjust the PenMount control boards and touchscreen hardware. Please note that not all of the functions are available for every driver. See the following table for drivers' software functions and their availability for specific interface and systems:

Software Function	DOS	2000/XP/2003	VISTA/7/8	WinCE	Linux
Standard Calibration	•	•	•	•	•
Advanced Calibration		•	•	•	•
Multiple Monitors		•	•		
Multi Device		•	•		
Rotation		•	•		
Operation Mode		•	•		
Drawing mode	•	•	•	•	
Beep Sound	•	•	•		•
Beep sound adjustable		•	•		
Wake up function		•	•		
Showing linearity		•	•		
Right button		•	•	•	•
Hide cursor	•				
Double click area and speed adjustable		•	•		
About		•	•		
Edge Compensation		•	•		
Refresh		•	•		

Remark: With PenMount Windows Universal V2.2.0.283 and later versions, since the touchscreen is automatically installed as a digitizer device in Windows Vista/7/8, the functions which are built within Windows Vista/7/8 such as rotation, multi-monitors, flicks, and context menu function (which launches a context menu by user's long-pressing on touchscreen rather than clicking the right-mouse button or pressing the application key on the keyboard) will be supported.

The following content in this chapter deals mainly with **PenMount Windows Universal Driver (for 2000/XP/2003/VISTA/7/8)**. For this driver, the function of **Tools** should be made known to you first. When you click the PenMount icon in the notification area and select **“Control Panel”** from the menu, **“PenMount Control Panel”** with the four tags **“Device”**, **“Multiple-Monitors”**, **“Tools”**, **“About”** will appear as the screenshot below:

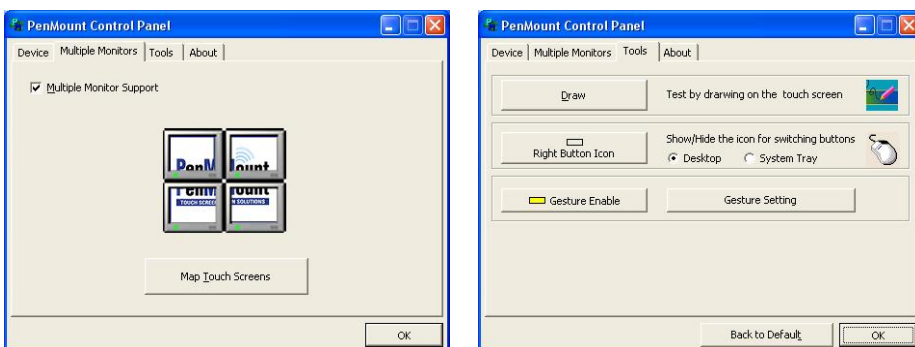

Chapter 4 Driver Software Functions

The buttons on such “**PenMount Control Panel**” have the following functions:

Draw	Tests or demonstrates the PenMount touchscreen operation.
Right Button Icon	Enable right button function. The icon can show on Desktop or in the notification area .
Gesture Enable	Enable/configure Gesture AP to support PenMount gestures recognition.
Screen Rotation Monitor	The function supports nVidia , Intel , SMI or ATI and software such as Portrait Pivot Pro rotation automatic detection.

4.1. Standard Calibration

Standard Calibration function lets you match the touchscreen to your display so that the point you touch is accurately tracked on screen. **Standard Calibration** only requires four points for calibration and one point for confirmation. Under normal circumstance **Standard Calibration** is all you need to perform an accurate calibration.

4.2. Advanced Calibration

Advanced Calibration function improves the accuracy of calibration by using more involved engineering calculations. Use this function only if you have tried the **Standard Calibration** and there is still a discrepancy in the way the touchscreen maps to the display. You can choose 9, 16 or 25 points to calibrate, though we suggest that you first try 9 points, if it is still not tracking well then try 16 or 25 points. The more points you use for calibration, the greater the accuracy. Errors in calibration may occur due to viewing angle, or individual skill, and there may be little difference in using 16 or 25 points. Note that a stylus is recommended for the most accurate results.

4.3. Multiple Monitors

Multiple Monitors supports two to six touchscreen displays for one system. PenMount drivers for Windows 2000, XP 32/64bit, and 2003 support **Multiple Monitors**. This function supports from two to six touchscreen displays for one system. Each monitor requires its own PenMount touchscreen control board, either installed inside the display or in a central unit. The PenMount control boards must be connected to the computer COM ports via the RS-232 interface. Driver installation procedures are the same as for a single monitor. Multiple Monitors supports the following modes:

Windows Extend Monitor Function
Matrox DualHead Multi-Screen Function
nVidia nView Function

NOTE: The **Multiple Monitors** function is for the use with multiple displays only. Do not use this function if you have only one touchscreen display. Please note once you turn on this function the **Rotating** function is disabled.

4.3.1. Requirements

Before using the **Multiple Monitors** function you need the following:

- A display card that supports multiple monitors such as the Matrox, nVidia, ATI, etc.
- (Two or more display cards supported by Windows are also ok.)
- Two or more touchscreens
- Two or more Serial Ports or USB ports.
- Two or more PenMount 6000 control boards such as 6200D, 6202B, 6300A or 6500A.
- The PenMount Windows Universal Driver (for 2000/XP/2003/VISTA/7/8).

Before using **Multiple Monitors** you must have two or more monitors that are in extension mode. For display cards that support multiple monitors, we suggest you consider Matrox, nVidia, or ATI cards and inquire about operation and usability issues.

Note: Before you can use multiple monitors you need to map each monitor.

Enable the Multiple Monitors

Enable the multiple display function as follows:

1. In PenMount **Control Panel**, under **Multiple Monitors** tag, check the “**Multiple Monitor Support**” box. Then click “**Map Touchscreens**” to assign touch controllers to displays.

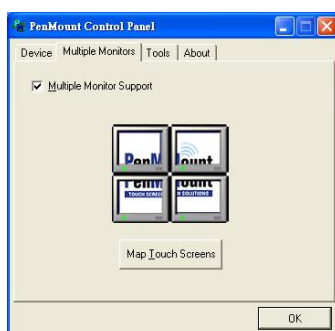

2. When the mapping screen message appears, click “**OK**”.

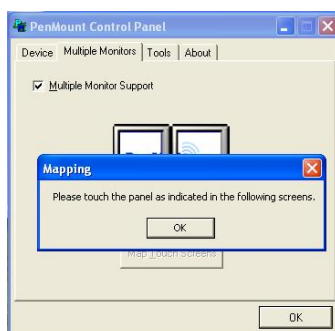

Chapter 4 Driver Software Functions

3. Touch each screen as it displays "Please touch this monitor. Press 'S' to skip". Follow this sequence and touch each screen to map the touchscreens.

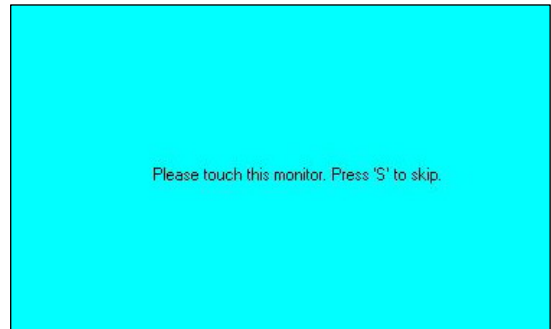

4. After the setting procedure is finished, maybe you need to calibrate for each panel and controller.

NOTES:

1. If you use a single VGA output for multiple monitors, please do not use the **Multiple Monitors** function. Just follow the regular procedure for calibration on each of your desktop monitors.
2. The **Rotating** function is disabled if you use the **Multiple Monitors** function.
3. If you change the resolution of display or screen address, you have to redo **Map Touchscreens** so the system understands where the displays are.
4. If you have multiple monitors but only one touchscreen, press 'S' to skip mapping step.

4.3.2. An Example for 2 Units of Touch Monitor

1. Please make sure the touch monitor had plugged in and detected.





2. In PenMount **Control Panel**, under **Multiple Monitors** tag, click “**Map Touchscreens**” then click “**OK**”.

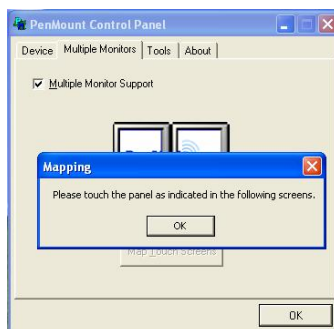

3. Please follow the message show the display to match the controller and touchscreen.

3-1. Please click “**S**” to skip if the monitor without use touchscreen.

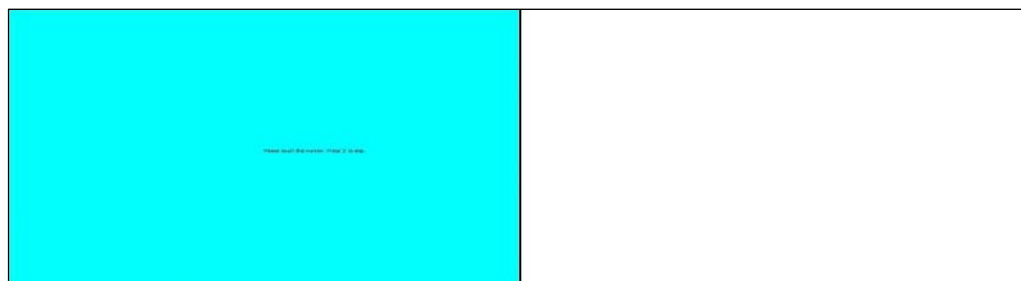

3-2. When screen jump to Screen 2, please touch it. If screen 2 has no touch function, press “**S**” to skip it.

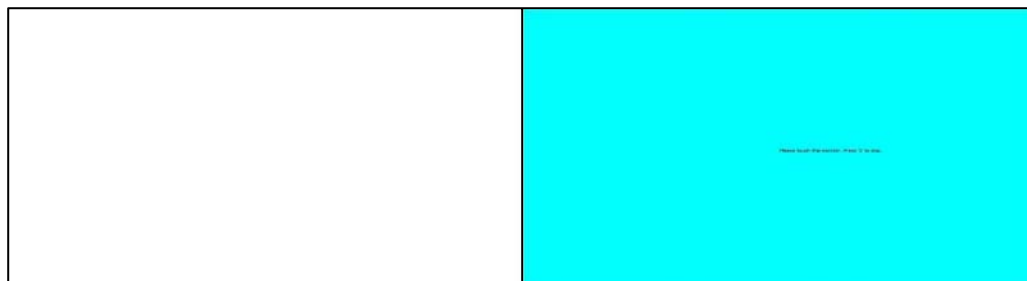

Chapter 4 Driver Software Functions

4. Before proceeding to calibrate, you have to finish the procedure of “**Map touchscreens**”.

4-1. Please do the calibration for each device in sequence.

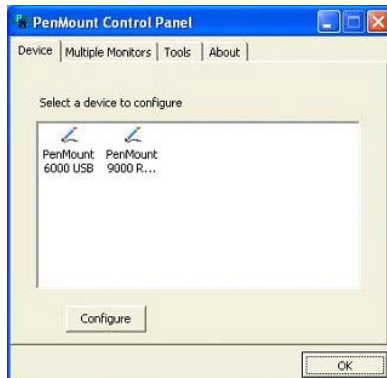

4-2. Press each device & start to do **Standard Calibration**, for instance, device 0.



4-3. After you press device 0, one of screens will show calibration map. Please follow the points to calibrate it. When you completed one device, please do others with the same way.

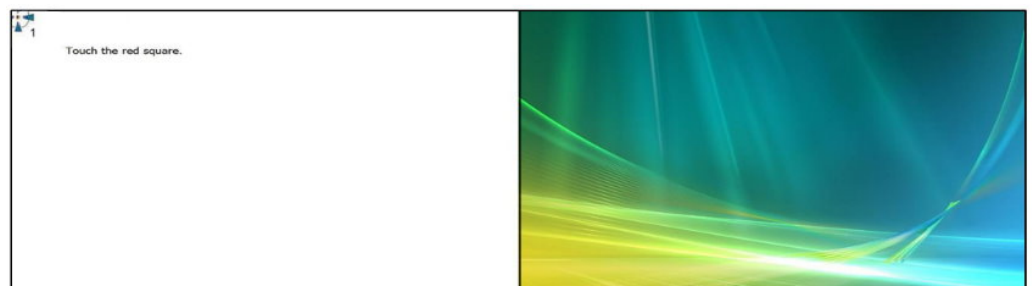

4.4. Multiple Devices

Multiple Devices function is designed to let you use two or more monitors to display the same image. Software that supports this function includes the PenMount Windows Universal Driver (for 2000/XP/2003/VISTA/7/8) only. This driver for PenMount 6000 can support up to sixteen control boards.

4.4.1. Compare Functions

The difference between the **Multiple Monitors** function and the **Multiple Devices** function are illustrated below.

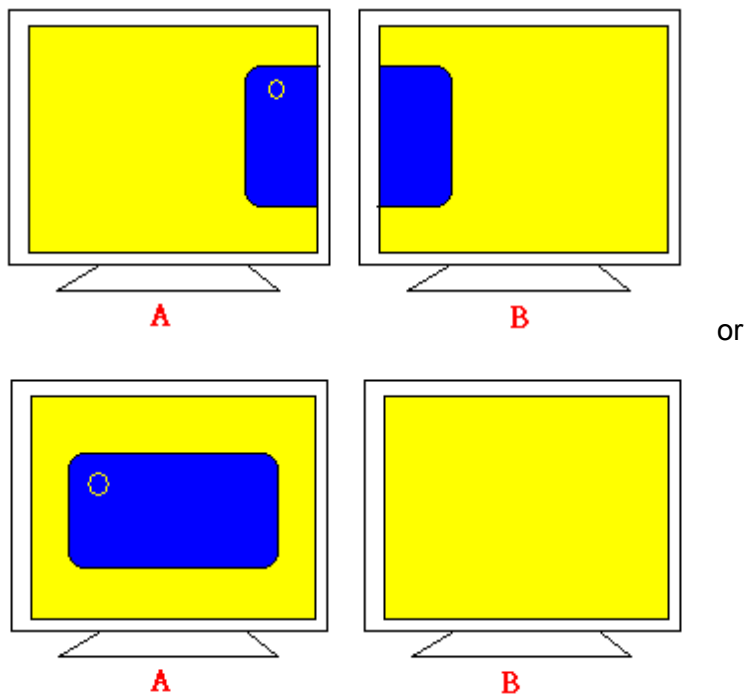

Multiple Monitors function shown above extends the screen into 2 or more monitors.

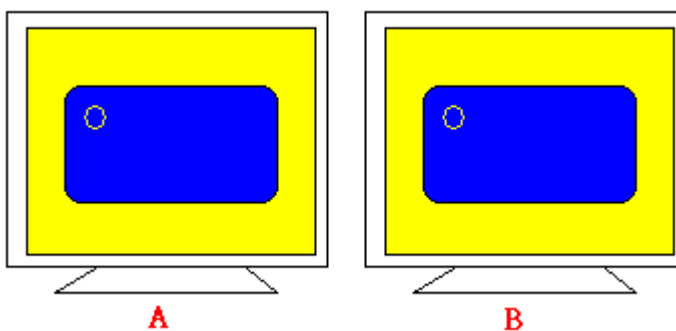

Multiple Devices function displays the same image on two or more monitors.

4.4.2. Requirements

To use **Multiple Devices** with 6000 Control Boards, you need to do the following:

To connect with RS-232 ports:

1. Configure your computer hardware. See **Chapter 2. Install PenMount 6000 Control Boards.**
2. Attach each 6000 board to a different computer's serial port.
3. Install the PenMount Windows Universal Driver (for 2000/XP/2003/VISTA/7) in each computer – see **Chapter 3. Install Drivers for 6000 Boards** for details.

Chapter 4 Driver Software Functions

4. Use driver's **Calibration** function to calibrate each computer's touchscreen. You must calibrate each touchscreen before configuration is complete.

To connect with USB ports:

1. Configure your computer hardware and the Control Board ID Dipswitch – refer to your control board's hardware description in **Chapter 2. Install PenMount 6000 Control Boards**.
2. Install the PenMount Windows Universal Driver (for 2000/XP/2003/VISTA/7) in each computer – see **Chapter 3. Install Drivers for 6000 Boards** for details.
3. Use driver's Calibration function to calibrate each computer's touchscreen. You must calibrate each touchscreen before configuration is complete.

Note: Be sure to set the Control Board ID Dipswitches. Do not use the same setting on different control boards; otherwise the hardware will not operate correctly.

4.5. Rotation

There are currently a number of software packages on the market that support rotating monitors 0°, 90°, 180°, and 270°. However you will not be able to use a touchscreen unless it is matched to the appropriate rotation. Our rotation configuration function allows you to easily match the touchscreen when you rotate your monitor.

If you use a rotating monitor you will need a display card such as from **nVidia, Intel, SMI** or **ATI** and software such as **Portrait Pivot Pro**. For software operation and features, please refer to your software manual.

Configuring the rotation function is easy. Select this option and a 'point' appears for you to touch. Once the point is touched the software driver understands which degree you plan to rotate your display. The rotation function supports 90, 180 and 270 degrees rotation.

4.6. Draw

Tests or demonstrates the PenMount touchscreen operation. The display shows touch location. Click **Draw** to start. Touch the screen with your finger or a stylus and the drawing screen registers touch activity such **left, right, up, down, pen up, and pen down**.

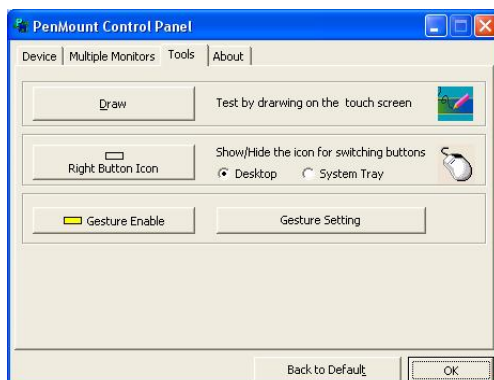

Touch the screen with your finger or a stylus and the drawing screen registers touch activity such **left, right, up, down, pen up, and pen down.**



Click **Menu** button for more functions.

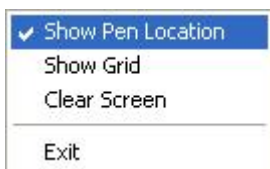

Show Pen Location is to show the locations where pen comes down and lifted up on the monitor.

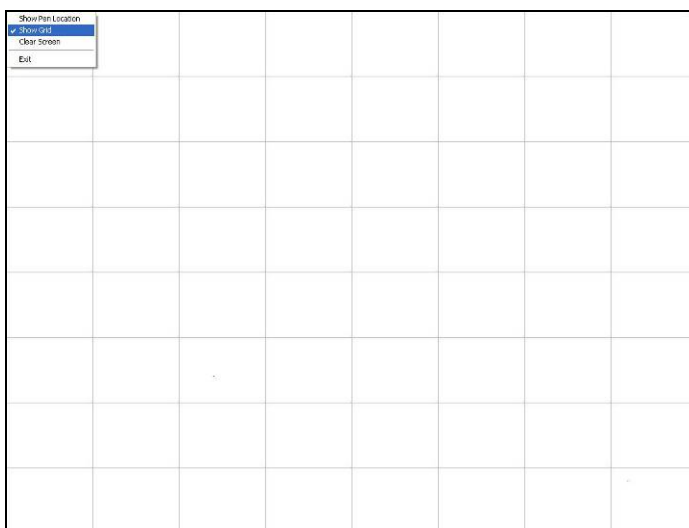

Show Grid is to show grid on the entire monitor. This is for linearity test.



Select **Clear Screen** to clear drawing.



Select **Exit** to quit draw function

4.7. Mouse Operation Mode

Mouse Operation Mode enables and disables mouse's ability of dragging onscreen icons, which is applicable to the configuration of POS terminals.

Pen Input Emulation – Select this mode and mouse will emulate Windows Vista pen input device operation, by which no mouse event will be sent until the touch is dragged out of range or released from the screen.

Mouse Emulation – Select this mode and mouse functions as normal and allows dragging of icons.

Click on Touch – Select this mode and mouse only provides a click function, and dragging is disabled.

Click on Release – Select this mode and mouse only provides a click function when the touch is released.

4.8. Beep Sound

All of PenMount's drivers support the beep sound function; however some PC systems may only offer a fixed buzzer sound.

4.9. Beep Sound Adjustable

Software drivers for Windows systems let the user adjust the frequency and length of the beep sound. The drivers let the user adjust the desired touchscreen sound, as well as turn the sound off.

4.10. Wake Up Function

Wake Up function lets the user touch the screen and wake the system up from 'suspend' mode.

4.11. Plot Calibration Data

Plot Calibration Data function displays the touchscreen linearity map, which is available if the PenMount driver provides an **Advance Calibration** function. When touchscreens age their touch linearity declines. This non-linearity is apparent when the touched point on the touchscreen is not the same as the point on the display. The **Plot Calibration Data** function shows the linearity status of the touchscreen. This is only a support function for the user. The exact linearity of a touchscreen requires a linearity test machine.

4.12. Right Button

Right Button function simulates the right button function of a mouse. Click the right button and the user can only touch the screen once and the driver changes the touch definition to the left button.

4.13. Hide Cursor

Hide Cursor function keeps the cursor arrow and other cursor symbols from appearing when using the touchscreen. The cursor appears when user turns this function off.

4.14. Cursor Offset

Cursor Offset function lets the user adjust the position of the touch point to a desired location away from the real touch point.

4.15. Double Click Area and Speed

Double Click Area and Speed function lets the user adjust the double click area and speed to their personal preference.

4.16. About

This option shows the exact version of the drivers and controller firmware. Updated drivers are available for downloading on the PenMount website at <http://www.penmount.com/>.

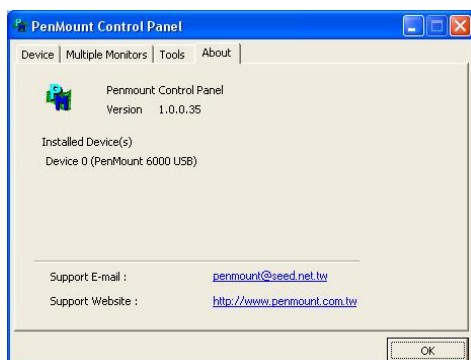

4.17. Edge Compensation

In PenMount **Control Panel**, when any of the detected PenMount device is selected and the **Configure** button is pressed, you will be able to see the **Edge Compensation** tag, which is for **Advanced Calibration**. You can adjust the settings from 0 to 30 for accommodating the difference of each touch panel. (Note: **Edge Compensation** is only supported by PenMount Windows Universal Driver (for Windows 2000/XP/2003/VISTA).)

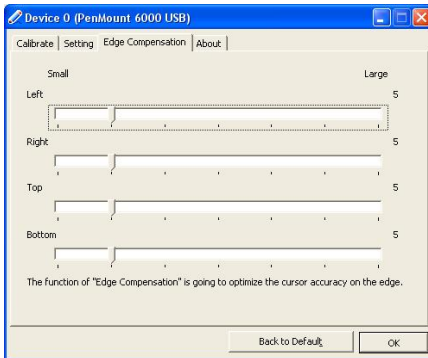

4.18. Refresh

If you installed PenMount driver package 2.1.0.187 and after, you can click the **Refresh** button on PenMount **Control Panel** to detect the newly attached PenMount devices. (Note: **Refresh** is only supported by PenMount Windows Universal Driver (for Windows 2000/XP/2003/VISTA).)

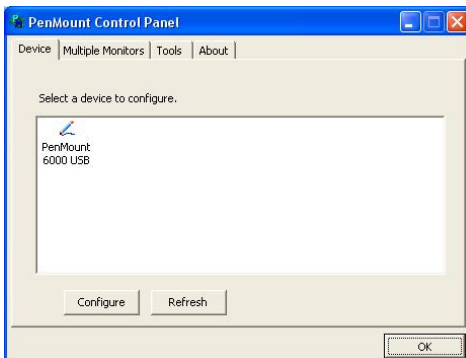

Chapter 5. PenMount Gesture AP for Windows 2000/XP/VISTA/7/8

This chapter will guide you to the PenMount Gesture AP that is applicable in Windows 2000/XP/Vista/7.

5.1. Invoke PenMount Gesture AP

1. Make sure you have installed PenMount touchscreen control boards (either 6000 or 9000 series).
2. Make sure you have installed PenMount Universal Driver V2.1.0.263 or later versions on your system.
3. To run PenMount Gesture AP.

In the notification, right-click on the PenMount icon and select **Gesture Enable** from the menu. A **PenMount Gesture AP** icon will show up in the notification area. See the illustration below. **PenMount Gesture AP** is running.

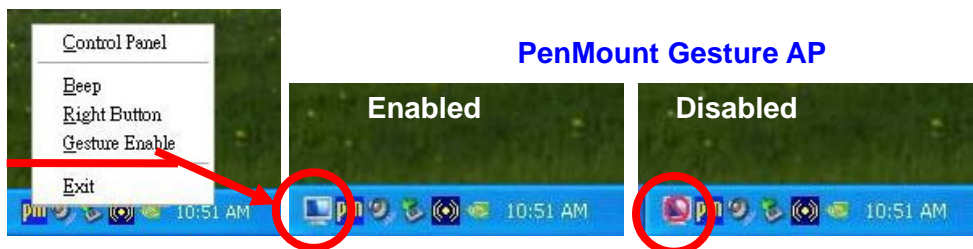

or

In **PenMount Control Panel**, select **Tools** tab and press **Gesture Enable** button. **PenMount Gesture AP** icon shows up in the notification area. **PenMount Gesture AP** is running.

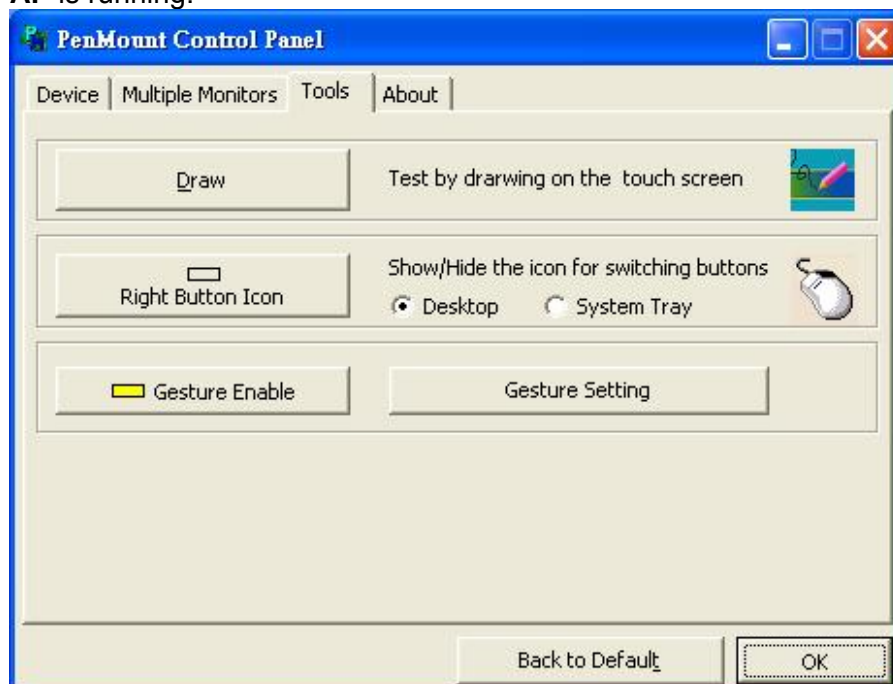

5.2. Configure PenMount Gesture AP

To configure PenMount Gesture AP.

1. Right-click on the **PenMount Gesture AP** icon in the notification area, select **Gesture Setting** from the menu that appears. See the illustration below.



or

Select **Tools** tab and click **Gesture Setting** button in **PenMount Control Panel**.

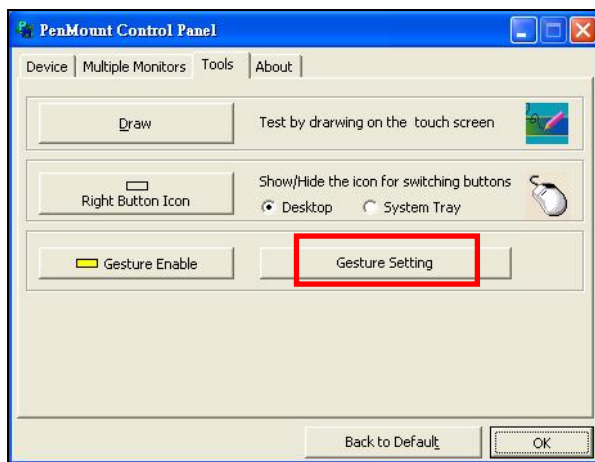

2. **[Gesture Setting]** window displays.

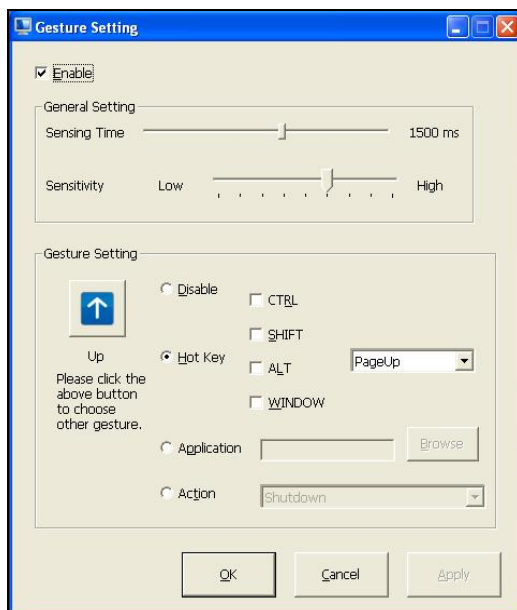

3. 15 PenMount Gestures are provided in total.

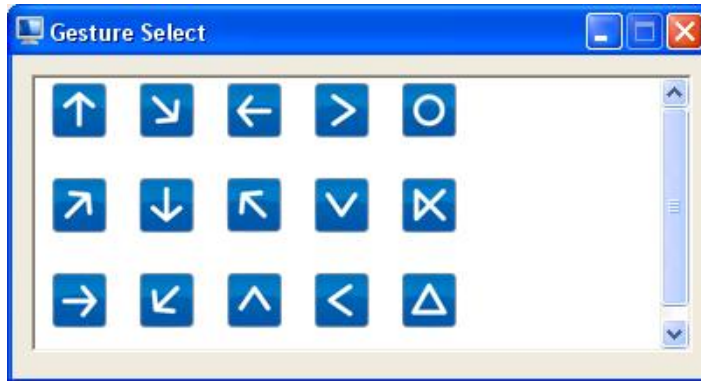

PenMount Gestures for Windows XP

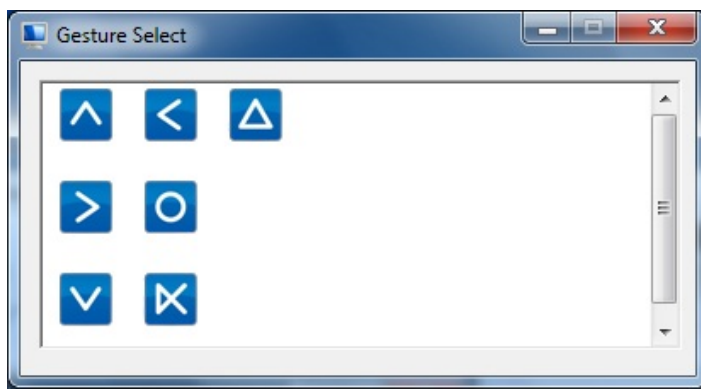

PenMount Gestures for Windows Vista / 7 / 8

4. In the [Gesture Setting] window, you can proceed to configure **PenMount Gesture AP**:

See picture below.

PenMount Gesture AP

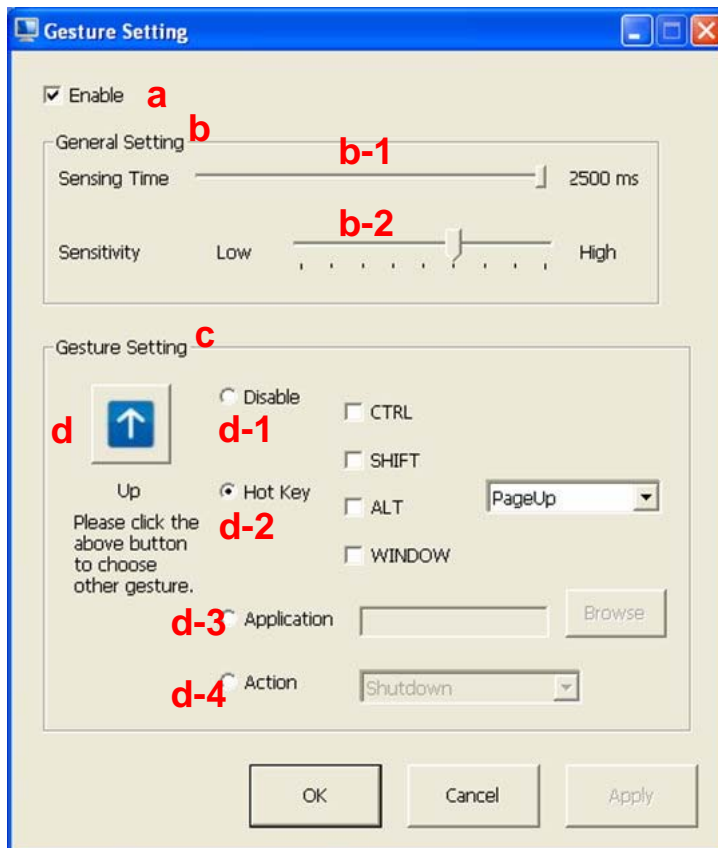

a. Enable/disable Check Box. Select/deselect the box to enable/disable PenMount Gestures.

b. General Setting Box

b-1. Sensing Time - Move the slider to adjust PenMount Gestures Sensing Time between 200 ms (0.2 sec) and 2500 (2.5 sec). The shorter the sensing time is configured, the faster the gesture has to be done.

b-2. Sensitivity – Move the slider to adjust how sensitive you want your finger stroke on the touchscreen to be sensed.

c. Gesture Settings Group Box. This group box allows you to individually configure each gesture.

d. Gesture Select Button. Press this button to select the specific gesture you are going to configure. When the gesture icon turns to blue, it is enabled. When it is gray, it is disabled. See the following for details.

d-1. Disable Button. When this button is selected, the gesture is disabled.

d-2. Hot-key Configure Button. Configure the hot-keystrokes for specific gesture. The hot-key can include up to 5 keystrokes. When that gesture is sensed, the configured keystrokes will be reported.

d-3. Application Invoke Button. Configure to invoke a specific application with particular gesture. So that when the gesture is sensed, the specific application will run.



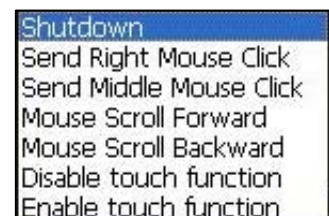











d-4. Action Configure Button. Configure to make use of PenMount Gesture AP's built-in shortcuts. So that when a particular gesture is sensed, a specific action will be taken. PenMount Gesture AP have the following shortcuts built in:



Note: For **Disable touch function**, after touch function is disabled, the mouse-pointer won't move following your finger sliding on the touchscreen and your finger tapping won't trigger any action, however, gestures will still be sensed.

(Note: If you select Disable touch function, the cursor will not react to finger movement on the touch screen and the tapping will not trigger any program action. However, the gesture recognition is still functioning.)

5.3. PenMount Gestures' Default Values in Windows XP

	Page Up		Page Down
	Backward (Left Arrow)		Forward (Right Arrow)
	Copy (Ctrl + C)		Paste (Ctrl + V)
	Undo (Ctrl + Z)		Delete
	Zoom in ([Pad] +)		Zoom out ([Pad] -)
	Rotate Counter Clockwise (Ctrl + L)		Rotate Clockwise (Ctrl + K)
	Open On-Screen Keyboard (Execute OSK.EXE)		Save Document (Ctrl + S)
	Close Program (Alt + F4)		