

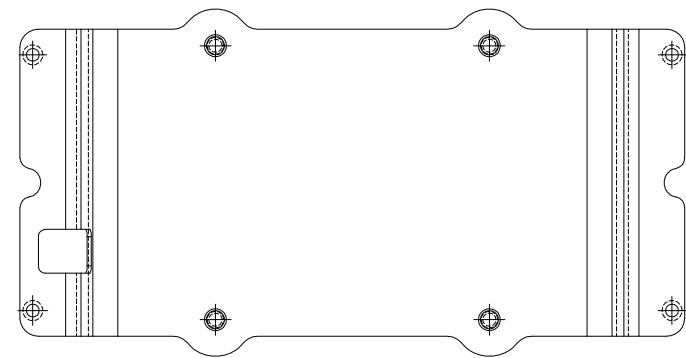

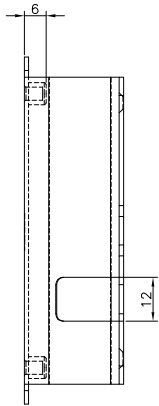

ITEM	DATE	REMARK	DESIGNED	APPROVED
1				
2				
3				

材質: SGCC
 厚度: 1.2mm
 外觀: 烤漆PMS-877C-02銀色

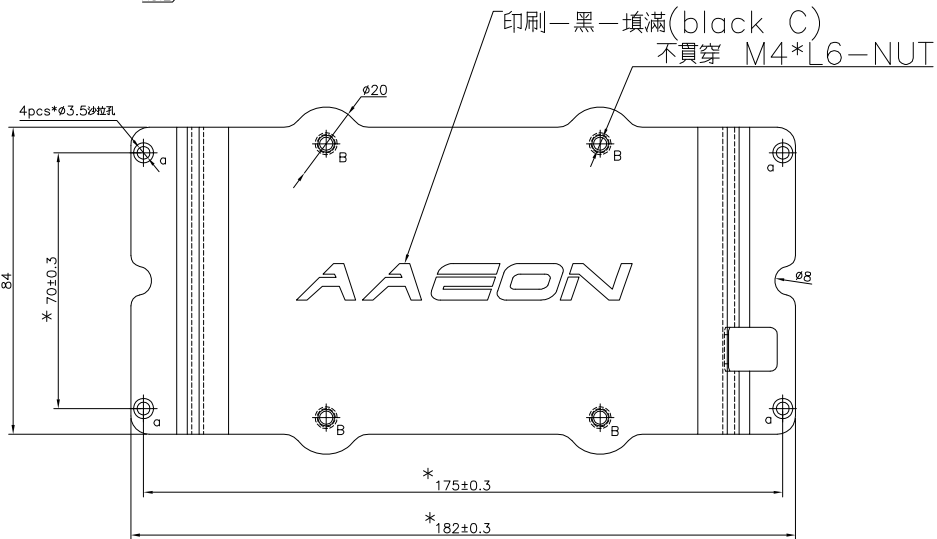
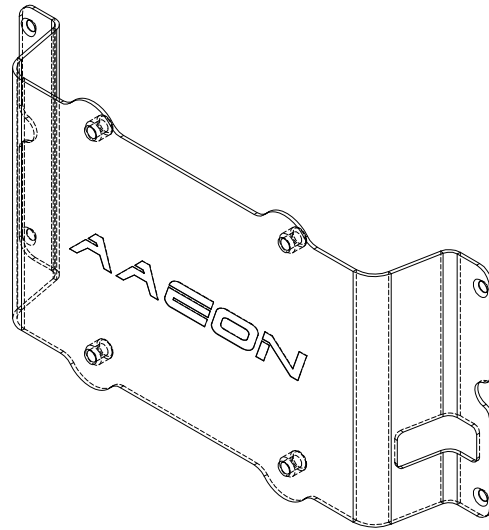
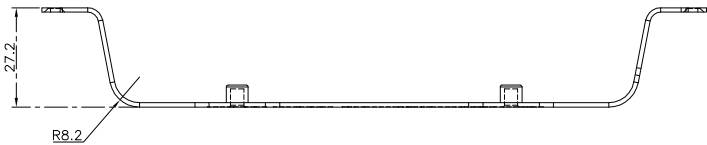

SAME:R0

GENERAL TOL. >0 ±0.1 >10 ±0.2 >50 ±0.3 >200 ±0.5 >500 ±0.8	MATERIAL: SGCC	PART No. M041073000			
	SPEC.: T1.2	DWG No. M041073000			
ANGLE TOL. ±0.5°	FINISH: pantone 877-02	APPROVED	CHECKED	DESIGNED	NAME VESA COVER
	UNIT: MM		TONY L	ET	MODEL No. ACP-1073
	SCALE:		102.07.24	102.07.24	REV. 0.0 SHEET: 1 / 1